

Caribbean Life

www.caribbeanlifeneews.com

BROOKLYN/STATEN ISLAND EDITION

Sept. 12—18, 2014

CNG

FREE

U.S., Grenada sign energy security initiative

By Nelson A. King

As part of the Caribbean Energy Security Initiative, the United States says it has signed a Memorandum of Understanding (MOU) with Grenada to “promote a cleaner and more secure energy future in the Caribbean.”

The U.S. Department of States said on Wednesday that Acting Special Envoy and Coordinator for International Energy Affairs, Amos Hochstein, and Grenadian Ambassador to the United States E. Angus Friday signed the agreement here on Aug. 27.

“The United States will work with Grenada on a pilot program that seeks to develop and apply a visionary approach to improving its energy sector, which includes integrating policy and regulatory reforms, and encouraging private sector investment in environmentally responsible and economically sustainable technologies,” said the State Department in a statement, adding that the MOU was announced by Prime Minister of Grenada Dr. Keith Mitchell at the Third U.N. Conference on Small Island Developing States (SIDS) in Apia, Samoa, on Sept. 1.

“This cooperation, which is integral to the Caribbean Energy Security Initiative announced by Vice President (Joseph) Biden,

Continued on Page 6



History maker

Rodneyse Bichotte became the first Haitian American to win a state Assembly primary. With the win, she'll likely take the seat in the November election. For complete coverage of Tuesday's vote, **see page 3**. Photo courtesy Rodneyse Bichotte

GUYANA BRIBE SCANDAL

Aussie miners: Kickbacks ordered

By Bert Wilkenson

An Australian mining company preparing to open a large-scale mine in Guyana has unwittingly handed the opposition a key elections issue on a platter by publicly condemning demands by government officials for bribes and inducements to help it get things done in the mineral-rich country.

Thanks to the successful filing of a no confidence motion by the seven-seat Alliance for Change (AFC) last month, general elections could be held later this year or early next year depending on whether parliament reconvenes from its summer break and votes on the issue in early October or whether the governing Indolent People's Progressive Party (PPP) decides to call an early date or not.

This week, Perth, Australia-based Troy Resources said in a statement that it absolutely won't pay any bribes to government officials and regulators to get things done in relation to a large gold mine it is preparing to open in the west of the country near Venezuela next year.

This is so because it is still subjected to Australian laws on graft, transparency, and corruption whether or not it is at home or outside of its Australian home base.

It is unclear whether company officials knew what kind of impact the company statement would have as nearly every group in the country, be it religious, political or civic, has complained about the level of graft and greed among top PPP officials

Continued on Page 6

KINGS

BRICKS • PAVERS • STONE
READY MIX CONCRETE

www.KINGSNY.com 1-877-40-KINGS

NOW OPEN!

2079 UTICA AVE

(BETWEEN M & N)



KINGS • 2079 UTICA AVENUE BROOKLYN NY 11213

GRAND OPENING

NICOLOCK
PAVERS

STARTING
AT

\$2 PER SQ FT



UTICA
AVE.
ONLY
WHEN YOU
PAY CASH

Have You Been In An Accident?

You May Be Entitled To Money Damages!

Car Accident Cases • Slips & Falls • Construction Accidents
Work Place Accidents • False Arrests • Medical Malpractice



JAMES ROSS
35 years experience

WILLIAM C. THOMPSON
Ret. Justice Supreme Court
Appellate Division Of Counsel To the Firm
Former NYS Senator
Former Regional Director NAACP

ARTHUR HILL
35 years experience

We have recovered millions of dollars for our clients.*

FREE Consultation • NO FEE Unless Successful

Ross & Hill, Esqs.

Your local community lawyers for the past 35 years!

718-855-2324 16 Court Street, 35th Floor
Brooklyn, NY 11241

Se Habla Español www.rossandhill.com

*Prior results do not guarantee a similar outcome - expenses payable at conclusion of case

Bichotte makes history with win over Tulloch

By Nelson A. King

A Haitian American candidate made history on Tuesday night by becoming the first politician of Haitian descent to win the Democratic Party Primary Election for a seat in the New York State Legislature.

Rodneyse Bichotte, who was born and raised in Brooklyn to Haitian immigrants, handsomely defeated Jamaican-born economist and accountant Rickie Tulloch by 20 percentage points to win the primary in the 42nd State Assembly District in Brooklyn.

Since New York is heavily Democratic, winners in the primary are considered shoo-ins to win the general elections in November.

With 100 percent of the polling precincts reported, Bischotte, who was the District Leader of the 42nd State Assembly District, garnered 47.4 percent, or 2,669 votes, to Tulloch's 29.7 percent, or 1,592 votes.

The other candidates in the race were Haitian Michele Adolphe, who received 800 voters, or 14 percent, and Guyanese Victor Jordan, who received 306 votes, or 5.7 percent.

"We did it!" exclaimed Bichotte. "I am humbled and exceedingly grateful to have received the confidence of the people of the 42nd Assembly District to serve as their next assemblywoman."

"Our success today at the polls would not be possible without the support and effort of a dedicated team of volunteers, campaign staff, and supporters who came together to make today's victory possible," she added.

Bichotte said during the past few months leading to Tuesday's victory, her campaign was able to put togeth-

er a widespread coalition of elected officials, unions, clergy and non-profits, "who believe that our community is in dire need of leadership in the state Assembly that will put their best interests at heart."

Tulloch had received the endorsement of the retiring Assemblywoman Rhoda Jacobs, whose 42nd Assembly District comprises Flatbush, East Flatbush and Midwood, among other Brooklyn neighborhoods.

But while Bichotte was successful at the polls, another Haitian American candidate was unsuccessful.

Lawyer and educator Rubain Dorancy lost soundly to another lawyer, African American Jesse Hamilton, for the 20th Senatorial District in Brooklyn.

Hamilton, the former legal counsel for Eric Adams who vacated the seat when he was elected Borough President, received 9,090 votes or 64.9 percent to Dorancy's 4,189 votes, or 29.9 percent. The other candidate, Haitian Guillermo Philpotts received 728 votes, or 5.2 percent.

"I'm glad that I ran on an issues-driven campaign," Dorancy told the Caribbean Media Corporation at his campaign headquarters on Nostrand Avenue in Brooklyn on Tuesday night.

"The most important thing is that the community's voices were heard," he added. "At the end of the day, the voters carried out the vote. I feel relieved."

Hamilton, on the other hand, said he was "humbled and honored by the trust voters have placed in me tonight, and I'll spend every day in Albany (the state's capital) working to live up to it."

Continued on Page 6



Some members of VincyCares take a minute out from the school-supplies drive to pose for Caribbean Life.

Photo by Nelson A. King

Popular Vincentian group holds successful school-supply drive

By Nelson A. King

The popular Internet-based Vincentian group, VincyCares, has expressed great satisfaction with its recent fund-raising drive to provide school supplies for primary school children in St. Vincent and the Grenadines.

"VincyCares' dream is to make sure that school supplies do not come between a child and his or her education, thus leveling the playing field for more equal opportunity for a proper education," VincyCares president Franklyn "Supadex" Richards told Caribbean Life after the group staged its latest drive on Aug. 30 at Standard Shippers in Brooklyn.

The shipping company is owned by Vincentian native Gideon "Fessy" Yorke.

Richards, who hails from Calder, said the purpose of the annual drive, named after VincyCares' late board member Taswya Cambridge,

is aimed at providing school supplies to every needy child in St. Vincent and the Grenadines.

"VincyCares' dream is to make sure that school supplies do not come between a child and his or her education."

"This year's event was much bigger and better than previous years, which adds to the trend of a growing support from the Vincentian and non-Vincentian community in the Diaspora," said Richards about the fifth annual event.

"This year also saw a wider variety of local dishes — blackfish, roast breadfruit, bakes, saltfish, tri tri cake, conch, peleau, crab and callaloo, bread and cassava pudding, corn soup, and bread nut," he added

about the mouth-watering delicacies.

Richards said most of the food was contributed by supporters, and well as well wishers and members of VincyCares.

Additionally, he said the sound system was supplied — free of charge — by Nolan Bulze, of the Brooklyn-based Vincentian band Solid, with DJs SupaEyes, Kemmy, Yung Hova, Bajan King, and Blondie, and announcer Atiba Williams.

"It was a festive mood that saw Vincentians from as far as California coming to Brooklyn to support a worthy cause," said Richards, adding soca artistes Luta and Fireman were also on hand in giving the crowd "a mini performance leading up to the show that Saturday night" at Café Omar in Brooklyn.

He said VincyCares has successfully distributed school supplies to every primary school in St. Vincent

and the Grenadines "and is continuing the trend to supply school supplies where they are needed."

In addition to school supplies, he said VincyCares has awarded nine scholarships to student throughout St. Vincent and the Grenadines "and will continue to provide scholarships as long as the general public continues to support our cause."

"We have seen firsthand the impact the scholarships have on the students' overall performance, which further strengthen our determination to help those we can to better their lives, hence their future," Richards said.

"The best part of this whole experience is to see how hard the Board of Directors and members came together and worked tirelessly and unselfishly for the future of the children of St. Vincent and the Grenadines," he added.

CARIBBEAN ROUNDUP

Updated daily at www.caribbeanlifeneews.com

THE NEWS FROM BACK HOME

Antigua

The Antigua and Barbuda government says more than 12 major conglomerates in China have expressed interest in doing business in the Caribbean state.

During a recent visit to China, Prime Minister Gaston Browne told a group of chief executive officers and presidents of corporations attached to the Department of Commerce of Shandong Province that Antigua is part of a network of trade agreements that allow goods to enter the European Union, Canada and the United States.



“Antigua and Barbuda has a stable investment environment. When you invest in our country, there is no need to worry about a fall in the value of your products, in fact value will increase instead,” Browne said in a statement. He said investing in Antigua and Barbuda is also a gateway to other markets within Latin American and the Caribbean.

Deputy Director General of Shandong Department of Commerce, Yan Zhaowan said that Chinese business leaders were impressed with Browne’s presentations and the economic possibilities in Antigua and Barbuda, the statement said. Yan said his division sees the possibility of investing in tourism, information communication technology (ICT), agriculture and manufacturing.

Dominica

Dominica says while it will not impose a travel ban on people arriving from Africa, it will screen new students arriving in the country from West Africa where an outbreak of the deadly Ebola virus has resulted in more than 1,000 deaths.



Chief Medical Officer Dr. David Johnson, speaking on the state-owned DBS radio, said



First family flies

The DeBlasio family jumps and waves at the West Indian American Day Carnival on Labor Day. See story on page 44.

Photo by Paul Martinka

that a meeting had been held involving various stakeholders to look at the threat to the island, for which there is no known cure.

Dr. Johnson said that the advice is that “we cannot go down the route of imposing travel restrictions at this time.”

“So we would not advise any restriction on travel or on trade at this time,” he said noting that a screening questionnaire for West African nationals entering Dominica would be implemented.

He said based on the information provided during the screening process “we will take it to the next level in terms of isolation and management of those individuals.”

The chief medical officer said

several countries, including Dominica, were now seeking to establish the appropriate isolation facilities to manage any case that may occur.

There are several students from Africa and Nigeria who attend medical school in Dominica.

Haiti

The United Nations has launched the second phase of a vaccination campaign against cholera in Haiti where health officials say more than 8,000 people have died since the outbreak in 2010.

The campaign initiated and implemented by the Haitian authorities until September, is part of the broader framework of the national plan for the elimination of cholera

in Haiti.

It aims to vaccinate 200,000 people living in the communes where the disease persists in particular the department of Artibonite.

Earlier this year, nearly 1,500 Haitians filed a lawsuit in the United States seeking compensation from the United Nations for victims of the cholera outbreak that sickened more than 600,000 people.

They claim that the disease was brought to the country by the UN peacekeepers from Nepal, where the disease is endemic.

UN Secretary General Ban Ki-moon rejected a previous claim for



compensation for cholera victims, citing diplomatic immunity, but announced a US\$2.27 billion initiative to help eradicate cholera in Haiti in December 2012.

In August 2013, a similar vacation campaign was conducted by the Haitian government with the support of the United Nations and was able to reach a population of about 107,000 people.

Grenada

Grenada’s Prime Minister Dr. Keith Mitchell says the decision by St. George’s University (SGU) in Grenada to inject more than EC\$700 million into an expansion program will have enormous impact for the university and for the country.

Dr. Mitchell said since returning to office a year and a half ago his administration has been working diligently to improve the business climate in Grenada and “we have vigorously promoted new investments.”

He said it is in this new environment the university, which has been operational in Grenada for the past 40 years, “has attracted such a huge and unprecedented new deal.”



Dr. Mitchell said among the new investments will be the establishment of a teaching hospital, noting “such a venture will open a new frontier in medical research and technology and provide training for generations of medical practitioners.”

Guyana

The Opposition grouping, A Partnership for National Unity (APNU) has called on President Donald Ramotar to uphold the pledge he made to hold local government elections “within one year of the 2011 general election.”

Local government elections were

Continued on Page 16

REMOVING IMMIGRATION NIGHTMARES

There are solutions to problems immigrants frequently experience.

Among the problems and solutions are the following:

1. GETTING MARRIED TO A US CITIZEN OR GREEN CARD HOLDER AND BEING ABUSED OR ABANDONED BY THE SPOUSE
2. PARENTS OF US CITIZEN WANTING TO WORK AND MAINTAIN THEIR CHILDREN
3. ILLEGAL ENTRY INTO THE US
4. ILLEGAL REENTRY AFTER DEPORTATION
5. WORK PERMIT AND GREEN CARD FOR CHILDREN AND YOUNG PERSONS
6. CRIMINAL RECORDS: WAIVERS AND PARDONS
7. REMOVING 2-YEAR CONDITIONAL GREENCARD
8. ASYLUM PROBLEMS AND DEPORTATION ORDERS
9. APPROVALS AND VISA BULLETIN PROBLEMS
10. NOTICE TO APPEAR (NTA) IN IMMIGRATION COURT AND IMMIGRATION COURT PROCEEDINGS
11. DO YOU NEED A WORK PERMIT, IDENTIFICATION CARD AND FOREIGN TRAVEL PERMIT?
12. CBP AND TSA PROBLEMS



NO ATTORNEY'S FEE
UNLESS APPROVED
FOR DHS CASES

1179 Eastern Parkway
1st Floor Brooklyn, NY 11213
(Between Utica and Rochester)
Take 4 or 3 Train to Utica / A Train to Utica to connect to Bus 46

SALIS LAW P.C.

PHONE: (212) 655-5749
(212) 542-0214 • (212) 810-7111
(212) 514-6141

FAX: (212) 742-0549

mail@salislaw.com • www.salislaw.com



AETNA BETTER HEALTH[®] OF NEW YORK

Home. Where you belong.



With our new managed long-term care (MTLC) plan, you will enjoy...

- Home and personal care services when YOU need it
- Adult day care services
- Transportation to and from health care appointments
- Physical therapy
- Personal care manager who oversees your needs
- Managed long-term care services

Best of all, you can enjoy all of these things from the comfort of your own home; In your neighborhood with the view you have learned to enjoy.

Keeping you healthy. Keeping you home.

Here to help

1-855-456-9126
(TTY/TDD: NY Relay 711)

24 hours a day, 7 days a week

www.aetnabetterhealth.com/ny

You can get this document in Spanish, or speak with someone about this information in other languages for free. Call Member Services at 1-855-456-9126 and TTY/TDD is 7-1-1, 24 hours a day, 7 days a week. The call is free. Usted puede obtener este documento en español, o hablar gratuitamente con una persona en otros idiomas sobre esta información. Llame a Servicios al Miembro al 1-855-456-9126 y TTY/TDD al 7-1-1, 24 horas al día, siete días de la semana. La llamada es gratis.

Greener Grenada pact

Continued from cover
 during his trip to the region in June, will serve as an example to lead the way to a cleaner energy future for the Caribbean region and for small islands around the globe," it continued.

"The best practices and lessons learned from the comprehensive energy reform approach in Grenada will be helpful to other islands looking to reform their energy sector in support of environmental, economic, and social objectives," the statement said.

The State Department said the United States is "committed" to working with SIDS on "critical global issues," including climate change and ocean conservation, as well as the islands' sustainable development, energy security, food security and health issues.



Prime Minister Dr. Keith Mitchell.
 Associated Press / Miraflores Press, Francisco Batista, HO

Bribes

Continued from cover
 and their audacious displays of wealth on a daily basis.

Troy Resources more than hinted that some key documents officials should have signed off on already have not been attended to expeditiously so it took the unusual step of going public with its complaint in a newspaper advertisement about plans for the mine and the way it operates at home and abroad.

"It should be noted that any form of payment or inducement to individuals and organizations to expedite, seek favors, get unfair

advantage or to circumvent official procedures in any country of operation is unlawful under Australian corporate law and any breach is regarded as a serious crime which may result in a prison sentence for any company officer engaging in this practice."

The statement comes as the firm announced that it has already spent \$5 million on heavy duty equipment it would need at its mine in the western jungles while it awaits the signing of its mineral agreement with government to allow it to expedite the construction of its mine site and begin mining as planned in 2015.

The firm recently announced that it had secured \$87 million in financing to build its open pit mine, plants, and tailings waste ponds but warned that it is not in the habit of paying inducements to get things done.

The miners association of which the company is a member chimed in this week saying that it is quite "aware of the frustrations" Troy is experiencing, noting that it has raised the issue at recent meetings with executives.

Spokesman Colin Sparman said that the company "has faced a lot of hurdles but is determined not to bribe anyone to get things

done. They have told us that they don't do things that way and are very frustrated with the red tape in Guyana," Sparman said.

Opposition parties and rights groups have persistently complained about the level of corruption in the country. The issue is the main reason a parliamentary opposition party successfully filed a no confidence motion against government last month. The issue is to be debated in the opposition controlled 65-member parliament in early October. A successful vote will result in general elections in 90 days and about two years before constitutionally due.

Primary

Continued from Page 3

"Tonight's results clearly show that voters in this district demand a proven progressive who will continue Borough President Adams' long legacy of delivering for our neighborhoods — and I'm proud to answer the call," he added.

"I have big shoes to fill, but with the help of supporters, resi-

dents, and community leaders like Rubain Dorancy, I look forward to making progress on all the issues working families care about as our next state senator," she continued.

Two other Caribbean American candidates were also successful in the Primary.

State Sen. John L. Sampson, whose father is Guyanese, survived a challenge as three other candidates split votes for the 19th Senatorial District in Brooklyn.

Sampson is under federal indictment on charges that he embezzled more than \$400,000 from the sale of foreclosed homes. He said he is vigorously fighting the charges.

Sampson received 7,218 votes, or 54.2 percent; Dell Smitherman received 3,981 votes, or 29.9 percent; Sean Henry received 1,668 votes, or 12.5 percent; and Elias Weir received 458 votes, or 3.4 percent.

"We had the governor, the mayor and some of my colleagues in the

Assembly who didn't want to see this happen," Sampson told supporters at the Thomas Jefferson political club in the Canarsie section of Brooklyn on Tuesday night.

"Prosperity breeds friends, adversity proves it," he added. "It is going to be a different John Sampson."

In Queens, voters in the 14th District turned against state Sen. Malcolm A. Smith, who is accused of bribery in his bid for the 2013 New York City mayoral ballot.



Mix It Up Strawberry Chocolate-tini™



Delicious Watermelon Party™



Swizzled Mixed Fruit Chocolate-tini™



Watermelon Kiwi Summer-tini™



Mango Kiwi Summer Festival™

SUMMER SWEET SAVINGS
SAVE \$5.00 OFF
 your next order of any Chocolate Dipped Fruit Box or Arrangement
 Code - SMBK0914 Exp 09/15/14
 Offer Valid Only At Participating Locations. Can Not Be Combined With Any Other Offer. Valid Through Sept 15th 2014

993 Flatbush Ave.
 Brooklyn NY 11226
 (718) 484-3800

1446 86th St.
 Brooklyn NY 11228
 (718) 837-3784

224 Livingston St.
 Brooklyn NY 11201
 (718) 522-6300

5114 Avenue N
 Brooklyn NY 11234
 (347) 587-7500

1736 Sheepshead Bay Rd.
 Brooklyn NY 11235
 (718) 535-7909

CUSTOMER FAVORITE

BEST-SELLING STYLES, COLORS & SIZES ALWAYS IN-STOCK

NOW THROUGH SUNDAY, SEPT. 14

30% - 75% OFF STOREWIDE

EXTRA 20% OR 15% OFF† WITH YOUR MACY'S CARD OR PASS

†EXCLUSIONS APPLY; SEE PASS.

FREE SHIPPING AT MACYS.COM + EXTRA 20% OR 15% OFF + NEW! FREE RETURNS AT MACYS.COM!

Free shipping with \$99 purchase. Use promo code: *FAVES* for extra savings; offer valid 9/10-9/14/2014. Exclusions apply; see macys.com for details. Free returns by mail or in-store. U.S. only. Exclusions apply; details at macys.com/freereturns



WOW! PASS

EXTRA SAVINGS ON ALL SALE & CLEARANCE APPAREL! (EXCEPT SPECIALS & SUPER BUYS)

EXTRA 20% OFF

SELECT SALE & CLEARANCE APPAREL FOR HIM, HER & KIDS
EXTRA 15% OFF ALL SALE & CLEARANCE FINE & FASHION JEWELRY, WATCHES, COATS, SUITS, DRESSES, IMPULSE, INTIMATES, SWIM FOR HER; MEN'S SUIT SEPARATES & SPORTCOATS;
SELECT SHOES & HOME ITEMS

Also excludes: Everyday Values (EDV), Doorbusters, Deals of the Day, furniture, mattresses, floor coverings, rugs, electrics/electronics, cosmetics/fragrances, athletic shoes for him, her & kids, Dallas Cowboys merchandise, gift cards, jewelry trunk shows, New Era, Nike On Field, previous purchases, special orders, selected licensed depts., special purchases, services. Exclusions may differ at macys.com. Cannot be combined with any savings pass/coupon, extra discount or credit offer except opening a new Macy's account. EXTRA SAVINGS % APPLIED TO REDUCED PRICES.

TEXT "CPN" TO 62297 TO GET COUPONS, SALES ALERTS & MORE!

Max 3 msgs/wk. Msg & data rates may apply. By texting CPN from my mobile number, I agree to receive marketing text messages generated by an automated dialer from Macy's to this number. I understand that consent is not required to make a purchase. **Text STOP to 62297 to cancel.**

Text HELP to 62297 for help. Terms & conditions at macys.com/mobilehelp

Privacy policy at macys.com/privacypolicy



00025705100318530112

VALID 9/10-9/14/2014

★ *macy's*

the magic of
macy's
.com



SALE PRICES IN EFFECT 9/10-9/14/2014, EXCEPT AS NOTED.



OPEN A MACY'S ACCOUNT FOR EXTRA 20% SAVINGS THE FIRST 2 DAYS, UP TO \$100, WITH MORE REWARDS TO COME. Macy's credit card is available subject to credit approval; new account savings valid the day your account is opened and the next day; excludes services, selected licensed departments, gift cards, restaurants, gourmet food & wine. The new account savings are limited to a total of \$100; application must qualify for immediate approval to receive extra savings; employees not eligible.

Jamaica's Maroons champion UNESCO award

By Vinette K. Pryce

A group of Maroons in Jamaica are the winners of a United Nations' award of excellence for the outstanding Bench Drum submission they entered in the handicraft category judged in the Dutch and English-speaking Caribbean region.

The Charles Town Maroon Council beat out 26 entrants to win the United Nations Educational Scientific and Cultural Organization (UNESCO) award of excellence.

A statement from the three member jury that met in Curaçao to evaluate the entries from numerous countries said the African instrument was chosen "for its craftsmanship and cultural content."

The drum is "a standalone object that talks about music using noble materials such as local woods and goat skin," the jurors said.

They noted that in addition to providing rhythm, the use of the drum in spiritual rituals is significant in calling on the African ancestors.

Colonel Frank Lumsden, the head of the Charles Town Maroon community, explained that the drum was designed to resemble a bench so that the ancestors could "hide it in the open" from the colonizers who had forbidden the use of the drums.

Maroons in Jamaica claim ancestry in Ghana, Africa where the bench drum is an integral instrument attributed to victories by the Ashanti people over the British invaders.

Highlighting the national value of the international honor Secretary-General of the Jamaica National Commission for UNESCO Everton Hannam said the award "aims to ensure that when consumers buy

awarded handicrafts they receive high quality, culturally authentic products that have been manufactured in a socially-responsible manner with respect for the environment."

According to the spokesperson for UNESCO, the award for handicrafts was established to "encourage artisans to produce handicrafts using traditional skills, patterns, and themes in an innovative way in order to ensure the continuity and sustainability of these traditions and skills."

Based in Paris, France with more than 50 field offices located throughout the world, UNESCO is an agency within the United Nations that is responsible for promoting peace, social justice, human rights, and international security through international cooperation on educational, science and cultural programs.



Colonel of the Charles Town Maroons Frank Lumsden, left, receives the UNESCO Award of Excellence for Handicraft for the Bench Drum from Secretary-General of the Curaçao National Commission for UNESCO, Marva Browne. Sharing in the moment are, from left, UNESCO director Jamaica Christine Anne Norton and Barlow White who made the winning drum. Jamaica Information Service



✓ Studios, 1,2 & 3 Bdrms Available ✓ Furnished & Unfurnished
 ✓ Monthly Short and Long Term Leases

- Some with Free Gas, Gym, Laundromat
 - Brand New Kitchens and Bathrooms
 - 24 Hr. Maintenance and Emergency Repairs
 - 24 Hr. Surveillance All Site
 - Professional and Friendly Staff
- Clean, Secure, Comfortable & Affordable*



ZARA REALTY HOLDING CORP.
 Visit us at: www.zararealty.com
 166-07 Hillside Ave. Jamaica, NY 11432
 Queens: **718-943-1150** or **718-291-3331**
 Nassau: **516-292-6011**

Present this coupon & receive up to \$200

Offer expires Dec. 2014. Not to be combined with any other offer.

Never forget.

We are always there for you.

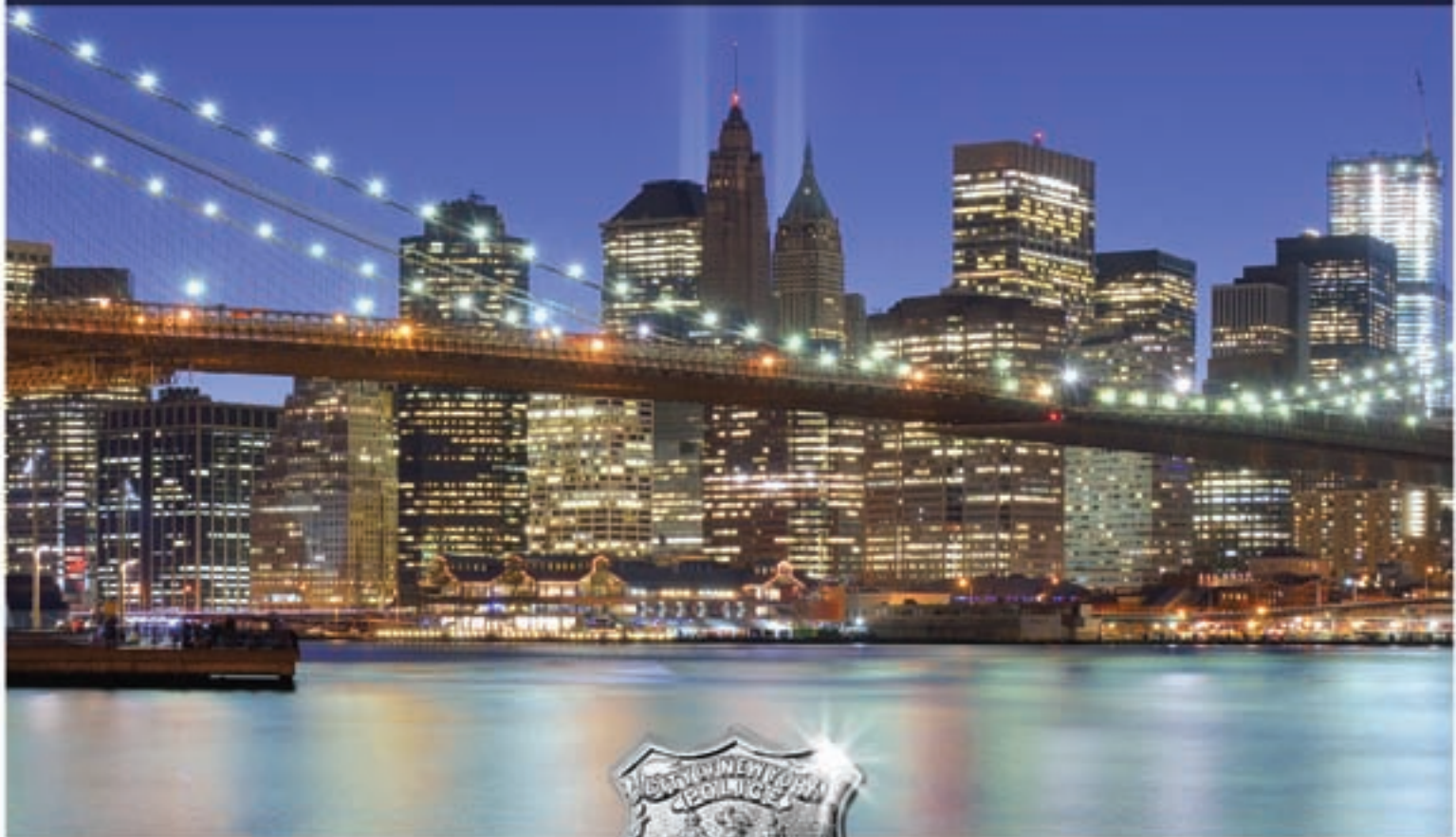

Patrolmen's Benevolent Association
of the City of New York



125 Broad Street, 11th Floor, New York, NY 10004 • 212-233-5531

Patrick J. Lynch, President

www.nycpba.org

Pres. Obama follows Bush's Iraq playbook

By Sheldon Richman

United States politicians are exploiting the gruesome beheadings of two American journalists to whip up war fever against ISIS, the "criminal gang" masquerading as an organization of devout Sunni Muslims that controls large parts of Syria and Iraq. The American propaganda campaign seems to be working if recent polls are accurate.

No decent person is anything but appalled by those executions. But are they grounds for the United States to go to war?

No, they are not. Barack Obama says his job is to protect Americans wherever they are,

but he doesn't cite the source of this power. No such power is implied in the president's oath of office, which obligates him only to "faithfully execute the Office of President" and to "preserve, protect and defend the Constitution."

Article II of the Constitution vests the "executive power" in the president, but that just means he has the power to execute laws passed by the legislative branch. There is no blank-check language about protecting Americans, particularly outside the country.

Section 2 of that article of course says the president is "commander in chief" of the armed

forces, but no matter how many times the war party repeats that phrase, it cannot be reasonably interpreted as unilateral power to take the country to war. Article I reserves the power to declare and finance wars to Congress alone.

True, since the end of World War II, presidents have assumed the unilateral power to make war, and most members of Congress have been more than happy to defer. But this does not mean that we who understand the danger of autocracy should acquiesce.

Obama says he can go to war against ISIS anywhere without "authorization" from Congress. (No one in government or the media uses the word declaration.) In his interview on Meet the Press, Obama said,

I'm confident that I have the authorization that I need to protect the American people. And I'm always going to do what's necessary to protect the American people. But I do think it's important for Congress to understand what the plan is, to have buy in, to debate it.

But understanding, buying in (whatever that means), and debat-

ing are not the same as authorizing through a declaration of war. Just because most members of Congress would hate to sign off on a years-long, offensive war less than two months before an election, that's no excuse for Obama to exercise autocratic powers.

Note that Obama speaks of protecting the American people. He means Americans both abroad and at home. Americans of course are free to travel anywhere. If the U.S. government is to have the power to protect or avenge them abroad, it will have to be able to exercise military power globally. Such imperial power, which the government has long exercised, should disturb peace- and freedom-loving Americans precisely because it creates the potential for perpetual war, invites retaliatory terrorism, and requires high government spending and borrowing.

It may be taken for granted that a president can go to war when an American is killed overseas, but that kind of power is too dangerous to accept meekly. Americans, especially war correspondents, should be on notice

that they travel at their own risk. This may sound callous, but the alternative is a global empire that we cannot afford either in blood or treasure.

What about protecting Americans at home? Here the irony of Obama's position is striking. U.S. intervention in the Middle East is what endangers Americans at home. Osama bin Laden's al-Qaeda hit Americans here because for many years the U.S. government had perpetrated and supported violence against Arabs (Palestinians, Iraqis, Egyptians, Lebanese and others) — and it still does.

No al-Qaeda affiliate existed in Iraq before George W. Bush launched his invasion and occupation in 2003. ISIS is an offshoot of al-Qaeda, and its execution of the two journalists was retaliation for recent U.S. bombings in Iraq. No doubt those murders were intended also to goad Obama into sending American forces, which would boost ISIS's recruitment and prestige. Bin Laden did the same thing, bragging he would bleed the United States bankrupt through long years of war. He succeeded.

Caribbean Life

Founded 1990 • Published by Community Newspaper Group
Corporate Headquarters: One MetroTech Center North, Suite 1001, Brooklyn, NY 11201

NEW YORK PRESS ASSOCIATION
NYPA

CEO: Les Goodstein
PRESIDENT AND PUBLISHER: Jennifer Goodstein
ASSOCIATE PUBLISHER: Ralph D'Onofrio
EDITOR EMERITUS: Kenton Kirby
ASSOCIATE EDITOR: Kevin Williams

Contributing Writers: Azad Ali, Roderick J. Broome, Fabian Burrell, Tangerine Clarke, Robert Elkin, Patrick Horne, Nelson King, Donna Lamb, Tequila Minsky, Vinette K. Pryce, George H. Whyte, Bert Wilkinson, Lloyd Kam Williams

GENERAL INFORMATION (718) 260-2500

This newspaper is not responsible for typographical errors in ads beyond the cost of the space occupied by the error. All rights reserved. Copyright © 2014 by Courier-Life, Inc., publishers. Caribbean Life is protected by Federal copyright law. Each issue of Caribbean Life is registered with the Library of Congress, Washington, D.C. The Caribbean Life, its advertisements, articles and photographs, may not be reproduced, either in whole or part, without permission in writing from the publisher except brief portions for purposes of review or commentary consistent with the law.

LETTERS TO THE EDITOR are welcome from all readers. They should be addressed care of this newspaper to the Editor, Caribbean-Life Publications, 1 MetroTech Center North, Brooklyn, New York 11201, or sent via e-mail to caribbeanlife@cnglocal.com. All letters, including those submitted via e-mail, MUST be signed and the individual's verifiable address and telephone number included. Note that the address and telephone number will NOT be published and the name will be published or withheld on request. No unsigned letters can be accepted for publication. The editor reserves the right to edit all submissions.



GIVE. ADVOCATE. VOLUNTEER. LIVE UNITED™



Want to make a difference? Find out how at LIVEUNITED.ORG.

Taking one for the team — when necessary

So, as we hit the pivotal two-month mark prior to November's mid-term elections, the buzz around control of the United States Senate has predictably intensified. Pundits and pollsters across the board seem inclined to giving an edge to Republicans to emerge from the elections with a slim advantage of maybe two seats. All of them, though, are hedging bets and noting how much Election Day turnout of the respective party bases could alter the picture. Even crackerjack Democratic strategist James Carville commented in a television interview the other day that if the GOP doesn't have itself a Senate majority after the dust clears in November, its leaders would seriously have to look into what's wrong with their party.

Carville, like other observers of the ebb and flow of American party politics, made note of how traditionally dicey it has been for the party of an incumbent president in the sixth year of a two-term presidency. Even that darling of all conservative darlings, Ronald Reagan, saw his Republicans lose the Senate in 1986, his sixth year. It is rational to assume that, consider-

ing the anti-Obama venom that has bubbled up over this president's six years in office, 2014 figures to be tough sledding for Democrats. Republicans having done a no-holds-barred number in gerrymandering solidly hard-right Congressional Districts across the electoral landscape to keep them red for the foreseeable future, control of the House continues to be a non-issue. But given what the president (not to mention we, the people) has already had to endure with just one Capitol Hill chamber under GOP control, it is no endearing prospect, the full legislative branch committed to the kind of obstructionist, renegade M.O. that now typifies the House GOP.

Naturally, much of the focus in these Senate majority-control stakes is on toss-up states like North Carolina, Iowa, New Hampshire, and others. But what ensues in the normally safe Republican stronghold of Kansas suddenly figured to be a big deal in the Election-night math, after some developments a few days ago shook up the race in which veteran Republican Pat Roberts is up for re-election. The Tea Party supposedly viewed Roberts as coming up short in far-right

Viewpoint

By Les Slater

style and substance and mounted a primary challenge, which he beat back. Even so, the scuttlebutt was that support for Roberts in the state wasn't what it used to be, compounded perhaps by reports that he didn't live in the state he represents. Those headwinds, though, didn't look strong enough to prevent Roberts from defeating his Democratic opponent, Chad Taylor. But complicating matters was the presence in the race of Greg Orman, an independent candidate who, polls showed, was a stronger opponent for Roberts than the Democrat. Last week, when Taylor announced his withdrawal from the race, the ground shifted dramatically in Kansas. And the possibility of a non-Republican being elected to the Senate for the first time since the 1930s grew instantly stronger — with whatever the implications for reconfiguring the GOP game plan to assume Senate control next January. True

to form, the state's Republican secretary of state issued a ruling that the Democratic candidate's name must remain on the ballot.

The Democrat's decision to get out of the way is worthy of applause whether or not what has all the appearances of a nakedly political move by the secretary of state will stand (the candidate withdrew a full two months before the election, for heaven's sake) — even if there was some friendly persuasion required to seal the deal. Being adult, pragmatic and public-spirited about such scenarios has been frequently shown to be beyond the capacity of players involved.

Taking one for the team is an off-limits concept for those who regard politics as a "me first" pursuit. Over the years we've had some showcase examples of ignoble conduct when there was a clear need for doing the opposite. Because of how it probably affected the course of early 21st century American history, the obstinate refusal of Ralph Nader to withdraw from the presidential ballot in Florida in 2000 remains a high-ranking instance of ego trumping the public good.

Nader's absence from the bal-

lot would very likely have meant Florida's secretary of state being denied a spotlight turn in that vote count debacle and, later, Supreme Court conservatives not being called upon to hand the presidency to George W. Bush.

We'll see whether the Democrats' thanks to candidate Taylor will extend to stymieing this year's GOP grab for Senate control. Or if, conversely, Republicans will be looking to declare Taylor Public Enemy Number One for being key in having those GOP ambitions frustrated. Either way, who would have thought that in steady-as-she-goes solidly red Kansas, there would be suspense surrounding what voters do come November?

Historically, mid-term elections are viewed as a presidential referendum. Based on all that has preceded them, the mid-terms this year will probably reflect anti-administration feeling to a degree equal to or surpassing some of the celebrated instances of presidential disfavor in the past. The calculus, more so if Republicans gain Senate control, doesn't bode well for even a moderately productive final two years for this White House incumbent.

EASIER THAN HITTING YOUR WAY OUT OF A PAPER BAG

PLAY THE HIT SERIES OF SCRATCH-OFFS AND LET THE HITS BEGIN. GOOD THINGS HAPPEN IN AN INSTANT.®

NEW YORK LOTTERY

©2014 NEW YORK LOTTERY. PLEASE PLAY RESPONSIBLY. YOU MUST BE 18 YEARS OR OLDER TO PURCHASE A LOTTERY TICKET. NYLOTTERY.NY.GOV

Health Fair Hosted By New York Community Hospital

Member
 ┌ New York-Presbyterian
 └ Healthcare System
 affiliate Weill Cornell Medical College

New York Community Hospital is a member of New York Presbyterian Healthcare System and an affiliate of the Weill Cornell Medical College. The hospital has a dedicated team of over 150 physicians, including Internal Medicine, Cardiology, Gastroenterology, Vascular Surgery and many more specialties. The Emergency Department is a NYC EMS 911 receiving hospital and a NYS DOH designated Stroke Center. We are the proud recipient of the American Heart Association's "Gold Plus Achievement Award" for Exemplary Stroke Care, and maintains consistently low ED waiting times. The hospital offers Kosher meals supervised by the Vaad Harabanim of Flatbush. There is a Bikur Cholim furnished apartment adjacent to The

Hospital for those that need to stay over Shabbos or Yom Tov.

On Sunday, September 14th, New York Community Hospital will host its first health fair from 11am-2pm. The entire community is invited to participate. It will take place right in front of the hospital, which is located at 2525 Kings Highway. There will be health screenings, such as blood pressure and body mass index. Nutritionists will be available to answer your questions and podiatrists will be offering consultations. An ambulance will be on site for children to tour and there will be free refreshments for all. For more information about this event, please call 917-327-8261 or email info@signatureeventsny.com

PERSONAL LOANS AVAILABLE



BAY RIDGE FEDERAL CREDIT UNION

Payment	Amount Financed	No. of Payments
\$220*	\$10,000	60
\$110*	\$5,000	60
\$55*	\$2,500	60
\$22*	\$1,000	60
Higher Loan Amounts Available		
\$330*	\$15,000	60

Apply Online
www.bayridgeloads.org
718-680-2121

MAIN OFFICE : 1750 86th Street, Brooklyn, NY 11214 • (718) 680-2121
BRANCH : 1609 Avenue Z, Brooklyn, NY 11235 • (718) 934-6809

* Rates are based on 8.45% Annual Percentage Rate with automatic loan payments for a term of 60 months. Rates are based on credit worthiness. Other rates and terms available. Higher loan amounts available. Credit Union membership eligibility is required.

KINGSBOROUGH Community College

Kingsborough's Office of Continuing Education serves the diverse needs of the community with courses designed by learning experts and taught by industry professionals. For those who are considering a career change, seeking professional advancement or simply looking to enrich their lives, continuing education provides the tools to meet these needs.

ESL TASC™
ACCOUNTING
ARTS & CRAFTS
ADULT FITNESS
EMT/PARAMEDIC
COMPUTERS
COLLEGE FOR KIDS
HEALTHCARE CERTIFICATE PROGRAMS

REGISTER ONLINE AT: <http://www.kingsborough.edu/continuinged>
 It's easy! It's fast! It's convenient! For information, call: (718) 368 - 5050

KINGSBOROUGH COMMUNITY COLLEGE
CONTINUING EDUCATION

Kingsborough Community College/CUNY
 Office of Continuing Education
 2001 Oriental Boulevard, Brooklyn, NY 11235
www.kingsborough.edu



New York Community Hospital
invites the community to a
HEALTH FAIR

THIS SUNDAY



Exciting Giveaways & Free Refreshments

Sunday, September 14, 2014
11:00AM-2:00PM

In front of New York Community Hospital
2525 Kings Highway, Brooklyn, NY 11229

- Stroke Awareness
- Nutrition Information
- Blood Pressure Screenings
- Ask the Nurse
- Podiatry Consultations

Ambulance on Site for Children to Tour!

Member
New York-Presbyterian
Healthcare System
affiliate Weill Cornell Medical College

This event has been arranged by Signature Events. For more information, please call 917-327-8261

PORTABELLA

EARLY FALL SUIT SALE

SAVE UP TO **60%** EVERYDAY

INCLUDES THE LATEST DESIGNERS



SLIM FIT SUITS from \$79.99

BUY 1 SUIT
AT THE VALUE PRICE
GET 2 FREE

Or Buy 1 At Our Everyday Low Price

	Value	Everyday	NOW!
New Slim Fit	\$250	\$99 ⁹⁹	3 for \$250
New Vested Suits	\$300	\$129 ⁹⁹	3 for \$300
Luxury Wool	\$425	\$159 ⁹⁹	3 for \$425

BOYS • BIG & TALL • WEDDINGS

SUITS \$59⁹⁹

WHAT'S HOT? BLAZERS, JEANS, SHIRTS

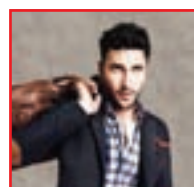

BLAZERS
Velvet Trim
New Designers
DRESS, CASUAL
from \$47⁵⁰



SWEATERS
V-Necks, Crews, Mocks
MODERN FIT
from \$13⁶⁷
3 for \$30



CONTEMPORARY CASUAL SHIRTS
Great with blazers to dress down
from \$19⁹⁹

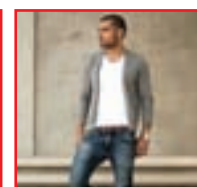

JEANS
Slim Fit, Regular Fit, Boot Cuts
CHOICE OF WASHES
from \$19⁹⁹



THE LARGEST SELECTION IN NEW YORK

SHOES

\$19.99 \$29.99 \$39.99

Driving • Dress • Tuxedo • Fashion
Boys • U.S. Polo • Coogi
Clarks • Florsheim • Kenneth Cole



PORTABELLA

BROOKLYN

503 Nostrand Ave. - Portabella
320 Livingston - Portabella
1671 Pitkin Ave. - Portabella
5205 5th Ave. - Portabella
423 Knickerbocker Ave. - Portabella
294 Utica Ave. - Portabella
1555 Flatbush Ave. - Portabella
851 Flatbush Ave. - Portabella
552 Nostrand Ave. - Fino
469 Fulton St. - Fino
5007 Church Ave. - Fino

QUEENS

163-18 Jamaica Ave. - Portabella
3056 Steinway St. - Portabella
164-08 Jamaica Ave. - Fino
Queens Center - Quails
Green Acres - Quails
174 Main St, Paterson - Portabella
807 Broad St. - Portabella
Livingston Mall - Quails
Woodbridge Center - Quails
5516 Bergenline Ave. - Quails
Freehold Raceway Mall - Quails

BRONX

845 White Plains Road - Portabella
12-20 E. Fordham Rd. - Portabella
2887 3rd Ave. - Portabella
3449 Jerome Ave. - Portabella
2938 3rd Ave. - Fino
345 East Fordham Rd. - Fino
259 E. Fordham Rd. - Britches
645 E. Tremont Ave. - Britches
1498 Parkchester Ave. - Portabella
Bay Plaza Shopping Center - Portabella
13 South 4th Ave., Mount Vernon
MANHATTAN
243 W. 125th St. - Portabella
617 W. 181 St. - Portabella
120 W. 125th St. - Fino
1405 St. Nicholas Ave. - Fino
Manhattan Mall - Portabella

All merchandise not in all stores. All savings off value prices while quantities last. Sale ends Sept. 30th.

Featuring
Brand New
Caribbean
Menu

Let Us Create
The Perfect
Wedding for You
At Affordable
Prices

Glen Terrace
DISTINCTIVE CATERING

Wedding Banquets
And All
Social Functions

718-252-4614 VALET PARKING

5313 Avenue N, Brooklyn
(Between E. 53rd & E. 54th Streets)

Serving
Brooklyn Over
59 Years

South Island Medical Associates, P.C.

FOUNDED IN 1970



...a place for your complete medical care

At South Island, we offer you a healthcare system that doesn't just focus on getting sick people better, but also on preventing people from getting sick. With the help of State-Of-The-Art equipment, our Board Certified physicians & technologists are ready to care for you.

ARE YOU SUFFERING FROM...

- High Blood Pressure
- Heart Conditions
- Diabetes
- Fatigue
- Stomach Ulcer
- Asthma
- Joint Pains
- Sinus Problems
- Weak Bladder
- Constipation
- Hearing Loss

OUR SERVICES INCLUDE:

- Internal Medicine
- Ophthalmology
- Physical Medicine
- Urology
- Physical Therapy
- Cardiology
- Podiatry
- Neurology
- Radiology
- Laboratory
- Gynecology
- Nuclear Stress Testing
- Sonogram
- Geriatrics
- Cardiac Electrophysiology
- Gastroenterology
- Ear-Nose-Throat
- Pain Management

We speak Spanish, Creole, Russian, Hebrew, Yiddish, Hindi, Urdu, French, Chinese & Polish



a name you have trusted for over 40 years

2398 Coney Is. Ave., Brooklyn, NY • (718) 627-1100
8918 Ave. L, Brooklyn, NY • (718) 241-1234
1610 Ralph Ave., Brooklyn, NY • (718) 251-0530

Our other locations:

17-31 Seagirt Blvd.
Far Rockaway, NY
(718) 471-5400

711 Seagirt Blvd.
Far Rockaway, NY
(718) 471-3900

9009 Rkway Bch Blvd.
Rockaway Bch, NY
(718) 318-5400

Some locations may not have all services

24 HOUR EMERGENCY SERVICE AVAILABLE • TRANSPORTATION AVAILABLE FOR SENIOR CITIZENS

MOST INSURANCE PLANS ACCEPTED • WWW.MDSINHA.COM

Jamaican-born designer lights up Grand Central with flashmob show

By Tangerine Clarke

It was fashion in a flash! A “flashmob” fashion show by House of D’Marsh on Friday, Sept. 5, left passersby aghast in Grand Central Terminal, as models sashayed along the corridors in fabulous gowns, and menswear pieces to showcase the magnificent work of Jamaican-born Glenroy D’Marsh.

The Brooklyn-based fashion guru made history when he attracted a large audience to his collection in the busy train station to kick-off New York Fashion Week.

“This is not your typical runway style fashion show or presentation,” he said.

And he was right.

More than 20 svelte models strutted their stuff in the fabulous Spring collection show from D’Marsh’s bold new colorfully-coordinated brand to showcase a yellow mix motif, followed by

black, green, red and white, in topless floor-length gowns, and lavish skirts paired with chic blouses.

The master of fashion outfitted the ladies in dresses with thigh high slits and plunging neckline, some designed with fishtails. The garments were accessorized with lavish bows, belts, jewels, and fringe, in addition to eye-popping, off-the-shoulder and two-piece swimsuits.

The models exuded elegance under the lights that shone on the makeshift runway of the centennial building, and where flashbulbs captured male garments in black, white and yellow ensembles, designed in summer shorts, long sleeve shirts, suits and sweaters, in keeping the brands diverse collection.

D’Marsh stated that upcoming 2015 will be the year of innovation for his



(Above) Glenroy D’Marsh, in yellow, with models in Grand Central Terminal. (Right) One of the latest fashions is modeled — with hashtag! Photos by Tangerine Clarke

brand that has lit up runways across the Caribbean and North America. He added that he would continue to push the boundaries of fashion to ensure the

couture line stays relevant. Follow D’Marsh on Facebook at www.facebook.com/houseofdmarsh, and on Twitter at [#houseofdmarsh](https://twitter.com/houseofdmarsh).

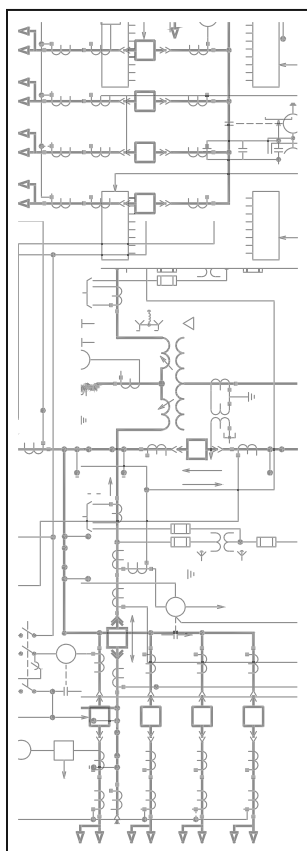

**SOME APPS ARE GREAT FOR KILLING TIME.
THIS ONE'S GREAT FOR SAVING IT.**



To help make your life easier, we've created the My conEdison app for Android™ and iPhone®. Use it to pay your bill, view your billing and payment history, submit a meter reading, and more. It also lets you access our interactive outage map, showing you which areas are affected and providing estimated restoration times. Simply put, it's an app that's worth its weight in kilowatts. And you can download it for free at Apple's App Store™ and the Google Play™ Store. For more information, go to conEd.com/App, or visit us on Facebook or Twitter.



conEdison

EVERYTHING
MATTERS

TRAVELSPAN.COM

TRINIDAD from 193 418 one-way roundtrip	GUYANA from 498 via Panama <small>14 days adv purchase roundtrip</small> 323 662 Non-Stop one-way roundtrip
KINGSTON from 227 463 one-way roundtrip	GRENADA from 337 616 one-way roundtrip

For Further Information Call **718-845-0437** TRAVELSPAN.COM Or Book Online

QUEENS 121-64 Liberty Ave. Richmond 102 NY BROOKLYN 1175 Nostand Ave. Brooklyn NY GUYANA 82 Regent Street Georgetown GT

CHARTER PARTICIPANT AGREEMENT REQUIRED FOR FLIGHTS OPERATED BY WHICH ARE NOT. RATES ARE SUBJECT TO CHANGE WITHOUT NOTICE & SUBJECT TO AVAILABILITY. FALL SEAT SALE!!!! ALL TAXES INCLUDED

CARIBBEAN ROUNDUP

Continued from page 4

held in Guyana in 1994 which was won by the ruling People's Progressive Party/Civic.

The APNU said that when he campaigned as the PP/Civic presidential candidate, Ramoutar had written in the party's manifesto that "in the area of local government and governance, the next PP/Civic government will ensure, within one year of the 2011 general elections, that local government elections are held bringing much needed reinvigoration into local government."

The APNU said three years since the election, Ramoutar "has failed to keep his promise on local government elections."

The opposition grouping has accused the head of state of showing "gross disrespect for the National Assembly by refusing to assent to a bill which was approved after careful scrutiny and arduous work," to pave the way for the poll.

Jamaica

Jamaica says the agricultural sector has lost nearly J\$1 billion as a result of the prolonged drought that has hit the island.

Water, Land, Environment and Climate Change Minister Robert Pickersgill in a joint statement on the effects of the drought on schools and agriculture said that 2,190 hectares of crops valued at \$953.3 million had been lost and that an estimated 18,309 farmers were affected.

"To mitigate the effects of the drought,

the Ministry of Agriculture and Fisheries has disbursed J\$33 million, of which J\$30 million has been allocated to the Rural Agricultural Development Authority, as well as to members of Parliament in the most affected areas, as well as to increase production in those areas," the minister said.

He told legislators that the government is undertaking an audit of the available underutilized greenhouse capacity with a view of working with greenhouse farmers to maximize their production.

Pickersgill said that drought is a result of climate change.

St. Vincent

St. Vincent and the Grenadines Prime Minister Dr. Ralph Gonsalves has defended the new policy of the International Monetary Fund (IMF) to developing countries, even as he acknowledged not being fully satisfied with its lending policies.

Gonsalves called in to the television program "Time to Face the Facts" recently. The program looked at the role of the IMF in the Caribbean.

Gonsalves recalled St. Vincent and the Grenadines had benefitted from a US\$6.4 million loan given by the Washington-based financial institution, "especially in relation to balance of payment difficulties which arose after the December 2013 natural disaster."

— compiled by Azad Ali



Amrish Dias

Senior Loan Officer (NMLS# 65714)

Office: **516.414.6654**

Cell: **516.860.6238**

Fax: **866.219.4347**

Adias@themoneystore.com

THE MONEY STORE®

A Trusted Mortgage Brand For Over 40 Years

For nearly 40 years, The Money Store® name has been synonymous with mortgage lending, leading the way with innovative mortgage solutions. As a Direct Lender, our superior customer service team is dedicated to providing customers with the best rates while offering intelligent and innovative mortgage programs specific to your individual needs.

- First Time Homebuyer
- FHA Loans
- Fixed Rate Mortgages
- Investment Property
- Debt Consolidation
- Refinancing
- Reverse Mortgages
- 203K Loans
- Bankruptcy/Foreclosure Prevention
- VA Loans

Additional Services/Features:

- Cash Out
- 1-4 Family Investment Properties
- 2nd Homes Investment Properties
- Prior Bankruptcies ok (restrictions apply)
- Prior Short Sales ok (restrictions apply)
- Down Payments as Low as 3%
- No Closing Cost Loans
- H.A.R.P. Loans
- Other Jumbo Products to \$2 Million
- Down Payment Assistance Programs in Certain Areas

TheMoneyStoreLender.com



MLD Mortgage Inc. d/b/a The Money Store® 1900 Hempstead Turnpike, Suite 206, East Meadow, NY 11554, 516.227.2500 NMLS# 1019 Licensed by the NJ Department of Banking License# 9917842. Licensed by the NY Banking Department License# B500824. Not all applicants may qualify. Some products may not be available in all states. Program, rates, terms and conditions apply. All rights reserved. Equal Opportunity Lender. See www.themoneystore.com/statelicensing for state licensing information. www.nmlsconsumeraccess.org and www.themoneystore.com/privacy-policy



BROOKLYN BOOK FESTIVAL

Supported by



SUNDAY, SEPTEMBER 21, 2014 • 10AM – 6PM

BOOKEND EVENTS SEPTEMBER 15TH – 22ND

BOOKEND your festival visit by attending special literary events, parties, film screenings, performances and more in bookstores, clubs, theaters and libraries throughout Brooklyn.

ALL FESTIVAL EVENTS FREE
SOME BOOKEND EVENTS CHARGE ADMISSION

2014 AUTHORS AND PARTICIPANTS

Jeffery Renard Allen
Harvey Araton
Paul Auster
Annie Baker
Tanya Batson-Savage
Elif Batuman
Mario Bellatin
Mark Bibbins
Lucie Brock-Broido
Charles Burns
Tina Chang
Roz Chast
Jaime Clarke
Farel Dalrymple
Jules Feiffer
Roxane Gay
Greg Grandin
Lev Grossman
Steve Hindy
Marie Howe

Charlayne Hunter-Gault
Siri Hustvedt
Marlon James
Leslie Jamison
Sandeep Jauhar
Daniel Kehlmann
Chip Kidd
Naomi Klein
K'wan
John Leguizamo
Jonathan Lethem
Leonard Lopate
James McBride
Thurston Moore
Lynn Nottage
Joyce Carol Oates
Pedro Noguera
Philippe Petit
Carl Phillips
Darryl Pinckney

Wendell Pierce
Paul Pope
Retha Powers
Francine Prose
Christian Rudder
Salman Rushdie
Tanya Selvaratnam
Ilyasah Shabazz
Gregory Smithsimon
Barbara J. Taylor
Matthew Thomas
Lynne Tillman
Bob Saget
Eric Schlosser
Zadie Smith
Vivek Tiwary
Rachel Urquhart
Jeff VanderMeer
Edmund White
Tiphonie Yanique

CHILDREN and YOUTH AUTHORS

Patrick Henry Bass
Coe Booth
Ann Brashares
Monica Brown
Nick Bruel
Misty Copeland
Jerry Craft
Brian Flocq
A.G. Ford
Gordon Korman
Christopher Myers
John Parra
Rebecca Stead
R. L. Stine
Jon Scieszka
Scott Westerfeld

AND MANY MORE

*AUTHORS ARE
SUBJECT TO CHANGE

AUTHOR READINGS
BOOKSELLERS
BOOK SIGNINGS
PANEL DISCUSSIONS
CHILDREN'S AREA
YOUTH STOOP
WORKSHOPS

HISTORIC BROOKLYN BOROUGH HALL
BOROUGH HALL PLAZA
AND COLUMBUS PARK
JORALEMON AND COURT STREETS

BROOKLYNBOOKFESTIVAL.ORG

FOLLOW US
@BKBF



LIKE US
ON



PRESENTED BY
BROOKLYN BOOK FESTIVAL INC.
AND
THE BROOKLYN LITERARY COUNCIL

CULTURAL AND PROGRAMMING PARTNERS

BAM
BROOKLYN HISTORICAL SOCIETY
BROOKLYN LAW SCHOOL
BROOKLYN PUBLIC LIBRARY
CAVE CANEM
NATIONAL BOOK FOUNDATION
PEN AMERICAN CENTER
POETRY SOCIETY OF AMERICA
ST. ANN & THE HOLY TRINITY CHURCH
ST. FRANCIS COLLEGE
THE NATION
THE NEW YORK REVIEW OF BOOKS



City of New York
Parks & Recreation



ST. FRANCIS COLLEGE
THE SMALL COLLEGE OF BIG DREAMS



Brooklyn Chamber
of Commerce



conEdison

EVERYTHING
MATTERS



DEPARTMENT OF
NYCULTURE
CITY OF NEW YORK



State of the Arts
NYS Office of Cultural Affairs
NYS CA



WNYC
132.9 MHz
www.wnyc.org



abc
7

The New York Review of Books

THE WALL STREET JOURNAL

Golden Krust celebrates 25 'Golden' years!

Golden Krust

Golden Krust Caribbean Bakery and Grill, the nation's largest and fastest growing Caribbean franchise has been celebrating 25 years in business this year.

The Jamaican family-owned and operated business started back in 1989 in the South Bronx is now a leader in the franchise and baking industry. The celebration began with the company's Mavis and Ephraim Hawthorne Golden Krust Foundation Scholarship Ceremony on Aug. 12. Golden Krust's president and CEO and foundation chairman Lowell Hawthorne was beaming with pride exclaiming that "nothing brings me greater satisfaction than knowing that in some small measure I am sharing in the success of the young scholars being awarded this evening."

Thirteen well-deserving graduating high-school seniors were presented with \$2,000 scholarships toward their college education and 26 students in the United States and Jamaica received scholarships this year.

The company also celebrated this major milestone with system-wide celebrations on Aug. 23, provid-



Left to right: Consul General of Jamaica to NY Honorable Herman Lamon, founder Lauris Campbell, president and CEO Lowell Hawthorne, founder and director of human resources Lorna Hawthorne, Una Clarke, founder Milton Hawthorne, and executive chef Velma Hawthorne at the Golden Krust 25th anniversary celebration.

Golden Krust

ing the first 100 customers with 25-cent beef patties!

The events kicked-off nationwide at noon, and

customers enjoyed live music, free samples, and lots of other giveaways. The main event took place at

the company's first location on 1381 E. Gun Hill Rd. in the Bronx.

Consul General of Jama-

ica to New York Herman LaMont, Una Clarke, and Rev. Dr. Leroy Richards were some of the individuals in

attendance to congratulate the Golden Krust family.

The executive team, staff, family, friends, and customers were out in full force to support and enjoy the unforgettable sounds of the Platinum One Band, the taste of succulent jerk chicken, and a memorable ceremony.

Hawthorne took words from the song "Wind Beneath My Wings," sung eloquently by the soloist Kristina Newland as he saluted his deceased parents for their love, vision, and determination.

The Golden Krust team thanks all their franchisees, staff, and customers for their commitment to the brand.

There are other milestones left to be achieved for the Golden Krust organization. Hawthorne stated that the company looks forward to fulfilling its' 2020 vision of making Jamaican-styled patties and jerk chicken mainstream food items.

Golden Krust Caribbean Bakery & Grill, Inc., www.goldenkrustbakery.com, is a Caribbean food chain. Founded in 1989 by Lowell Hawthorne and his family, Golden Krust headquarters is located in Bronx, NY and has 120 stores nationwide.

SMALL BUSINESS RESOURCES

Small Business Energy | SmallBusinessEnergy.com

www.smallbusinessenergy.com/NewYork
Save on Small Business Energy Bills and Compare Rates. Get a Quote Now!

NYC Small Business Resource Center | The New York Public Library

smallbiz.nypl.org

Small Business Services - Empire State Development New York

www.esd.ny.gov/smallbusiness.html

Small Business - Business First - New York State

www.nyfirst.ny.gov/ResourceCenter/SmallBizMenu.html

2013 New York, NY Small Business Resource

www.sba.gov/sites/default/files/files/resourceguide_3135.pdf

Business Resources: Internet Bibliographies: New York State Library

www.nysl.nysed.gov/reference/busref.htm
Selected business-related web sites compiled by staff at the New York State Library for use in response to reference questions.

Start a Business in New York - Resources for New York Small Businesses

manhattan.about.com/od/careersjobs/a/nysmallbusiness.htm
Find resources and advice on starting a

business in New York City. Get information on New York business licenses and incorporation, free NYC resources for starting a business.

Your Money New York - Help and Resources for Small Businesses

www.yourmoneyny.com/helpresource/smallbusiness/index.php
This section of Your Money New York is designed to help small business owners - and New Yorkers interested in starting a small business.

Small Business Resources - The Business Council of New York

www.bcny.org/inside/smallbusiness.htm
Capital Business Blog - Read about the issues. Visit www.nyfirst.ny.gov to learn what New York State can do for businesses.

Resources for Businesses in New York City - bfindapc.com

www.bfindapc.com/...business-resource.../resources-for-businesses-i
If you operate a business in New York City, you are especially fortunate. The city has pulled together a wealth of resources for small business owners.

Small Business Resource Guide - New York - HUD

www.hud.gov/offices/osdbu/resource/guide/local/newyork.cfm
100+ items - to assist the small business community in the State of New York.

Empire State Development Strategic Business Division Minority and Women's Business Development

New York Regional Office 26 Federal Plaza, Suite 3108. New York, NY 10278

INTERNATIONAL BUSINESS & INVESTMENT

EXPO 2014

EXPO SCHEDULE

Monday September 22, 9am - 9pm

- Expo Seminars & B2B Meetings
- VIP Luncheon Only \$95
- VIP Reception Only \$75

Tuesday September 23, 9am - 2pm

- Investor Sessions
- Networking and Matching Sessions

SEMINARS & MEETINGS ON:

- Finance
- Investments
- Trade Regulations
- Business Process Outsource (ICT)
- Alternative Energy
- Diaspora Funding
- US Government Projects

KEYNOTE SPEAKERS



Fitzgerald Miller
Director of investments
Openheimer & Co.



David Mullings
Serial Entrepreneur.
Managing Partner Real Vibez, Inc
& CEO of Keystone Augusta, Inc



Tilokie Depoo
Dean & Professor of management
School of Business Metropolitan
College of New York

Host



Nicole Beach
Radio Personality



Dahved Levy
DJ WBLS



Emcee
Rose Deonarine

NEW PRODUCT LAUNCH OPPORTUNITIES

- Access to display in product launch pavilion
- Announcements from Microphone
- Promotional material in goodie bags
- Information Displayed Thought the conference



Booth sale
20% off
CALL NOW!

Register today at:
gocaribbeanexpo.eventbrite.com

For more info:
www.gocaribbeanexpo.com
or call (347) 413- 3282

Booth Sales Ends on September 19, 2014

General Attendance - Free
Conference Package - \$225

(Include VIP Luncheon, VIP Reception and 16 Training Sessions)

Restoration Plaza
1368 Fulton Street, Brooklyn, NY 11216



DANCE CLASSES

KIM G. DANCE

**PRAISE DANCE • WEST AFRICAN DANCE
BALLET • MODERN
JAZZ • HIP-HOP**

- Affordable Prices
- Free Costumes
- Sibling discounts
- Two Performances

**KIDS & TEENS DANCE ACADEMY
MENTORING THROUGH DANCE
BOYS & GIRLS AGES 2-12 YEARS OLD**

OPEN HOUSE: September 27 from 11am - 2pm
 ☺ 11:00am - 12:00pm ages 2 - 4 ☺ 12pm - 1pm ages 5 - 7 ☺ 1pm - 2pm ages 8 - 15
Please call to RSVP

LAST DAY TO REGISTER IS SEPTEMBER 27, 2014
Classes are on Saturdays or Tuesdays. Program Starts October 4th

West Minister Bethany Presbyterian Church
Dr. Rev. Agnes Blackmon
644 Macdonough Street
 (Between Howard and Ralph Avenue)
Brooklyn, NY 11233

Call at 347-476-7908
 kimgdance@gmail.com www.kimgdance.com

Suicide rates soar in Guyana this year

By Azad Ali

The World Health Organization (WHO) said Guyana has by far the highest suicide rate among countries in the Caribbean. It is also listed in the top 10 most suicidal countries.

So far for this year more than 30 people have committed suicide, while several others are recovering from failed attempts.

The government says it has developed a "strategic partnership" with the Indian Arrival Committee (IAC) to heighten awareness on the need to prevent suicides in the country.

It said that Health Minister Dr. Bheri Ramsaran met with the IAC who presented their organization's initiative and explored the possibility of a meaningful collaboration.

So far for this year more than 30 people have committed suicide, while several others are recovering from failed attempts.

Ramsaran said there was a need for all stakeholders to be involved in the fight against suicides reiterating the ministry's commitment to work with organizations that have expressed an interest in dealing with social issues.

The IAC in the past had demonstrated its willingness to lead and support an intervention regarding this issue and based on the magnitude of incidents, called for suicide

to be declared a national priority. Further, the organization noted that due to the high rate of suicide, a major international news network visited Guyana and produced a story highlighting this distressing trend.

The IAC believes that much more can be done and had called for meaningful collaboration among the various government ministries "to derive a plan of action which will lead to the provision of education through awareness and related counseling with the aim of reducing and hopefully, eliminating incidents of suicides."

Earlier this year, the government said a multi-sectoral approach was needed to deal with the number of suicides in the country.

Go to www.Caribbeanlifeneews.com for the latest in Caribbean news.



For the past 12 months, we have been servicing the community with dignity and compassion. We look forward to the future providing the same excellent service.



Serving the Community with Dignity

- We have one of the Largest Chapels in the New York City area
- We provide Funeral, Burial and Cremation Services
- We offer great pricing and you can depend on our professionalism
- Valet Parking Available

1922 Utica Ave • Brooklyn, NY 11234
TEL: (718) 444-1818
WWW.CARIBEFUNERAL.COM

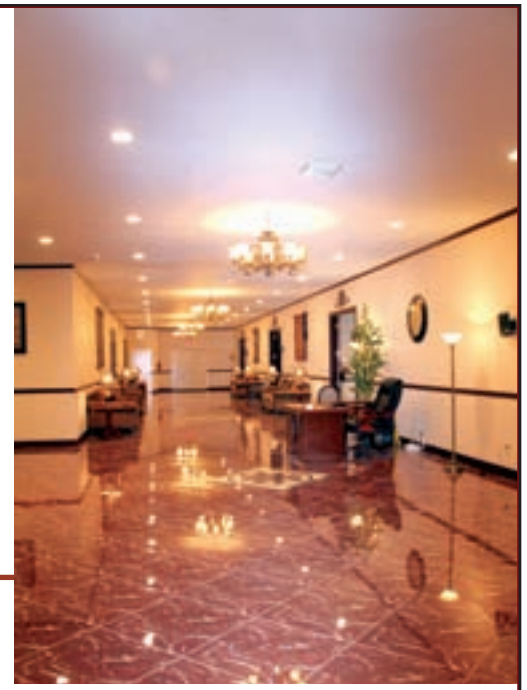

ACCIDENT VICTIMS

AUTO ACCIDENTS • TRIPS AND FALLS • CONSTRUCTION INJURIES

FREE CONSULTATION • No Fee Unless Successful*



**Our Lawyers
Will Come To You!**

**Home, Office or Hospital Visits
Available At No Charge**

**WILLS & REAL ESTATE
PERSONAL INJURY**

Auto Accidents • Truck Accidents

Bus, Train, & Subway Accidents

No-Fault Cases

Spine & Neck Injuries

Slip & Fall • Pedestrian

Defective Products • Lead Poisoning

Schools & Playgrounds • Dog Bites

**WE HAVE OBTAINED
MILLIONS OF DOLLARS
ON BEHALF OF OUR CLIENTS**



**Construction Accidents • Stairways • Ladders
Scaffolds • Elevator/Escalator Injuries • Burns
Improper Security • Machine Accidents • Workers' Comp
MEDICAL MALPRACTICE/NURSING HOME INJURIES
Wrongful Death • Misdiagnosis • Birth Related • Cerebral Palsy**



ARZE & MOLLIKA, LLP

Brooklyn:

2352 80th Street

Brooklyn, NY 11214

718-996-5600

Manhattan:

39 Broadway, Suite 950

New York, NY 10006

646-459-7548

GRAND OPENING Saturday, September 13, 2014

POOR TONY'S

TIRE & AUTO CENTER

A Complete Tire & Repair Center

FREE CAR WASH WITH OIL CHANGE

Buy 3 Tires, 4th one is **FREE**

OIL CHANGE SPECIAL
13 - Point Check

ONLY
\$24⁹⁹

Radiator Flush & Fill

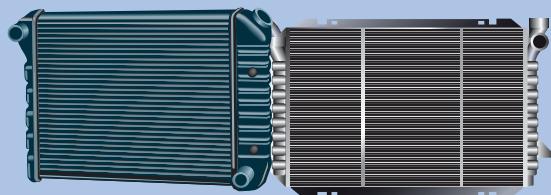

\$39⁹⁵

Computerized Wheel Alignment



\$54⁹⁵

BRAKE SPECIAL
FRONT & REAR

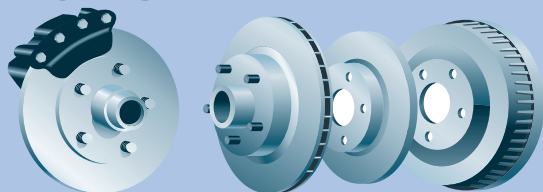

\$59⁹⁵

FREE ESTIMATES



We Stock all Major Brands

Mercedes Benz



\$114⁹⁹

Cadillac Escalade



\$114⁹⁹

Nissan Quest



\$114⁹⁹

Honda CRV



\$99⁷⁵

Ford Taurus



\$84⁹⁹

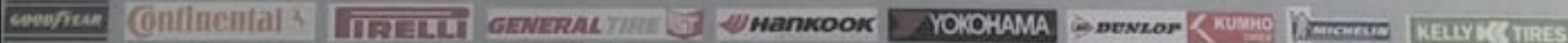

120-01 Sutphin Boulevard | Jamaica, NY 11434 | 718-487-3146

Are You Suffering With Severe Constant Pain?

New Laser Light Breakthrough Treatment May Reduce Or Even Eliminate Pain Of The Worst Kind In Just Minutes

If you are suffering with severe pain despite all the treatments, that may have failed you in the past, you may now have some hope of reducing or even eliminating your pain with a new non-surgical, painless laser treatment now available in Brooklyn.

Deep Tissue Laser Treatment is an innovative, scientifically based, therapeutic modality. This new technology offers advanced pain relief and expedited healing times through a process known as photobiostimulation.

Deep Tissue Laser Treatment delivers, deep, penetrating, photonic (light) energy to bring about profound physiological changes. ATP (Adenosine-triphosphate) production is increased, inflammation and pain reduced and circulation increased at the site of pain. These changes in cellular chemistry are triggered by the deep tissue laser making it a true healing modality.

Deep Tissue Laser Therapy does not require the use of drugs or surgery, and there are no known side effects or risks that may occur with other forms of treatment. In addition, it can often achieve results faster than other treatment modalities. During the treatment the patient will feel a deep soothing warmth. This pleasant sensation reassures the patient that the laser is stimulating cellular activity.

Lasers have made a remarkable contribution toward healthcare, allowing practitioners to treat a variety of conditions with the speed of light. As a non-invasive tool, the laser is particularly effective for the efficient treatment of soft tissue injuries, sprains and strains, and a variety of other ailments and pain.

Low Level Laser enhances metabolic activity at the cellular level, without generating tissue-damaging heat.

Some of the benefits of laser treatment include:

- Fast reduction of pain
- Improvement of nerve function
- Reduction of muscle spasms.
- Speeding of tissue repair
- Development of muscle tissue and collagen
- Reduction of inflammation, swelling and scar tissue formation
- Pain reduction immediately

The Class IV laser, approved by the FDA in 2006, packs a punch while remaining non-invasive. The Class IV laser is capable of reaching depths of 6 to 9 inches, with a treatment beam of up to 3 inches.

Because the Class IV laser reaches deep into the tissues, it is ideal for treating sprains and strains, arthritis, calcified muscles and fibrotic adhesions, as well as intra-articular tissues inside of the joints. Its far-reaching capabilities also allow the Class IV to achieve results in less time than most cold lasers currently used today. With treatment times of as little as 5 to 15 minutes, the Class IV laser allows many conditions to vastly improve within a few visits. Oftentimes, patients find immediate, soothing relief that improves with each treatment.

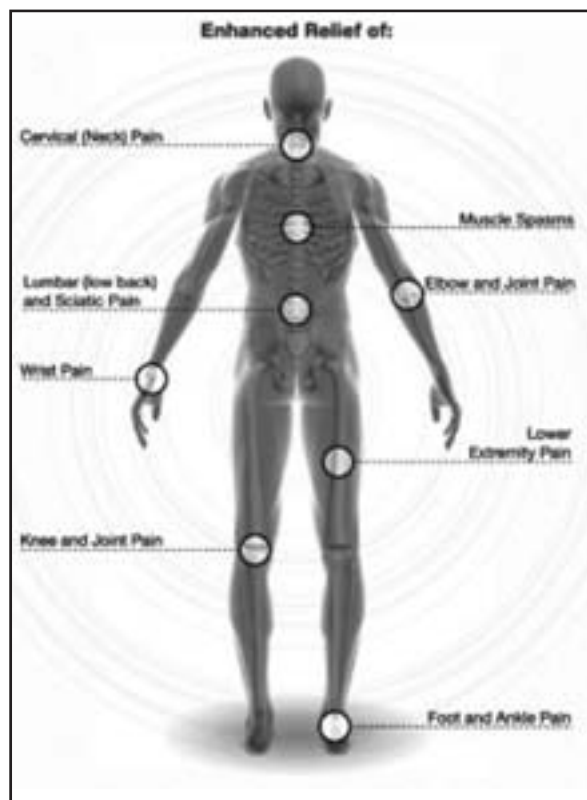

A partial list of the kind of conditions that can be helped...

- Bulging, Slipped Discs
- Spinal Fusion
- Neck Pain
- Sciatica Pain
- Migraine Headaches
- Back Pain & Spinal Conditions
- Tennis Elbow
- Carpal Tunnel Syndrome
- Neuropathy Pain
- Bell's Palsy
- Plantar Fasciitis
- Sports Injuries
- Sprains & Strains
- Knee Pain
- Hamstring Tears
- Arthritic Pain

If you are tired of living with pain and would like to see if you qualify for deep tissue laser treatment call 718-234-6206 for a **FREE CONSULTATION** right now. Dr. Keller has seen such dramatic fast pain relief with Deep Tissue Laser Treatment, that she offers one **FREE** treatment to see if you respond and if you are a candidate for this revolutionary new non surgical pain relieving treatment. Due to the overwhelming response to this type of offer, this offer will be good for the first 25 callers. If the lines are busy, keep trying.

Listen to what patients are saying:

"I had been suffering from knee pain for many months before I tried laser treatments using Deep Tissue Laser. After just a couple treatments, my knee pain was reduced to the point where I can finally live a more normal life again. These treatments are simply remarkable!"

- Jennifer C.

"I started treatments with Deep Tissue Laser after I had injured my neck in a car accident. The treatments allowed me to return to work much more quickly than anyone had expected, considering the pain I was in. During the treatments, all I felt was a warming sensation as the laser was moved across the injured area where all my pain was. After just three short treatments, my pain was almost totally gone. Thanks, Doctor!"

- Jason B.

"The Deep Tissue Laser treatments I received dramatically helped my recovery from a broken leg. Not only did it help reduce the swelling, the pain relief I experienced was nothing short of miraculous. My orthopedic doctor was amazed with the results."

- John M.

Brooklyn Spine Center

Dr. Melinda Keller

5911 16th Avenue

Brooklyn, NY 11204

brooklynspinecenter.com

718.234.6206

Does not apply to federal beneficiaries
Copyright © 2009 Martin

Regulation to curb obesity should be 'stimulated' in the Caribbean



Health advocates say better food choices can lead to slimmer waists.

By Nelson A. King

The Pan American Health Organization has welcomed regulations that seek to inform and protect consumers in the Americas, including the Caribbean, while creating incentives for healthier eating, saying that they are "important advanc-

es that should be stimulated throughout the region."

In addressing and International Conference on Food Labelling and Fiscal Policies on Healthy Food and Obesity Prevention in Quito, Ecuador, over the weekend, the group's Dominican-born director

Dr. Carissa F. Etienne noted that countries in the Americas — which have the highest obesity rates in the world — are fighting the epidemic with "new, stricter regulations on food labelling, promotion, and advertising."

Etienne said that one in two adults in the Americas is overweight or obese, adding that the proportion reaches 75 percent or more in some countries.

And 20-to-30 percent of school-age children and adolescents are overweight or obese.

The organization said growing obesity is one of the major contributors to chronic diseases, such as heart disease, cancer and diabetes, which are now the leading causes of death and illness throughout the region.

"These conditions bring not only suffering and pain but also the spectre of economic bankruptcy for both national economies and family budgets," Etienne said.

The causes of the epidemic include "profound changes in eating patterns in recent decades, with an unprecedented increase in consumption of processed foods and a parallel decrease in consumption of natural products," Etienne said.

She said although the countries of the Americas are "rich and diverse" in healthy, natural foods, the region is increasingly making junk food "the new basic food."

Etienne said Ecuador's Law on Food Security and Sovereignty, which was updated in 2012, is an example of the kind of efforts that are needed to reverse this trend.

The law's provisions protect small farmers' rights to produce healthy foods, guar-

antee consumers' rights to decide what they want to consume, and stimulate the development of fair international trade.

Efforts such as these, aimed at increasing access to affordable healthy foods, "fall within the framework of strategies that both PAHO and [World Health Organization] promote to stop this pandemic," Etienne said.

During the week's conference, Minister of Health of Ecuador Carina Vance presented data from her country's National Survey on Health and Nutrition that show declines in malnutrition, but also significant increases in obesity.

She said Ecuador's response to obesity includes a new system of food labelling based on World Health Organization recommendations, which tells consumers how much sugar, salt, and fat are in processed food products.

Other measures taken by Ecuador include regulations on school meals, an obligatory hour of physical activity during the school day, promotion of breastfeeding, promotion of healthy spaces for physical activity in towns and cities, and stricter regulations on tobacco and alcohol.

"Measures directed only at education and action that is directed only at promoting healthy individual behaviours are necessary, but they are not sufficient," Etienne said.

"The great challenge is to promote public policies that aim to transform the environment, encourage healthy behaviour and inhibit those unhealthy behaviors that are increasing exponentially and that promote harmful and unhealthy patterns of consumption," she added.

LOSE 3-9 INCHES IN 2 WEEKS, NON-INVASIVE!

"What if I told you this cutting-edge device could melt inches off your waist and keep them off for good."

— **Doctor Oz**

talking about the ZERONA® LipoLaser

Introducing ZERONA® LipoLaser — removes fat without surgery, pain or wounds. ZERONA® is a new body-sculpting procedure designed to remove fat and contour the body without invasive surgery. ZERONA® allows you to continue your daily activities without interruptions from surgery, pain or wounds. ZERONA® works by utilizing the Low Level Laser (FDA cleared for laser body contouring to emulsify fat which then releases into the interstitial space. The excess fat is passed through the body during its normal course



of detoxification. The ZERONA® procedure was proven through a double-blind, randomized, multi-site, and placebo controlled study in which patients average loss of 3.64 inches, and some lost as much as 9 inches compared to the placebo group that lost only half an inch.



What you can expect: Our patients lose an average of 8-9 inches from the waist, hips and thighs and reduction in clothes size in **2 weeks**. This is not a quick weight loss program — we are targeting adipose tissue and not taking off excess water weight. Results vary individually.



www.zeronalaserofnewyork.com

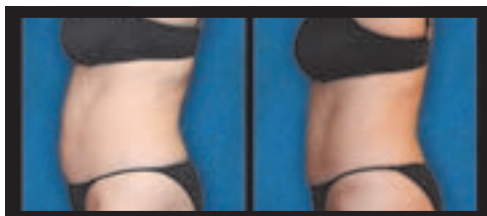

ZERONA® WORKSHOPS

When: Tuesday, Sept. 16, 6:30pm and Tuesday, Sept. 23 6:30 pm

Where: ZERONA® Laser of New York • 5911 16th Avenue, Brooklyn, NY

Cost: FREE (\$79 value) • Call: (718) 234-6212

Go to www.Caribbeanlifenews.com for the latest in Caribbean news, entertainment, sports, business, viewpoints and more.

A LOVE Fellowship CONCERT

TWO GRAMMY AWARD-WINNING COMBINED CHOIRS

**Bishop Hezekiah Walker &
The Love Fellowship Tabernacle Choir**

AND

The Brooklyn Tabernacle Choir



Sunday September 14 at 3:00PM

The BROOKLYN TABERNACLE

www.BrooklynTabernacle.org

17 Smith Street, Brooklyn, NY 11201 | 718.290.2000
Take mass transit to Downtown Brooklyn-Fulton Mall

By Subway 2 3 4 5 to Boro Hall A C F to Jay Street-Boro Hall M R to Lawrence Street-Metro Tech G to Hoyt-Schermerhorn Street
By Bus B25, B26, B37, B38, B41, B45, B52, B54, B57, B61, B65, B67, B75 to Smith and Livingston Street



PROSTATE CENTER

Urgency or difficulty urinating? Painful urination? Erectile dysfunction?



Y. Chalik, MD | L. Hyacinthe, MD | V. Raykhman, MD

- Reliable, Responsive, Top Class Urologists
- Same Day In-office Diagnostic Radiology
- Lab Tests with Immediate Results

We successfully diagnose & treat:

PROSTATE CANCER

Receive Effective Treatment.
Examine Alternatives.

ENLARGED PROSTATE

Reduce Bathroom Trips in 1 week.
Alleviate Other Symptoms.

IMPOTENCE

Regain Firm Erectile Function.
Explore Innovative Options.



America's Top Urologists Since 2009 • Open 7 Days A Week • All Major Insurances Accepted



**BROOKLYN: 2632 E 14th Street, NY 11235
2270 Kimball Street, #101A, NY 11234
QUEENS: 107-15 Jamaica Ave., NY 11418**

718-878-3523

Carib-themed magazine celebrates men's fashion

By Kevin Bollers

It's the Caribbean's answer to GQ!

Caribbean supermodel Corey Baptiste was on hand for a party celebrating the fashion issue of the four-issue old "GCaribbean" magazine, which features the part-Trinidadian, part-Grenadian on the cover.

The invitation-only event on Friday Sept. 5 at the Attic at 251 W. 48th Street in Manhattan featured great music, cocktails, delectable hors d'oeuvres and the chance to meet top-ranked male supermodel.

Created by founder, editor-in-chief, and publisher Geoff K. Cooper got the idea for the magazine at a charitable function three years ago where he saw a young man looking particularly dapper.

"Hey, you look so 'GQ,'" he complemented the man.

The gentleman responded, "Oh no, I'm not gay!"



From left, GCaribbean founder, editor-in-chief and publisher Geoff K. Cooper, Summer issue cover model Corey Baptiste, and vice-president of business development and marketing Fabrice J. Armand.

Photo by Kevin Bollers

Cooper had to explain to him that the term "GQ" doesn't mean gay, it just means you look well groomed and put together.

It was at that moment that he realized that there was a

need for a medium focused on Caribbean men and fashion. Cooper talked about reading mens fashion magazines like GQ, claiming they didn't really speak to Caribbean men — something



GCaribbean is all about.

According to Cooper, GCaribbean has an interesting flavor in terms of the models it picks, the places it shoots and the people it focuses on. Cooper admits

that people call it "GQ Caribbean," but he sees it as a compliment because if GCaribbean can be recognized in the same vein as GQ, the staff must be doing something right.

The significance of a magazine like this is that it allows the Caribbean to be lifted above and beyond the cheeky sand, sea, and rum punch stereotype to a more definite context. According to Cooper, one of the major aims GCaribbean is to present the Caribbean as a place of substance and not just a tourist destination.

Cooper points out that the fourth issue of GCaribbean highlighted the fact that Baptiste is part Trinidadian and Grenadian. He also points out that there are numerous celebrities that have strong and unique connections to the Caribbean and their magazine allows those angles to be explored where ordinarily they would not be in the other fashion magazines of the world.

Cooper's says GCaribbean will naturally evolve into the mainstream while still championing the viability of Caribbean culture. He believes that young men from the Caribbean or of Caribbean descent seeing themselves through the people spotlighted in the magazine champion their own uniqueness.

Torn Earlobes

REPAIRED PAINLESSLY

Also...

- Keloids Removed
- Moles & Skin Growths Removed
- General Ear, Nose & Throat Problems



Stephen Finger, M.D. 718-692-1515
 866-KELOIDS 877-EARLOBE
 (535-6437) (327-5623)

Board Certified Otolaryngology
 Ear, Nose & Throat – Facial Plastic Surgery

2256 Hendrickson Street
 (1 Block from Kings Plaza)

FREE WIFI

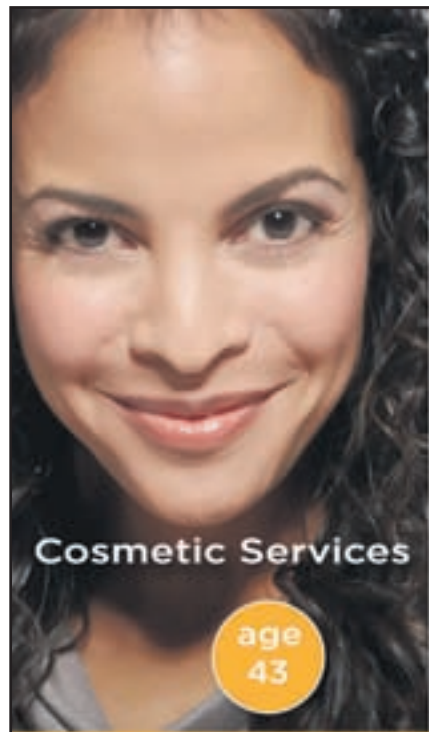

Cosmetic Services

age 43



Botox, Belotero, Juvederm
 Voluma, Radiesse, Sculptra
 Laser Hair Removal
 Laser Vein Removal
 Torn Earlobe Repair
 Keloid Surgery...

age 44

Medical Services we accept:
 GHI, HIP, 1199, AETNA, CIGNA, UNITED, OXFORD,
 HEALTHNET, MEDICARE, BLUE CROSS, MAGNACARE,
 ELDERPLAN, HORIZON and many others

Javier Zelaya MD
 254 Prospect Park West, Bklyn
 136 West 17th Street, NYC

Call Today
 718.832.3313
 skinworksny.com



Lutheran Family Health Centers Caribbean-AmericanSM

We offer a full range of primary care health services for adults and children. Our center is staffed by a team of medical specialists. Languages spoken: English, Creole, Spanish and French.

Our Services include:

- ✓ Behavioral Health
- ✓ Cardiology
- ✓ Dentistry
- ✓ Endocrinology
- ✓ Family Medicine
- ✓ Infectious Disease
- ✓ Neurology
- ✓ Obstetrics/Gynecology
- ✓ Pediatrics
- ✓ Podiatry
- ✓ Surgery

Hours of Operation

Monday and Wednesday: 8 a.m. - 8 p.m. Tuesday: 8 a.m. - 7 p.m.
 Thursday and Friday: 8 a.m. - 6 p.m. Saturday: 8 a.m. - 4 p.m.

Bus: B35 to New York Avenue **2** or **5** train to Church Avenue

Call 718-630-2197 or 718-630-7942 to make an appointment

www.LutheranFamilyHealthCenters.org

April's Dance-N-Feet

Register Now!

Celebrating Our 21st Year

Ages 2 thru Adult

- Boys Classes • Tap • Ballet
- Jazz • Hip Hop • Lyrical • Pointe
- Gymnastics • Praise Dance
- Karate • Caribbean • African
- Adult Classes
- Hip Hop/Caribbean Competition

*Take 2 classes
get the 3rd for 1/2 price!*

We Now Have 4 Great Locations

4626 FLATLANDS AVENUE
 (BET. SCHENECTADY AVE. & E. 46TH ST.)
718-692-4809

9409 & 9411 AVENUE L
 (BET. E. 94TH & 95TH STS.)
718-272-1813

1866 FLATBUSH AVENUE
 (BET. AVE. K & E. 38TH ST.)
718-258-2340

IF YOU HAVE BEEN INJURED IN AN ACCIDENT... DISCRIMINATED AGAINST OR FALSELY ARRESTED

Come see us at the Law Office of
Vincent I. Eke-Nweke, P.C.

WE CAN HELP YOU!!



- **Personal Injury:**
Motor Vehicle Accidents • Slip and Fall • Medical Malpractice • Construction Accidents and More!!
- **Employment Discrimination:**
Sexual Harassment • Hostile Work Environment
Age, Gender, Race & Military Status Discrimination
- **Civil Rights:**
Police Brutality • False Arrest • False Imprisonment

Contact Us At:

498 Atlantic Avenue • 718 852-8300
e-mail: vekenweke@aol.com • www.vekenwekelaw.com

3007 Farragut Rd., Brooklyn, NY 11210 (corner of Nostrand Ave.)

Be Well

Primary Health Care Center, LLC

718-253-WELL (9355) • 718-434-0711

Diagnostic and Treatment Center

NYS Article 28 Facility

MEDICAID, MEDICARE

MEDICAID, HMO's & Most Major Insurance Plans Accepted



**LAB TESTS
SONOGRAMS
EKG'S**

**NO
INSURANCE?
STOP BY
TO FIND OUT
HOW
YOU CAN
GET INSURED
TODAY!**

We Speak Creole, Russian, Philippine & Spanish

ORTHOPEDIC SURGEON

Arthroscopic Surgery • Joint Replacement • Sports Medicine • Hand Surgery • Consultation & Other Services

PAIN MANAGEMENT

Services will include pain management, electromyography, interventional pain procedures including, but not limited to joint injections, epidural steroid injections and nerve blocks, also electromyographic studies for patients with nerve and muscle disease, neck pain, back pain, numbness and tingling in the arms, chronic headaches, joint injuries such as knee and shoulder pain.

DENTISTRY

General Dentistry for Children and Adults • Dentures, Fillings, Root Canals, Crowns & Bridges, Extractions, Bleachings, Cleanings, Check Ups, Gum Treatment

UROLOGY

For Men, Women and Children. We treat the following common urological conditions: prostate cancer, kidney cancer, testicular cancer, urinary incontinence, kidney stones, urinary tract infections, impotence/erectile dysfunction

CARDIOLOGIST | GASTROENTEROLOGY

PHYSICAL THERAPY

Evaluation and Treatment of Acute and Chronic Disorders Including Strokes, Fractures, Tumors, Arthritis • Pain Management Massage, Ultrasound, Electrical Stimulation, Therapeutic Exercises

EAR, NOSE, THROAT

Services include Ear Problem, Throat Problem, Nose Disorders

ENDOCRINOLOGIST

Diabetes • Throid Dysfunction • Weight Control • Metabolism Abnormalities • Osteoporosis

GENERAL VASCULAR SURGEON

Diagnosis & Treatment of Diseases and Tumors of the Skin, Soft Tissue, Breast, Stomach, Pancreas, Bile Ducts, Gallbladder, etc. Diagnoses and Treatment of disease of Veins & Arteries • Breast Biopsy, etc. • Laser Surgery, Vascular Surgery, Laparoscopic Surgery

OB/GYN

- Prenatal Care And Delivery • PAP Smears
- Pregnancy Testing • Family Planning • High Risk Pregnancies Management • Uterine Fibroids And Chonic Pelvic Pain • Menopausal And Menstrual Disorders, Infertility • Pelvic Relaxaation & Urinary Incontinence • HIV & STD Testing And Treatment

NEUROLOGY

- Comprehensive Neurology Exams For Adults
- Alzheimer's And Parkinson's Diseases
- Headaches, Siezures, Chronic Pain, Stroke
- Carpal Tunnel Syndrome • Rehab
- Muscle Testing • Neurological Testing

PODIATRY

- All Foot & Ankle Related Problems
- Blisters And Calluses
- Foot Odor, Ingrown Toenails, Warts, Etc.
- Numerous Treatments & Services For Diabetic Patients

DERMATOLOGY

Full Spectrum Skincare For Adults And Children

- Rash • Acne
- Warts
- Brown Spots
- Sun Damage, Etc.

INTERNIST

- Medical History & Physical Exams
- Wound Care • Cholesterol Screening
- Blood Pressure • Flu Vaccines
- Diabetes, Arthritis, Infections
- Hypertension • Heart Diseases
- Blood, Urine & Stool Testing

PEDIATRICIAN

- Comprehensive Exams Of Children Of All Ages
- Osteopathic Manipulations For Treatment Of Asthma, Headaches, Sinusitis, Otitis, Etc.
- Sick And Well Visits • Immunizations
- All Necessary Forms For Schools, Colleges, Camps & Wic Programs

OPHTHALMOLOGY

- Comprehensive Eye Exams For Adults & Children
- Nearsightedness, Farsightedness
- Astigmatism, Glasses Prescribed
- Evaluation & Treatment Of Eye Diseases
- Glaucoma, Cataracts, Diabetic Retinal Evaluation, Dry Eye

Don't be shy with your doctor about embarrassing gastrointestinal symptoms

Statepoint

The most uncomfortable afflictions are often the most embarrassing. And anorectal health issues can interfere with almost everything one does, from sitting on a bus to enjoying a meal out with friends.

If you suffer from an uncomfortable and at times, painful condition like hemorrhoids, you're not alone. In fact, millions of Americans — particularly those between the ages of 20 and 50 — are affected by hemorrhoids. Additionally, other anorectal disorders can have similar symptoms.

So ditch the embarrassment and use this knowledge to feel empowered to discuss your issue with your doctor. He or she can diagnose the issue properly and offer you tips for relief. In the meantime, here are a few things you can do to address the problem on your own.

- **Change your exercise routine:**

HEALTH

While regular physical activity can improve your cardiovascular health and help you to maintain a healthy weight, certain types of activities can cause hemorrhoids. Straining from weight lifting, for instance, may cause the veins near the anus and rectum to become swollen, eventually leading to this condition. Cycling may also exacerbate the issue. Talk to your doctor about exercises that are safe for you.

- **Don't rush in the bathroom:** Rushing and pushing can cause excessive straining and increase pressure on rectal veins. When you are done, don't linger. Sitting on the toilet longer than necessary can aggravate your discomfort.

- **Lose weight:** Excess weight in your abdomen can increase your chances of developing hemorrhoids.



The first step to relieving gastrointestinal symptoms is to visit your doctor. Statepoint

- **Seek relief:** You don't necessarily need a prescription to relieve the pain, itching and burning associated with hemorrhoids and other anorectal disorders. If your doctor confirms you have

hemorrhoids, look for an over-the-counter topical, local anesthetic at your drugstore, such as RectiCare Anorectal Cream, which contains the highest lidocaine strength available without a prescription. It works quickly to help soothe discomfort. In addition, each tube comes with a supply of "finger cots," little covers that fit over the finger, to promote hygienic application.

Visit www.RectiCare.com for more information.

- **New diet:** If your hemorrhoids are caused by constipation, try adding more fiber to your diet to get to the root of the problem. And remember to drink plenty of water alongside any meal.

Whether you're walking down the drugstore aisle or talking with your doctor, seek the relief you need without embarrassment. Anorectal problems are more common than you think.

+ BROOKLYN MED

THE MEDICAL DIRECTORY FOR BROOKLYN

ALLERGY & ASTHMA

Dr. Gadi Avshalomov, M.D.
The Center for Allergy, Asthma, & Immunology
Board Certified in Adult & Pediatric Allergy & Asthma
2085 E 67th Street, Brooklyn, NY
(718) 444-8014 • www.allergyimmunologydr.com

Dr. Stephen Rand - Kings Plaza Professional Center
Diplomate, American Board of Allergy, Asst. Clinical Professor of Medicine-SUNY Brooklyn. Pulmonary, Nasal & Allergy Testing Treatment
2270 Kimball Street, Marine Park, NY • (718) 377-0011

AUDIOLOGY

Liberty Hearing Centers
Specializing in Revolutionary Invisible Hearing Aid. Free Hearing Screenings
Bay Ridge: 9015 5 Ave.
Sheepshead Bay: 2204 Voorhies Ave.
Flatbush: 445 Lenox Road • 1 (888) 337-5650

CHIROPRACTIC

Live Holistic
Specializing in Spinal Correction & Pain Reduction
Dr. Vincent Adamo, Dr. Rob Ladyzhensky
Most insurance plans accepted
446 Bay Ridge Parkway, Bay Ridge, NY 11209
LiveHolistic.net

DENTISTRY

Dr. Joseph Lichter - Cosmetic & Family Dental
1420 Ave. Brooklyn, NY 11229
www.JosephLichterDDS.com

Dr. Barry Grossman
Mill Basin Cosmetic & Restorative Dentistry Fellow, Int'l Congress of Oral Implantologists
2135 Mill Ave. & 8919 Flatlands Ave., Brooklyn, NY
(718) 531-7700 • www.millbasindentists.com

FAMILY PRACTICE

Camele White, M.D. - Family Physician
Adults, Children and Gynecology/Women's Health Services
385 Remsen Avenue, Brooklyn NY
(347) 915-1755

INTERNAL MEDICINE

Brookdale Medical Associates
Dr. Yitzchak Weinberger - Hematology/Oncology, General Surgery, Internal Medicine, Geriatrics
2701 East 65 Street, Brooklyn, NY 11234
(718) 209-0600

Dr. Martin Slavin, M.D.
Board Certified Internist with specialty in Testosterone Deficiency & Replacement Therapy
5601 Flatlands Ave., Brooklyn, NY
(718) 444-7040 • www.martinslavin.com

Dr. Natalie A. Marks, M.D.
Internal Medicine/Vascular Medicine Specialist Director of the Vein Center of N.Y. Specializing in Varicose Veins.
960-50 Street, Brooklyn, NY 11219
(718) 438-3800 • www.vascularnyc.com

Dr. Zhanna Tsukerman
514 Ocean Parkway, Brooklyn, NY 11218
(718) 484-7040 • www.doctortsukerman.com

South Island Medical Assoc. PC
2398 Coney Island Ave, Brooklyn • (718) 627-1100
8918 Avenue L, Brooklyn • (718) 241-1234
1610 Ralph Avenue, Brooklyn • (718) 251-0530
17-31 Seagirt Blvd, Far Rockaway • (718) 471-5400
711 Seagirt Blvd, Far Rockaway • (718) 471-3900
9009 Rkway Bch Blvd, Rockaway Beach (718) 318-5400

PAIN MANAGEMENT

Dr. Alfredo del Castillo, M.D. - The Pain Center
9731 Fourth Avenue, Brooklyn, NY 11209 • (718) 966-8120

PODIATRY

Santi Podiatry Group
240 East Fifth Street, Brooklyn, NY
(718) 435-1031 • www.SantiPodiatry.com

RHEUMATOLOGY

Dr. Victoria Katz
Internal Medicine. Rheumatology & Pediatric Rheumatology
1664 E 14th St., Suite 401, Brooklyn, NY 11229
71-36 110th St., Suite IJ, Forest Hills, NY 11375
51 East 42nd St., Suite 1808, New York, NY 10017
(718) 375-2300 • (212) 563-6020
www.victoriakatzmd.com

UROLOGY

New York Urology Institute
2270 Kimball Street, Suite 101A, Brooklyn, NY 11234
110-11 72nd Ave., Forest Hills, NY 11375
2632 E 14th St., Brooklyn, NY 11235
(718) 878-3523 • www.nyui.org

VASCULAR

Dr. Enrico Ascher, M.D. - The Vascular Institute of NY
960-50 St., Brooklyn, NY 11219
(718) 438-3800 • www.vascularNYC.com

WEIGHT LOSS

Conquer the Crave®
Physician-supervised weight loss program
507 Chestnut Street, Cedarhurst, NY 11516
(516) 295-7400 or (718) 285-8807
www.conquerthecrave.com

Skin Beauty Laser Center of NY

Dr. James A. DiGiuseppe
Weight loss program. Doctor supervised. YOLO Lipo Laser Procedures
7123 10th Ave., Brooklyn, NY 11228
(718) 835-0704 • www.skinbeautylaser.com

Zerona Laser of NY at Brooklyn Spine Center

Free workshops
5911 16th Ave., Brooklyn, NY 11214
(718) 234-6212

Family Dental Care

"TOP QUALITY CARE AT AFFORDABLE PRICES"

Dr. Irina Yesina DDS
Welcomes Children and Adults



TOOTH WHITENING
FILLINGS (WHITE)
CROWNS
BRIDGES
ROOT CANALS
DENTURES
EXTRACTIONS
CLEANINGS AND MUCH MORE...

CURRENT SPECIALS
Flexible Partial Dentures



Crown (PFM) **ONLY \$400**



OTHER SPECIALS AVAILABLE

711 Nostrand Ave
(Bet. Park Pl & Sterling Pl)
Brooklyn, NY 11216

CALL FOR APPOINTMENT
718.778.7600

Medicaid, Locals and Most Insurances Accepted!!!

Independents seek to revoke bill

The opposition Independent Liberal Party (ILP) in Trinidad and Tobago is taking the government to court over the controversial Constitution Amendment Bill which was passed recently in the Senate.

The ILP last week filed a constitutional motion in the High Court, Port of Spain arguing that the bill breaches constitution rights, as detailed in the affidavits also filed by two citizens, Sherwin Mitchell

and Dane Francois, both ILP members.

Mitchell is contending that the bill breaches his constitutional right as an elector, while Francois has alleged that the bill violates his rights as a potential general candidate.

Attorney Rekha Ramjit, who is representing the ILP, said Section 4 of the Constitution states, rights including freedom of political expression, while Section 5 says no law must infringe

those rights, even as section 13 says any infringement can only be done with a three-fifths special majority.

She said even as section 73 of the Constitution says you elect a Lower House by first past-the-post system, the bill amends this to read a runoff.

She warned that this new voting system could create an inequality of treatment in violation of the constitutional norms.

Embattled registrar to stay in St. Vincent

The Immigration Department has prevented the embattled former registrar of the High Court in St. Vincent, Vanessa Tamara Gibson-Marks, from leaving the island for her homeland, less than 24 hours after she was granted bail on theft, abuse of office and falsification charges.

"The information received is that there is an ongoing investigation in which

Marks was needed and she was stopped," said Chief Immigration Officer Stanford Hamilton.

Marks was granted EC\$30,000 bail when she appeared at the Kingstown Magistrate's Court recently. The court did not ask her to surrender her travel documents,

Marks checked in to travel on a one-way ticket to St. Lucia recently, but she

was unchecked and her bags removed.

She pleaded not guilty to the charges and is scheduled to re-appear at the Kingstown Magistrates Court on Oct. 7, 2014.

Marks is also expected in court later this month to give cause why she should not be disbarred from practicing law in St. Vincent and the Grenadines.

IMMIGRATION VICTORY

GREEN CARD AFTER A GRILLING MARRIAGE INTERVIEW.

"My husband filed for me after our marriage. The Immigration officer scheduled us for a second interview. We were both worried. Ms. Onuoha handled the process and filed all necessary papers. She appeared at the interview with us. The interview lasted several hours as me and my husband were interviewed separately. We received great support and excellent legal services from Ms. Onuoha. The interview went well because she made sure we were well prepared and all paperwork was intact. I received my Green Card after the interview. Roseline. New York



- PRACTICED LAW FOR OVER SEVENTEEN YEARS.
- ADMITTED TO PRACTICE LAW IN THE STATE OF NEW YORK
- MASTER OF LAWS (LL.M) DEGREE FROM BENJAMIN CARDOZO SCHOOL OF LAW, NEW YORK.
- MEMBER OF THE AMERICAN IMMIGRATION LAWYERS

I CAN WIN YOUR IMMIGRATION CASE!!!

CALL NOW FOR FREE CONSULTATION!!!

(PHONE) 212-971-9704

(CELL) 732-642-5605

575 LEXINGTON AVENUE, 4TH FLOOR,

NEW YORK, NEW YORK 10022

TRAINS: E M 6 TO LEXINGTON & 53RD AVE.

Florida Land Deals

When you think of a secure future think Florida.
Florida Real Estate is one of the hottest in the nation.

- Escape winter
- Build an affordable home of your dreams
- Invest in your future



With just
\$2,000 Down
Payment and
only **\$7.00 per**
day

Thru this Special Home-site Program this house could be yours.

NO credit check for Home-site

NO pre-qualification

\$199 to fly and check it out

Included Airfare Hotel accommodation and meals (limited Time)

Contact Owen: 1-917-751-1792 for more information

HOLIDAY SEASON SPECIAL

Contractor's discounts

DOORS, KITCHENS

TOP QUALITY AT CLOSEOUT PRICES



MORE, inc.

7305 New Utrecht Ave, Brooklyn, NY 11204 • Phone: 718-513-9000 • Fax: 718-513-9001 • Email: doorskitchensandmore@yahoo.com
 Store Hours: Mon., Tue., Wed., Fri. and Sat. 9AM-6PM, Thurs. 9AM-8PM



UP TO 56% off
 suggested retail price on our kitchen stock

SPECIAL PURCHASE: OAK ISLAND AND COLONIAL MAPLE
 9"-36" WIDE, WALL OR BASE KITCHEN CABINETS
 ALL WOOD CONSTRUCTION, FULLY ASSEMBLED **\$99.95**

KITCHEN CABINETS, FLOORING, BATH VANITIES, FAUCETS, EXTERIOR AND INTERIOR DOORS, LOCKS AND MUCH MORE
FREE KITCHEN LAYOUT AND DESIGN WITH PURCHASE

LARGE SELECTION OF VANITIES
 Many other styles available



Cherry or White with marble top
 24"X21"

\$399.00



Concord Cherry starting at

\$179.00

24"X21", (was \$199.00)
 top not included

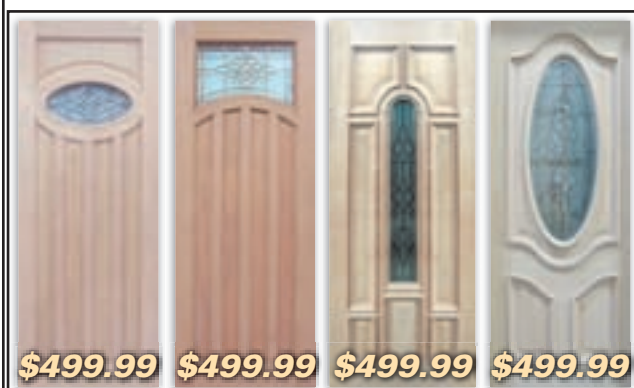

\$499.99 \$499.99 \$499.99 \$499.99

OAK EXTERIOR DOORS (as shown)
 Large selection of other styles



oak, any size **\$159.99** primed starting at **\$39.99** pine, starting at **\$69.99** pine, starting at **\$89.99**

INTERIOR DOORS (as shown)
15% off any lock with any door purchase

15% off any faucet with any vanity purchase

Whether you're buying or selling a car, If You Can't Make It To Us, We'll Pick You Up. Call **877-356-5030** For Complimentary Pick Up

ALWAYS MORE OF WHAT YOU'RE LOOKING FOR!

ALL MAKES. ALL MODELS. ALWAYS AFFORDABLE

PURCHASE A VEHICLE BETWEEN 9AM-5PM FROM NOW UNTIL MONDAY AND RECEIVE A GIFT ON US OF EITHER AN IPOD, NAVIGATION, CAR ENTERTAINMENT SYSTEM or BLUETOOTH KIT... COMPLIMENTS OF MAJOR WORLD!^^

PURCHASE A VEHICLE BETWEEN 9AM-5PM FROM NOW UNTIL MONDAY AND RECEIVE A GIFT ON US OF EITHER AN IPOD, NAVIGATION, CAR ENTERTAINMENT SYSTEM or BLUETOOTH KIT... COMPLIMENTS OF MAJOR WORLD!^^

CARS STARTING AS LOW AS \$2,995!

YEAR	MAKE/MODEL/MILES	STK /VIN	PRICE	YEAR	MAKE/MODEL/MILES	STK /VIN	PRICE	YEAR	MAKE/MODEL/MILES	STK /VIN	PRICE
2001	Honda Civic, 81k	73406	\$2,995	2010	Honda Fit, 17k	1037	\$6,395	2012	Nissan Altima, 32k	1079	\$11,500
2000	Honda Civic, 136k	83850	\$2,995	2010	Toyota Camry, 34k	1013	\$8,995	2012	Chevy Traverse, 50k	1260	\$12,888
2003	Honda Accord, 91k	72885	\$3,995	2011	Honda Civic LX, 47k	7569	\$8,995	2009	Honda Pilot, 36k	1032	\$13,995
2004	Lexus IS 300, 84k	40087448	\$4,995	2011	Nissan Altima, 10k	1026	\$9,995	2012	Nissan Murano, 12k	5822	\$16,995
			MANY MORE LIKE THIS TO CHOOSE FROM!				MANY MORE LIKE THIS TO CHOOSE FROM!				MANY MORE LIKE THIS TO CHOOSE FROM!

MANAGER SPECIALS

YEAR	MAKE/MODEL/MILES	STOCK /VIN	PRICE	YEAR	MAKE/MODEL/MILES	STOCK /VIN	PRICE
2011	Honda Accord, 31k	2651	\$9,995	2008	BMW 528xi, 34k	1008	\$13,995
2011	Nissan Rogue, 32k	4761	\$10,995	2009	Infiniti G37x, 52k	1255	\$14,888
2013	Dodge Grand Caravan, 43k	3793	\$12,995	2012	Dodge Charger, 8k	1030	\$15,995
2012	Honda Accord, 32k	1223	\$12,995	2012	Jeep Grand Cherokee, 19k	1934	\$16,900
2013	Chevy Malibu, 3k	1382	\$13,995	2011	Ford Edge, 51k	1241	\$16,995
2011	Honda Odyssey, 35k	4830	\$13,995	2012	Nissan Maxima, 20k	3788	\$18,995
2014	Nissan Versa, 9k	3309	\$13,995	2012	Infiniti G37x, 9k	7774	\$19,595

CLIP IT. BRING IT. CASH IN!

UP TO **\$3,000**

- TOWARD THE PURCHASE OF ANY VEHICLE
- ADDITIONAL VALUE FOR YOUR TRADE • DOWN PAYMENT*

Authorized Signature Required, General Manager

Must be presented prior to negotiations. Cannot be used for service or parts. Cannot be combined with other offers.

Don't Make Your Next Payment Until You Speak To Us!

MAJORWORLD.COM

1-877-625-6766 43-40 NORTHERN BLVD. LONG ISLAND CITY, QUEENS, NY 11101

TIRED OF YOUR CAR? WE'LL BUY IT FROM YOU!*

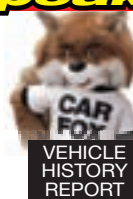

'13 HYUNDAI ELANTRA

\$8,995

Auto, 4 cyl, A/C, p/opts, 28k miles, Stk#3640 PLUS TAX & TAGS



'12 HONDA CIVIC

\$10,995

Auto, 4 cyl, A/C, p/s, p/b, 31k miles, Stk#5650 PLUS TAX & TAGS



'12 TOYOTA CAMRY

\$10,995

Auto, 4 cyl, A/C, p/s, p/b, 21k miles, Stk#1404 PLUS TAX & TAGS



'11 TOYOTA SIENNA

\$13,995

Auto, 6 cyl, A/C, p/s, p/b, 15k miles, Stk#1034 PLUS TAX & TAGS



'13 NISSAN ROGUE

\$15,995

Auto, 4 cyl, A/C, p/s, p/b, 11k miles, Stk#7453 PLUS TAX & TAGS



'14 CHEVY CAMARO

\$16,995

Auto, 6 cyl, A/C, p/s, p/b, 15k miles, Stk#6879 PLUS TAX & TAGS



2011 TOYOTA RAV4

BUY FOR: **\$9,995** PLUS TAX & TAGS

Stk# 1066, 48k mi.

2011 HONDA CRV

BUY FOR: **\$13,995** PLUS TAX & TAGS

Stk# 4923, 24k mi.

2013 TOYOTA COROLLA



BUY FOR: **\$103**

PER MO./ 72 MOS @ 1.99% APR W/ \$2995 DOWN PLUS TAX & TAGS Stk# 2595, 19k mi.

2014 HONDA ACCORD



BUY FOR: **\$139**

PER MO./ 72 MOS @ 1.99% APR W/ \$2995 DOWN PLUS TAX & TAGS Stk# 8569, 11k mi.

2012 FORD ESCAPE



BUY FOR: **\$10,995**

PLUS TAX & TAGS Stk# 7278, 72k mi.

2011 HONDA PILOT LX



BUY FOR: **\$14,995**

PLUS TAX & TAGS Stk# 5210, 23k mi.

2013 ACURA TL



BUY FOR: **\$17,995**

PLUS TAX & TAGS Stk# 7918, 18k mi.

2011 MERCEDES C300



BUY FOR: **\$18,995**

PLUS TAX & TAGS Stk# 3824, 14k mi.

2011 ACURA MDX



BUY FOR: **\$21,995**

PLUS TAX & TAGS Stk#1321, 48k mi.

2011 MERCEDES ML-350



BUY FOR: **\$22,888**

PLUS TAX & TAGS Stk# 5589, 25k mi.

2014 FORD EXPLORER



BUY FOR: **\$22,995**

PLUS TAX & TAGS Stk# 8588, 4k mi.

2013 NISSAN ALTIMA



BUY FOR: **\$13,995** PLUS TAX & TAGS

Stk# 1226, 20k mi.

2013 BMW 328i xdrive



BUY FOR: **\$25,995** PLUS TAX & TAGS

Stk# 3881, 18k mi.

1% IS ALL YOU PAY TO DRIVE/AWAY! WE ARE SURE TO HAVE A CAR TO FIT YOUR BUDGET!

EASY FINANCING! OVER 30 BANKS ON LOCATION! EASY FINANCING! NO CREDIT! NO PROBLEM!

Prices include all costs to be paid by the consumer except for license, registration & taxes. Used vehicles have normal wear, tear & mileage, some may have scratches & dents. ††All applications will be accepted. Severity of credit situation may affect down payment, APR & terms. Bankruptcies and liens must be discharged. *Voucher available on vehicle purchase of \$10,000 or more. **Vehicle must be in safe operating condition, dealer not responsible for excess wear and tear. ^Slight h2o damage. ^^Available with purchase, while supplies last. Some exclusions may apply, see dealer for details. Offers cannot be combined. NYC DCA#200342, DMV#711789.

Parochial schools offer more than just religious training

By Tammy Scileppi

In these turbulent times, young people need direction, something to believe in.

More than ever before, a quality education is crucial to students' achievements in the 21st century. It is not only about keeping up with technological advances, but even more about becoming an well-around individual and living a purposeful life.

Learning important academic and life skills is the key to achieving personal success in a complex world and future career goals in a super-competitive, precarious job market.

When it comes to education in Queens' and Brooklyn's Catholic schools and academies, it is all about focusing on developing the whole child — mind, body and spirit.



Our Lady of Lourdes celebrated Catholic Schools Week with an International Festival and performance during Sunday Mass last year. Photo by Christina Santucci

This holistic, values-based approach — rooted in the mission of the Catholic Church and fully integrated into all programs — makes for a unique learning experi-

ence. This is what sets Catholic schools apart from other local, non-sectarian private schools.

Finally, there is the relationship between parents,

their parishes and dedicated teachers and administrators, which ensures a quality education.

Offering the resources for personal enrichment in

intellectual, social, spiritual, cultural and athletic pursuits, Bishop Kearney High School in Brooklyn, a college preparatory school for young women, is known for its tradition of excellence.

"We endeavor to educate a new generation of women leaders capable of shaping the future with vision, charity, understanding and concern for all humanity in a safe and moral environment," said admissions director Rachel Kasold.

Kearney's academic program offers a full range of Advanced Placement, honors and Regents courses. With a student faculty ratio of 17:1, resource centers in every department, and more than 40 student clubs and activities, including nine sports, each student is provided the best opportunity to excel, said Kasold.

Every member of the class of 2014 attends college and 77 percent of them received almost \$20 million in academic scholarships and performed almost 20,000 hours of community service.

Reflecting the state Learning Standards in a safe, caring and supportive environment, the Catholic

academies and schools within the Diocese of Brooklyn educate more than 30,000 students in Brooklyn and Queens, according to Brooklyn Diocese press secretary Stefanie Gutierrez.

From early childhood through high school, students are provided with a challenging curriculum that eventually preps them for college and beyond: math, English language arts, social studies, science, physical education, music, the arts and languages other than English.

"Central to the curriculum is the use of 21st-century technology within the classroom setting, allowing students to develop skills that will prepare them for college and careers in the 21st century," said diocese Superintendent Thomas Chadzutko.

A beautiful landmark church in Forest Hills, Our Lady Queen of Martyrs has been serving the community since 1928. Principal Anne Zuschlag said enrollment continues to grow each academic year. For 2014, more than 360 nursery through eighth-grade students were welcomed.

Turn your power on at Live Holistic



Chiropractic & Holistic Care For Greater Health, Mobility, & Pain Relief

5 Essentials to Health • Nerve Supply • Exercise • Detox Time & Stress Management

Maximize Your Mind • Lean Muscle • Spinal Correction • Percussion Massage
Whole Body Vibration - Boosts • Bone Density • Loosens Lower Back & Reduces Leg Pain

Full Examination w/ X-rays - only \$45.00
Regularly \$350.00

MOST INSURANCES ACCEPTED

Not Insured? We Offer Affordable Payment Plans

Dr. Vincent Adamo
718-921-5483

446 Bay Ridge Parkway, Brooklyn, NY 11209

www.liveholistic.net

CHIROPRACTIC CARE FOR HIGH SCHOOL ATHLETES & CHILDREN
We Carry Homeopathics & Natural Vitamins

Your Trusted Parenting Magazine!



Get Your Copy Today!

At your local library or other specialized locations throughout Queens, Brooklyn and the Bronx.

Check us out at
www.NYParenting.com

For distribution information, please call us at (718) 260-4554

Prepare for College and Beyond CATHOLIC HIGH SCHOOL FAIR

Benefits of a Catholic High School Education:

- 100% graduation rates
- Nearly 100% college attendance
- Millions of dollars in scholarships
- Average class size of 24
- Recent graduating classes have earned approx. \$175,000,000 in college scholarships
- Over 17,000 students total
- Experiences and friends for a lifetime



St. Francis College

Mon, September 22nd | 6 PM - 8 PM

GENOVESI CENTER, 4th Floor

180 Remsen Street

Brooklyn, NY 11201

(Between Court & Clinton Streets)

St. John's University

Wed, September 24th | 6 PM - 8 PM

TAFFNER FIELD HOUSE

(Next to Carnesecca Arena)

8000 Utopia Parkway

Queens, NY 11439

(Between Union Turnpike
& Grand Central Parkway)

Bishop Kearny High School · Bishop Loughlin Memorial High School · Cristo Rey Brooklyn · Fontbonne Hall Academy · Nazareth Regional High School · St. Joseph High School · St. Edmund Preparatory High School · St. Saviour High School · Archbishop Molloy High School · Xaverian High School · Cathedral Preparatory School and Seminary · Christ the King High School · Holy Cross High School · The Mary Louis Academy · Monsignor McClancy Memorial High School · St. Agnes Academic High School · St. Francis Preparatory High School · St. John's Preparatory High School

'Satisfy My Bowl' a creamy tribute to Bob Marley

In addition to "Chunky Monkey," "Cherry Garcia," "Hazed & Confused," "Liz Lemon," "Mango Mango," and "White Russian" Ben & Jerry's now adds "Satisfy My Bowl" to their flavorful assortment of desserts.

Named to parody Bob Marley's hit song "Satisfy My Soul," the ice cream treat adds to the long list of specially named flavors marketed by a company acclaimed for being a "socially conscious ice-cream maker."

Due in stores on Sept. 15, the Marley treat was named to "pay tribute to a man who dedicated his life to bringing people together through music" and will mark the 30th anniversary of the release of the legendary track which was compiled on Marley's best-selling "Legend" album.

"We're celebrating our father's legacy of bringing people together and using music to drive social change through a sweet partnership with Ben & Jerry's," Marley's eldest daughter Cedella



Inside Life

By Vinette K. Pryce

reportedly said.

First released on the "Kaya" album in 1978, the song debuted simultaneously with the launch of the ice cream company by two former hippies in Burlington, Vermont.

It was 1978 and the concept of healthy eating, conscious music, and clever marketing coincided. In England and Jamaica, Marley's message and music exploded.

Ben & Jerry's is reputed for advocating for some worthy causes. The company is acclaimed for supporting Farm Aid to independent farmers; increasing voter turnout among young people by partnering with Rock the Vote to offer Free Cone Day and registering more than 11,000 voters — the biggest one-day grass

roots registration in Rock the Vote's history.

When the U.S. Food and Drug Administration declared that it believed meat and milk from cloned animals was safe to eat, Ben and Jerry's defied the decision by urging Americans to speak out against cloning. They sent a herd of cow-costumed individuals to Washington, D.C. for a protest "Truth or Clone-sequences" demonstration.

They were also prominent in the Occupy Wall Street campaign which rallied against increasing economic inequality in the United States, high unemployment, mortgage fraud, and corporate influence in American politics. Its board of directors issued a statement of solidarity and showed up in Zucotti Park on sever-

al occasions to scoop ice cream for Occupiers. As the campaign to label food products made with genetically modified organisms moved across the states, the company also stood with a growing consumer movement that advocated for transparency and "genetically modified" labeling legislation. The company boasts that all of their ingredients are fully non-GMO.

The new Marley venture adds to a long list of commercial projects associated with the Marley brand which includes a restaurant, coffee, children's books, and a musical. There have also been a shoe line, water, and a number of concert series.

In a recent article in Speakeasy Magazine, the singer and entrepreneur who also launched her "Catch A Fire" clothing line — named in honor of her famous father's recording — responded to a question about the perception of over-commercialization of the brand saying: "It's a fine

line because I don't think lots of people know daddy was a very smart businessman. He started his own record label, built his own (recording) studio."

She added that her iconic father also "started his own distribution company where he was pressing records."

"We have to remember daddy was in the music business and it's a business. At the same time, we keep the integrity of the man separate from the integrity of the musician," she explained.

"He was very strict when it came to his business. He was the first person to print a Bob Marley T-shirt, let's not get it twisted! He would wear his own T-shirt because that is the music business."

Agreed through a partnership with the family's One Love Foundation, the ice cream company will donate proceeds from the special-edition flavor to promote peace, love, and social equality on the island of Jamaica by energizing the

creative skills of youths.

Ben & Jerry's ice cream tribute to the king of reggae is a blend of caramel and cookie swirls with bananas topped off with "a chorus of chocolatey peace signs."

But don't rush to outlets to purchase the sweet treat. Unfortunately, sales are limited to the United Kingdom, the Netherlands, Ireland, Denmark, Finland, Sweden, and Norway.

A petition is being encouraged to urge Ben & Jerry's to make the flavor available to American ice cream buyers.

"I think we can all agree that this is a big mistake, and so we need to take action," an ice cream lover wrote at www.ipetitions.com

The blogger said "I am going to try to convince them (B&Js) to make it a global flavor."

A number of individuals have also voiced the need for the Marley signature flavor to be made available for retail in the United States.

Catch you on the inside!

Your chance to win a
Cadillac CTS™ or **\$50,000 Cash!**
Mondays & Thursdays in September



 *Pure Cadillac*



EMPIRE CITY.
CASINO



Baccarat, Craps and Roulette are video lottery games operated by the New York Lottery. Must be 18 years of age or older to play New York Lottery games or wager on horses. Please play responsibly. If you or someone you know has a gambling problem, help is available. Call the 24-hour toll-free help line at 1-877-5HOPENY. Visit a promotions booth for complete rules and details.

ENTERTAINMENT

FOR MORE ENTERTAINMENT, GO TO CARIBBEANLIFE.COM

'Rising Star finalist' Lisa Punch in B'klyn

By Tangerine Clarke

Lisa Punch proved that she is a talented to be reckoned when she brought her vivacious performance to the stage of the recent Guyana Folk Festival.

The Georgetown girl was a finalist on ABC's "Rising Star," where she garnered 80 percent of the East Coast votes and 78 percent from the West, to raise the wall, and received positive comments from music's heavy weights, Ke\$ha, Ludacris and Brad Paisley.

"It was an overwhelming feeling for me. I was nervous, but excited at the same time," stated the former Guyana deejay during an exclusive backstage interview at the cultural event in Brooklyn.

Punch praised her mentor and vocal coach Dorian Holly for the great advice he gave her.

"He inspired me by saying this is what you have been



"Rising Star" finalist Lisa Punch on state in Brooklyn. Photo by Tangerine Clarke

doing all of your life, this is all you know to do, imagine you are singing for the people who love to hear your voice."

These words of encouragement fueled the passion Punch has for music, she said.

"I went on stage with Guyana in mind and I transformed my thoughts to back
Continued on Page 40

Arts group brings film, shows to Flatbush

By Kevin Bollers

"Be bold. Be beautiful. Be CaribBeing" is the motto for CaribBeing, an organization committed to the uplifting and empowerment of Caribbean culture and heritage through film and art. CaribBeing aims live up to its slogan by bringing the freshest Caribbean-based events to Brooklyn, particularly in the Flatbush community.

CaribBeing's most recent event took place on Saturday Sept. 6, 2014 at the Reformed Protestant Dutch Church of Flatbush on the



Jouvert visual artists Pagwah perform on the streets of Flatbush and Church avenues.

Photo by Kevin Bollers

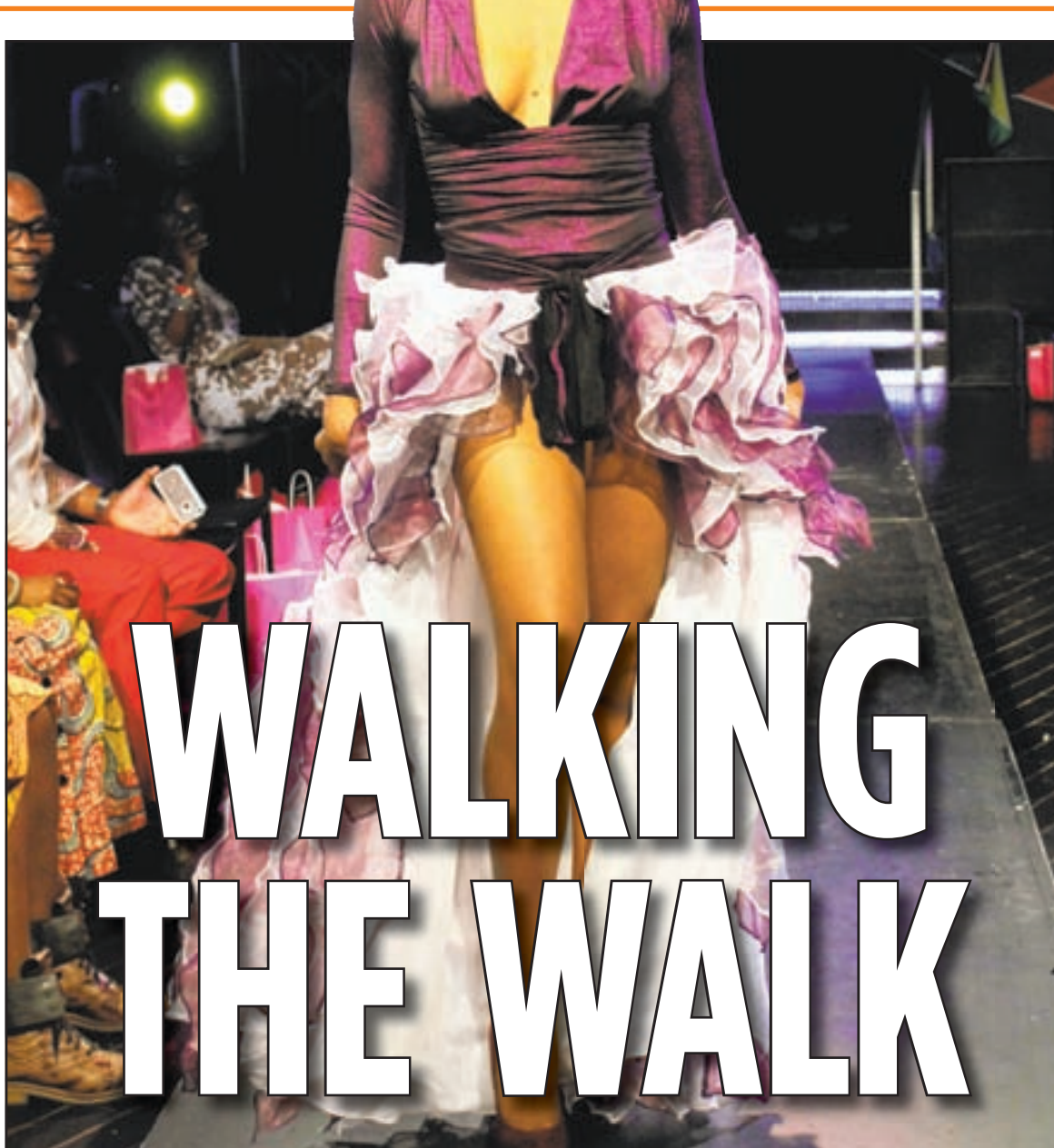

WALKING THE WALK

Model Ayana L. Whitehead wearing gown designed by Carol Fraser of Guyana.

Photo by Kevin Bollers

Carib Fashion Week hits Midtown

By Kevin Bollers

The hippest and coolest fashion from the most cutting-edge designers that the Caribbean has to offer were on display during the Caribbean New York Fashion Week 2014 that hit midtown on Sept. 7.

Twelve designers from nine Caribbean Islands including Antigua and Barbuda's Daniel Shem Henri; Barbados' Andrew Harris Jr.; Domi-

nica's Glenda Jones; Guyana's Carol Fraser, Myrna Patterson, Patricia Jonas, and Sonia Noel; Haiti's Prajje Jean-Baptiste; Jamaica's Gillian Francis aka Minka; Saint Lucia's Lisa Barton-Volney; Trinidad and Tobago's Athaliah Samuel; the Bahamas' Apryl Burrows. Participating Caribbean Featured Models included: Dominica's Barbie "Alias" Labassiere and Ruth Augustine;

Grenada's Aria M. Francis; Guyana's Nkechi Vaughn; Jamaica's Face Of Fashion "Jamaica" 2013 first runner up Venissa Bruce and second runner up Shamecia Ritchie; Trinidad and Tobago's Miss World 2012 Athaliah Samuel and Soowan Bramble; the Bahamas' Chantiyah Miller, Ray-Ann Smith and Rokara Hepburn.

Caribbean New York Fashion
Continued on Page 40



2014

Caribbean Life

DIASPORA
DASHBOARD.com
Where the Caribbean and its Diaspora Meet™

40 under 40 AWARDS

CALL FOR NOMINATIONS

At a gala this November Caribbean Life and DiasporaDashboard.com will present the 40 Under 40 awards to the next generation of Caribbean American leaders. These individuals will represent the best of the Caribbean diaspora working in a diversity of fields: from finance, education, and non-profit to manufacturing, media, and retail and everything in between.

We will honor West Indians who, through perseverance and hard work, have realized the American dream and who have brought a sense of Caribbean pride along with them.

If you would like to nominate a Caribbean American, under the age of 40, who has shown outstanding achievements in his or her field, and who resides or works in New York, New Jersey or Connecticut, please fill out the form here and fax or mail to us before **September 26, 2014**. You can also submit your nomination online at CaribbeanLifeNews.com/nominate.

We will contact you before **October 3, 2014** if your candidate is selected.

Nominate an Outstanding Caribbean American 40 Under 40 Professional

Your name: (Please print clearly) _____

Name of nominee: _____

Nominee or nominee's parents' West Indian country of origin: _____

Your relationship to nominee: _____

Nominee's occupation/profession: _____

Where does your nominee currently work? _____

What will be your nominee's age on November 20, 2014? _____

Previous awards or professional recognition (if any): _____

What makes your nominee outstanding? (100 words or less): _____

How can we reach you?

Daytime phone _____ Cell phone _____ Home phone _____ Email _____

How can we reach your nominee?

Daytime phone _____ Cell phone _____ Home phone _____ Email _____

Please include a copy of your nominee's bio or resume if available.
Fax completed form to (718) 260-2579 Attn: Caribbean Life 40 Under 40 Awards
or Mail to: Caribbean Life

Attn: 40 Under 40 Awards
One MetroTech Center North, 10th Floor
Brooklyn, NY 11201

Online nomination submissions at
CaribbeanLifeNews.com/nominate.

Fictional tale of Elvis' twin brother fails to rock

The Identical

Fair (1 star)
Rated PG for smoking and mature themes
Running time: 107 minutes
Distributor: Freestyle Releasing

By Kam Williams

What if Elvis Presley's stillborn twin had survived his mother's pregnancy rather than passed away during delivery back in January of 1935? That is the alternate reality contemplated by "The Identical," a faith-based musical marking the underwhelming directorial debut of Dustin Marcellino.

Unfortunately, Dustin tapped an Elvis impersonator to star in his revisionist version of events, a dubious decision that comes back to bite him whenever Blake Rayne

isn't singing and shaking his hips onstage. The first-time actor plays both Ryan Hemsley and his identical sibling, Drexel (the Elvis in this fictionalized account of the life of the King of Rock and Roll).

The speculative endeavor's point of departure is Decatur, Georgia during the Depression, which is where we find poverty-stricken sharecroppers Helen (Amanda Crew) and William Hemsley (Brian Geraghty) fretting about how they're going to provide for their twin newborns. The answer to their prayers arrives soon thereafter, at a revival meeting pitched under a big tent by Reverend Reece Wade (Ray Liotta), a Pentecostal preacher with a soulful of hope and a barren wife (Ashley Judd).

The Wades' desire to start a family conveniently dovetails with the Hemsleys' having one more baby than they can reasonably afford. So, with God as their witness, Reece and Louise agree to adopt Ryan before surreptitiously



Blake Rayne playing the guitar in the movie "The Identical."

slipping out of town and back to Tennessee. Meanwhile, Helen and William announce the missing boy's death to friends and relatives, and stage a faux funeral, complete with an empty casket.

Reece proceeds to raise Ryan in the church with a career in ministry in mind although, given his

great vocal chords, the kid proves more comfortable in the choir than the pulpit. He rebels in his teens by enlisting in the military, leaving his domineering dad and a budding sweetheart (Erin Cottrell) behind. By contrast, Drexel, who was also blessed with powerful pipes, is allowed by the Hemsleys

to pursue his passion, and naturally blossoms into the nation's next singing sensation.

Will the twins ever learn of each other's existence? If so, will they be able to forgive their folks for having separated them at birth? And will Ryan ever enjoy an opportunity to take his own shot at fame and fortune?

These are the probing questions posed by a production so flawed in terms of plot, dialogue, and performances that it ends up unintentionally funny at practically every juncture.

Regrettably, "The Identical" flunks the basic plausibility test, whether in terms of its farcical reimagining of race relations in the Jim Crow South or its equally silly staging of sophomore car chases straight out of "The Dukes of Hazzard."

To paraphrase a Presley classic, only fools rush in to see a one-trick pony revolving around an annoying Elvis look-a-like.

Independent & Foreign Films

108 Stitches (R for profanity and sexual references) Ensemble comedy about a lousy college baseball team that schemes to go out on a high note after learning that the school president (Kate Vernon) plans to disband the program at the end of the season. Cast includes Bruce Davison, Erin Cahill and retired major leaguer Roger Clemens.

Altina (Unrated) Reverential biopic about Renaissance iconoclast Altina Schinasi (1907-1999), trendsetter, socialite, artist, inventor, feminist, civil rights advocate and bon vivant way before her time.

Archaeology of a Woman (Unrated) Justice delayed drama about a daughter (Victoria Clark) who unexpectedly uncovers clues to a long-unsolved crime of passion while caring for her mother (Sally Kirkland) suffering from Alzheimer's. With James Murtaugh, Karl Geary and Mary Testa.

Atlas Shrugged: Who Is John Galt? (PG-13 for violence and sexuality) Third installment in the ambitious adaptation of Ayn Rand's 1,200-page opus stars Kristoffer Polaha as



Kam's Kapsules

By Kam Williams

the title character, the man supplying the answer for the nation's impending economic collapse. Featuring Stephen Tobolowsky, Rob Morrow and Laura Regan.

Bird People (Unrated) Romance drama about a jaded, Silicon Valley engineer (Josh Charles) who quits his job and breaks up with his wife while in Paris on business in order to pursue a passionate affair with his young hotel maid (Anais Demoustier). With Roschdy Zem, Camelia Jordana and Geoffrey Cantor. (In French, English and Japanese)

Born to Fly (Unrated) Dance documentary chronicling the gravity-defying choreography of the legendary Elizabeth Streb.

The Disappearance of Eleanor Rigby: Them (Unrated) Final installment of the simultaneous trilogy, set in NYC, revolving around the trials and tribulations of a young couple

(James McAvoy and Jessica Chastain) struggling to save their marriage in the wake of a tragedy. Ensemble includes Viola Davis, William Hurt, Isabelle Huppert and Bill Hader.

The Drop (R for graphic violence and pervasive profanity) Screen adaptation of Animal Rescue, the Dennis Lehane short story about a lonely bartender (Tom Hardy) who launders cash for local mobsters only to become the focus of the police investigation in the wake of a robbery gone wrong. With Noomi Rapace, John Ortiz and the late James Gandolfini.

Faith Connections (Unrated) Spiritual documentary chronicling events unfolding at the Kumbh Mela, the triennial pilgrimage undertaken by 100 million worshippers to Allahabad, India to worship while sharing a bath in a sacred river. (In Hindi with subtitles)

LIAM NEESON A WALK AMONG THE TOMBSTONES



UNIVERSAL PICTURES and GROSS CREEK PICTURES present in association with EXCLUSIVE MEDIA and ENDGAME ENTERTAINMENT a JERSEY FILMS/DOUBLE FEATURE FILMS production
LIAM NEESON "A WALK AMONG THE TOMBSTONES" DAN STEVENS DAVID HARBOUR ROYD HOLLROOK executive producer MARY RAMOS director CARLOS RAFAEL RIVERA executive producer KERRY ORENT
ADI SHANKAR TRACY KROHN JOHN HYDE MARK MALLOUK LAUREN SELIG NIGEL SINCLAIR producer DANNY DEVITO MICHAEL SHAMBERG STACEY SHER TOBIN ARMOURIST BRIAN OLIVER
EXCLUSIVE
R
BASED ON THE NOVEL BY LAWRENCE BLOCK WRITTEN FOR THE SCREEN BY SCOTT FRANK AND DIRECTED BY SCOTT FRANK
A UNIVERSAL RELEASE

STARTS FRIDAY, SEPTEMBER 19
CHECK LOCAL LISTINGS FOR THEATERS AND SHOWTIMES

Go to www.Caribbeanlifefews.com for the latest in Caribbean news, entertainment, sports, business, viewpoints and more.

TOP OF THE CHARTS

TOP 10 SINGLES



- 1 **Stay With Me**
Sam Smith
- 2 **Rude**
MAGIC!
- 3 **Am I Wrong**
Nico & Vinz
- 4 **Boom Clap**
Charli XCX
- 5 **Maps**
Maroon 5
- 6 **Don't Tell 'Em**
Jeremih Featuring YG
- 7 **Shake It Off**
Taylor Swift
- 8 **Latch**
Disclosure Featuring Sam Smith
- 9 **All About That Bass**
Meghan Trainor
- 10 **Bailando**
Enrique Iglesias...

TOP 10 ALBUMS



- 1 **My Everything**
Ariana Grande
- 2 **Guardians Of The Galaxy:**
Soundtrack
- 3 **Moonshine In The Trunk**
Brad Paisley
- 4 **Promise To Love: Album IV**
Kem
- 5 **Blacc Hollywood**
Wiz Khalifa
- 6 **The Beauty Of ...**
G Unit
- 7 **In The Lonely Hour**
Sam Smith
- 8 **The Undoing**
Steffany Gretzinger
- 9 **Oxygen : Inhale**
Thousand Foot Krutch
- 10 **Beyonce**
Beyonce

Presented by
verizon wireless

Film shows

Continued from page 37

corner of Church and Flatbush Avenues. The itinerary for the evening was a demonstration by artist and painter Shakespeare Guirand from Haiti, a CaribBeing Pop-Up shop with T-shirt vendors, a photo booth with the organization's resident photographer Tiana Woods, a cultural visual presentation by Jouvett performers Pagwah, and a screening for the feature film "Masquerade," produced and directed in 1992 by Dalton Narine.

The film was a tribute to Peter Minshall during his time away at the Olympic Games. Minshall's band decided to do a band portrayal called Barcelona with costumes done in the Olympic colors of Spain while in that country done in tribute of their absent band leader. At that same time, Wayne Barkley, Minshall's band rival did a band portrayal called Titanic commemorating the history and tragedy of the doomed vessel. Wayne Barkley's band ultimately won the title of best band that year. Much of movie records Carnival done on the streets and not on the judges stage. According



Neighborhood residents sit down to view the screening of Dalton Narine's "Masquerade."

Photo by Kevin Bollers

to Narine, Carnival recorded on the streets with the dancing and singing was visually more sensual, raw and immediate.

CaribBeing has been doing this event at this location for the past three years. For Worrell, it is important to be in the heart of the community with cultur-

ally relevant programming that is truly and authentically Caribbean. Furthermore, the organization has a great relationship with the Reformed Protestant Dutch Church of Flatbush and they offered their venue to CaribBeing for indoor and outdoor events.

Looking forward into the Fall,

Shelley Worrell wants to relaunch the Flatbush Film Festival in a venue that can serve the community. Also, there are plans of launching an online store because people have been asking about the merchandise seen at their events. CaribBeing is constantly looking for ways to evolve.

Fashion

Continued from page 37

Week 2014 is produced by Face Of Fashion, a fashion modeling and fashion design management company located in New York City, under the direction of Carla Hazel. Face Of Fashion's primary goal is to emphasize the beauty of diversity in all nationalities. Face founder and CEO Carla Hazel stated that this goal can be achieved by opening doors to the global fashion market. This premier fashion event puts the spotlight on Caribbean fashion designers and models. The events provide the platform for all talents to showcase their inspirations in creative fashion designs for brand launching, as well as, the forum for fashion buyers and investors.

The aim of Caribbean New York Fashion Week 2014 was to fuel the business of fashion for Caribbean designers and models to take their skills and talent to the next level onto New York City International Fashion Stage. This is significant because participating talents become empowered and contribute to the fashion industry through Caribbean Fashion Tourism, thus bringing fashion at the



Model Kayeli walks the runway wearing an outfit made by Gillian Francis, aka Minka of Jamaica.
Photo by Kevin Bollers

forefront of participating Caribbean Islands to generate revenue for sustainable economic growth. A portion of the proceeds will be donated to Caribbean Tourism Organization foundation, which is a not-for-profit organization that provides scholarships and financial assistance to Caribbean nationals pursuing studies in tourism and hospitality.

Lisa Punch

Continued from page 37

home. "The response was great," added the songstress who wowed millions around the world with Whitney Houston's "How Will I Know," an outstanding performance that took her to the second round of the competition. She ultimately impressed judges in two more rounds with "Girl On Fire" and "Perfect" before she was eliminated.

Nicknamed "Knockout Punch," the talented 22-year old with a mellifluous voice raised eyebrows when she called Guyana a poor country during her video introduction on the show.

In the clip that was viewed by Guyanese around the world, Punch talked about growing up in a tiny house with her parents and siblings, and then moving to Brooklyn where she and her family shared a one-bedroom apartment.

This stirring revelation was felt deeply by people from Asia, Europe South, North America, and many other countries that amazed the singer who said she

received messages that said viewers were touch by her story.

But now, with a renewed vision, Punch, who was well received by her homeland at a musical festival recently, plans on recording pop music, and a reggae fusion to engage her fans.

The young diva who loves California where she said, "you could make your dreams come true," but is inspired by New York where "you could make them happen," believes that if you work hard and believe in yourself, "your dreams will come true."

"What you perceive, you will receive, I am staying positive, and humbled. Always pray, put God first, do your best and be yourself," were the words of wisdom from the up and coming star.

"I want to continue to inspire people," she added, "and I ask that my fans continue to support me."

With her new manager Mary Brown — songwriter for Destiny's Child, and Missy Elliot — at her side, Punch is working on her first album, and hopes to top the charts someday, and to help her family to succeed along with her.

FREE SEMINAR

Learn How To Live Healthy And Pain Free In One Hour

Presented by



SLIP/FALL ASSESSMENT & CONDITIONING PROGRAM

- Determine if you are at risk
- Identify risk factors
- Modify risk factors
- Improve balance and mobility
- Maintain an independent lifestyle

OCTOBER 15TH • 1 PM



ARTHRITIS

- Where does it come from and how does it start
- How do we slow it down
- What are the treatments both at home and in the office
- How does nutrition play a role

OCTOBER 29TH • 1 PM



KNEE/SHOULDER JOINT PAIN

- What's causing the pain
- A look at the anatomy and some common injuries
- What are the latest and innovative treatment options
- Am I going to need surgery

NOVEMBER 5TH • 1 PM



WEIGHT LOSS/STOP SMOKING PROGRAM

- Why can't I quit/why can't I lose weight
- Our unique approach to treatment
- What can I be doing at home to help

NOVEMBER 19TH • 1 PM



HEADACHES

- What is causing my pain
- Is it something I'm eating
- What are my treatment options
- Are medications my only choice

DECEMBER 3RD • 1 PM

Please call to register as space is limited

3500 Nostrand Avenue (Between Avenue U and V) TEL: 718-769-2521 www.HQBK.com

DEVELOP YOUR
WORK SKILLS.
INTERVIEW WITH
CONFIDENCE.
GET THE JOB
YOU WANT.

Click here to learn about the opportunities at the Workforce1 Healthcare Career Center



The Caribbean Diaspora's #1 Public Affairs Radio Program

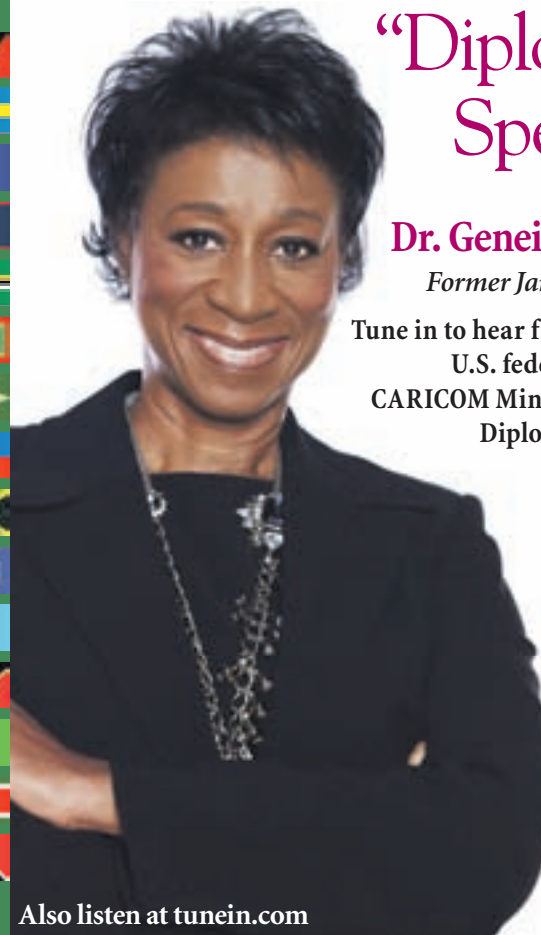

“Diplomatically Speaking”

with

Dr. Geneive Brown Metzger

Former Jamaican Consul General

Tune in to hear from the leaders in finance, U.S. federal and local government, CARICOM Ministers and Heads of State... Diplomats... Business Leaders...

The talk that keeps you updated and up to speed.

Sundays
4-5pm
93.5 FM



Sponsored by

Caribbean Life



Also listen at tunein.com

DiasporaDashboard.com

SUN KULCHA COMMUNITY EVENT

PRESENT-SUN., SEPT. 14

DANCE: Cumbe: Center for African and Diaspora Dance in Brooklyn kicks off the fall semester of youth programming with a special Pay-What-You-Wish. Students and parents are welcome to come try any class for a donation of any amount. To see the full schedule of classes, visit <http://www.cumbedance.com/youth-program-fall-2014>. Advance registration is highly recommended, as space is limited.

FRI., SEPT. 12

VARIETY SHOW: "No Name ... & A Bag O' Chips" comedy-variety show will feature comics Kevin Avery (head writer FX Networks "Totally Biased with W. Kamau Bell"), Jeff Kreisler (author "Get Rich Cheating"), and Brandon Scott Wolf ("Saturday Night Live Weekend Update") at Otto's. Showtime 7 pm No cover, no minimum. Otto's is located at 538 E 14th St (Cross Street: Between Avenue A and Avenue B). For more info, call (212) 228-2240.

SAT., SEPT. 13

FREE CREDIT SCORE AND ANALYSIS PROGRAMS: Ridgewood Savings Bank is deeply committed to the Bronx community's financial health and security and is hosting a free credit score program from 10 am - 2 pm. This program provides information which is critical in planning a successful financial future, including possible home ownership and business investment. 31626 Bruckner Boulevard, Bronx, NY; Please RSVP by calling (718) 589-1323.

INSURANCE POLICY: Are you covered adequately by your homeowner's insurance?



VARIETY SHOW

SEPT. 19: "No Name ... & A Bag O' Chips" comed -variety show will feature Liam McEneaney (Comedy Central's "Premium Blend"), comedian -pundit-blogger Leighann Lord (Fox News "Strategy Room"), Sharon Spell ("The Moth"), and sketch comedy collective Kokomo ("Upright Citizens Brigade Theatre"). The show starts at 7 pm and will feature house band The Summer Replacements. No cover, no minimum. Otto's is located at 538 E 14th St (Cross Street: Between Avenue A and Avenue B)

Are you paying too much? NHS will review your policy free of cost. We also speak to community groups about how the changing flood maps will impact your policy and flood insurance. For more information, call (718) 469-4679. Sponsored by Neighborhood Housing Services of East Flatbush, a not-for-profit housing organization. www.nhsnyc.org.

BLOCK PARTY: Berean Community and Family Life Center hosts its Ninth Annual "Takin' It to the Streets" block party from 11 am - 5 pm. The party will be held on Bergen Street between Utica and Rochester Avenue. Join us for free health screenings, entertainment, and school supplies. It's a family affair!

WED., SEPT. 17

HEALTH: The Alzheimer's Association NYC Chapter will host a free educational meeting, "Understanding Dementia" from 6 pm - 7:30 pm. The meeting will cover what you need

to know and where to go. 57 Willoughby St. Fourth floor. Please register by calling (800) 272-3900.

THURS., SEPT. 18

BOOK FESTIVAL: World-renowned author and journalist, Gail Sheehy and Girls who Code founder Reshma Saujani discuss the need to embrace risk and failure and to boldly chart your own course. Sheehy's new memoir, *Daring: My Passages*, chronicles the obstacles she encountered when she blazed a trail in the male-dominated world of journalism in the 1960s. Her earliest book, *Passages*, was named by a Library of Congress survey one of the ten most influential books of our time. Saujani, a former New York City Deputy Public Advocate, founded Girls Who Code to close the gender gap in technology and prepare young women for jobs of the future. Saujani's new book is *Women Who Don't Wait in Line*. This event starts at 7

pm Brooklyn Central Library, Dweck Center (10 Grand Army Plaza, Brooklyn, NY 11238)

FRI., SEPT. 19

MUSIC: New York-based blues favorites Renee and the Derelicts perform classic and original blues, rock and soul tunes featuring the vocals of the multitalented actress/playwright Renee Flemings, the band Sal Carolei (blues harp), Paul Bauman (guitar), Trevor Brown (bass), and Bernard Devlin (drums) will kick things off at 9 pm. No cover, great Mediterranean food and drink available. LURA Restaurant NYC is located on the upper West side (949 Columbus Ave) between 106th & 107th street. For more information, call (212) 866-7500.

VARIETY SHOW: "No Name ... & A Bag O' Chips" comed -variety show will feature Liam McEneaney (Comedy Central's "Premium Blend"), comedian -pundit-blogger Leighann Lord (Fox News "Strategy Room"), Sharon Spell ("The Moth"), and sketch comedy collective Kokomo ("Upright Citizens Brigade Theatre"). The show starts at 7 pm and will feature "No Name" house band The Summer Replacements featuring Carl (BabyFreak) Fortunato and Fernando (Dr. Sandman) Morales Gonzalez. No cover, no minimum. Otto's is located at 538 E 14th St (Cross Street: Between Avenue A and Avenue B)

If you have an event that you would like to post in Sun Kulcha, please email your submission to Caribbeanlife@cnglocal.com. All submissions are subject to a review by the editor. — compiled by Natalie Y. Henry

CYNTHIA KING DANCE STUDIO

21 Snyder Ave, Brooklyn, NY 11226 718.521.4043
1256 Prospect Ave, Brooklyn, NY 11218 718.437.0101

Cynthia King Dance Studio has a new Flatbush location!

Now accepting students for 2014-15

Classes for children and adults
BALLET • HIP HOP • MODERN • AFRICAN TAP • BREAKDANCING • DANCEFUSION

New students save \$25 with this ad

www.cynthiakingdance.com

Cars4Kidneys.com

Donate your Car, Truck, RV, Boat, Plane, or Real Estate to help people needing organ transplants on **MatchingDonors.com**.

1-800-385-0422

Our 501c3 nonprofit benefits by receiving the proceeds of the donation, and you receive the great tax deduction!

Healthy Gums And Teeth For A Lifetime!

Gentle And Effective Treatment! St. Marks Painless Dental



Painless Laser Treatment

If you are afraid, come to St. Marks Painless Dentistry. Say good-bye to painful needles and annoying drills. We are the first in the area to use a dental laser that, in most cases, eliminates the use of drills and needles. Amazing equipment and state-of-the-art methods will make your next dental visit enjoyable and stress free.

IV Sedation (Sleep Dentistry)

Discover a whole new world of comfortable and painless dentistry. Our top priority is to eliminate your fears.

Implants

Based on years of experience and a multitude of completed cases we strongly believe that it is most beneficial for a patient to have all stages of Implantology performed at one clinic. We will design your case, perform the surgery, insert your teeth and maintain them. It makes the whole process smooth, painless and affordable.

Gum Treatment/Bone Grafting

We provide comprehensive periodontal treatment including bone grafting.

Cosmetic Dentistry

• White fillings at no extra cost • Laser Bleaching (takes only one hour) • Bad breath treatment

Orthodontic Treatment & Invisalign

We combine the best achievements of European and American orthodontics to eliminate unnecessary extractions. We proudly hold a status as a PREFERRED PROVIDER given to us by Invisalign.

Dental Laboratory on Premises

Repair your old dentures while you wait.

Implants • TMJ Treatment (Jaw Joint) • Bridges • Root Canals

*A Staff That Cares,
Doctors Who Truly Listen
And Treat With Love!*



FREE
INITIAL CONSULTATION
Do Not Hesitate To Visit
St. Marks Painless Dental

St. Marks Painless Dental
907 St. Marks Ave.
Bet. Albany & Kingston Aves.
718-778-3283

ECONOCARIBE
Since 1968
International Transportation Specialists
"Your Personal Shipping Solution"

For Excellent Rates Contact us!

718-244-SHIP (7447)

147-46 176th Street
Jamaica, NY 11434
(At the back of DMV)

TRINIDAD & TOBAGO	JAMAICA	DOMINICA
ST. LUCIA	BAHAMAS	PANAMA
NICARAGUA	ANTIGUA	HAITI
BERMUDA	DOMINICAN REPUBLIC	ST. KITTS
PUERTO RICO	GRENADA	ST. MARTIN
ST. VINCENT	GUYANA	BELIZE
US VIRGIN ISLANDS	BARBADOS	CAYMAN ISLANDS

We Sell Empty Barrels

TRINIDAD • POS

FALL SPECIAL
JUMBO BARREL
\$59.00

includes pick up in Brooklyn, Bronx and Queens
(expires 09/30/14)

ship@econocarib.com
www.econocarib.com

STOP PAYING FOR TV that you should be getting for free!



Crystal Clear High Definition TV
NO CONTRACT! NO BILLS! NO HASSEL!
212.377.3124

TENNAVISION
PROVIDING FREE HD TV
www.tennavision.com
Specializing in residential, commercial and MATV installations and repairs

\$25 OFF
ANY NEW INSTALLATION
With this coupon only. Expires 9/29/14

GET A FRIEND & GET \$25
FOR EVERY NEW CUSTOMER YOU SEND US
With this coupon only. Expires 9/29/14

West Indian Parade organizers say 'Thank you'

West Indian American Day Carnival Association

The members of the West Indian American Day Carnival Association are thankful that 2014 Carnival celebrations will go down in history as one of the most enjoyable and safest Carnival seasons. No incidents were reported by the NYPD during the parade or after the festivities.

Consistent with prior years, the Carnival was preceded by four days and nights of cultural events on the grounds of the Brooklyn Museum, followed by a special Champagne Breakfast on Labor Day as hundreds rubbed shoulders with dignitaries and grand marshals — Mayor DeBlasio, Borough President Adams, District Attorney Ken Thompson, and CEO of ad agency giant Monique Nelson, NYPD Commissioner William Bratton, and Chief



(Left) The DeBlasio family marches as one at the head of the West Indian Day Parade, which often brings as many as a million people to Crown Heights for the day of celebration of Caribbean culture. (Right) Yvette, left, and Una Clarke at the 47th annual West Indian Day Parade last week.

of the Department Phillip Banks before joining grand marshal, Gov. Cuomo at Schenectady Avenue and Eastern Parkway.

The special line-up of powerful leaders lead off the Carnival Parade of more than 70 floats, marching

bands, other groups, and thousands of costumed masqueraders that depicted every imaginable creation that showcased true Caribbean and West Indian culture. Scores of huge flatbed tractor-trailers stacked high with gigantic music systems



Photo (left) by Paul Martinka, Photo (right) by Tequila Minsky

provided the chest-humping music that prompted the frenzied gyrations by everyone within ear-shot.

The Association extends profound thanks to all of its sponsors, including: Con Edison; Delta Airlines; Emblem Health; Money-

Gram; Brooklyn Museum; NYSCA; Healthfirst; Transport Workers Union; Brooklyn Chamber of Commerce; Caribbean Life; United Federation of Teachers; the Daily News; MCU; Bacardi USA; Guinness; Heineken USA; DYCD; McDonald's; Barten-

ura; PIX 11; News 12; WBLS 107.5 FM; Hot 97 FM; Hard Beat Communications; Irie Jam Media; and AllCar Rent A Car-Carpingo; We also thank our pro-bono law partners, Dechert LLP, Lawyers Alliance; Duane Morris LLP; and many other supporters as well as our partners who helped by selling tickets for the Museum concerts: Brooklyn Museum; Charlie's Records; Tropical Paradise; Flamingo; D' Savannah; and Sugarcane Restaurants.

Finally, the Association's gratitude goes out to Borough President Adams and his staff for their valuable assistance.

And we sincerely appreciate the hard work and dedication exemplified by dozens of Mas Band leaders and staff, thousands of costumed masqueraders, more than 1,000 Steelband musicians and their leadership, hundreds of volunteers, vendors, its membership, Funsation Media, Klust Creative, LightSourceCS.com, AM Creative Group, Marco-151polo Inc, and every level of the NYPD who were invaluable to the overall success of this year's events and who each showed the world that real partnership works.

The Law Offices of Georgia E. McCarthy



902 East 86 Street, Brooklyn NY 11236

CONTESTED/UNCONTESTED DIVORCES

Aggressive Representation in Supreme Court and Family Court

FAMILY LAW

CHILD SUPPORT, CUSTODY, PATERNITY, VISITATION AND CHILD ABUSE

Protect Your Parental Rights in Family Court

REAL ESTATE

Contracts & Closings, Foreclosures, Basement Ejections

CRIMINAL MATTERS

IMMIGRATION • BANKRUPTCY • ALL CIVIL MATTERS

TRUST, WILLS & ESTATES REPRESENTATIONS

Free Consultation

Call 347-587-5458 • Fax 347-587-6169

BY APPOINTMENT ONLY



McManus FUNERAL HOME



On Site Parking • Large Chapels & Lobby • Worldwide Shipping

OUR SUMMER 2012 INTERIOR RENOVATION IS COMPLETE

*Before choosing a funeral home
We invite you to visit our newly decorated chapels
And compare our affordable pricing and dedicated service*

718-377-5200 • www.mcmanusfh.com
4601 Avenue N (at E. 46 St.) • 1 Block off of Flatbush Ave.

Happiness for couples is a satisfying love life.



Support for male virility!



- Bell Forza # 79 is a new formula packed with herbs, amino acids and other fantastic ingredients.
- May also foster healthy circulation, virility and strength, thereby creating the proper conditions for a healthy erection.*
- Epimedium extract (also known as "Horny goat weed") and cowitch extract included in the formula may help to peak sexual interest.*
- One of the many other ingredients Maca, is native to the high Andes mountain range in Peru and is historically known to balance natural hormonal processes.
- Don't settle for ho-hum performance. Enhance your love life and strive for excellence! Easy to take capsules. Ask for Bell Forza #79 at one of the many fine retailers listed below.*

Desire and Passion! Nutritional support for a woman's natural vigor.

- Supplement your diet with these easy to take capsules designed to stimulate desire and passion while increasing stamina and peaking interest in sexual activity.*
- Ashwagandha extract is used as an adaptogen to help the body cope with daily stress and as a general tonic. Also, ashwagandha is known to help prevent signs of aging.*
- L-Arginine, an amino acid that is converted in the body into a chemical called nitric oxide. Nitric oxide causes blood vessels to open wider to improve blood flow. L-Arginine also stimulates the release of growth hormone and insulin which are very healthy factors and are attributed to youthfulness.
- Ask for Bell Amora #80 at one of the fine retailers listed below. *



Frequent Bathroom Trips?



Men: Bell Ezee Flow Tea #4A is nature's nutritional support for urinary comfort, balance and ease.

- Helps maintain urinary flow, frequency and comfort, with a good night's sleep.
- Guaranteed to make urine flow easier again.* Relief from dribbling, discomfort, burning, urgency, poor flow.*
- Formulated using many herbs, such as chamomile, cranberry, willow flower, saw palmetto and many more.
- We have had thousands of satisfied repeat customers.
- Tastes great hot or cold!

Testimonials from everyday people:

- **I feel like another person with no more frustrations!** It is phenomenal! It's unbelievable. I'd like to thank Bell. I will get other Bell products. Thank you again! *Richard Dorvilus, 55, Elmont, NY.*
- **Ezee Flow tea gave back good sleep and health!** I feel like I'm 30 years old. During the night I hardly have to go to the toilet anymore. What a feeling. Because I sleep well, I'm not tired anymore during the day. "Old age" was bearing down on me. Now I feel great again and healthy. *Jerry H. Cole, 73, Lansing, IL.*
- **I'm truly amazed and relieved.** After just 2 weeks of drinking the Bell Ezee Flow Tea I no longer have to get up during the night. I'm enjoying a normal sex life. This product is so incredible. I enjoy drinking the tea. I hope that a lot of men with a pride issue give this a shot. It's difficult to express how delighted I am. *Clarence A. Rehrig, 58, Allentown, PA. **

Bell Bladder Control Tea for Women #4b

Satisfaction guaranteed (see box) for incontinence and control.* This inexpensive, pleasant tasting herbal combination tea is safe and effective. Put an end to embarrassments and discomfort. Support the bladder and urinary tract with these all natural ingredients. Tastes great hot or cold!

Testimonials from everyday people:

- **I wish I had found this tea sooner!** A family member told me that she used the Bell Tea for Women #4b with positive results. What a wonderful product. It also worked for me. *Australia P. Rodriguez, Rego Park, NY.*
- **Plan to keep taking it as long as I live!** One of the clerks in my local health food store recommended the Bladder Control Tea #4b. I was very skeptical. What a surprise it worked! 5 days after starting the tea I noticed a major improvement and it is continually getting better each day. I plan keep taking it for as long as I live. Thank you! ** Frances Baird, 87, Venice, FL.*
- **Exercises didn't help!** After drinking the Bell Tea for Women #4b my life is far less stressful especially when I am at work. Thanks for such an amazing product! *Marilyn Sallows, 53, Fort McMurray, AB*
- **Tea represents truth in advertising!** Being a skeptic, I ordered this Bladder Control Tea for Women as a more or less last resort, after trying everything else in the last 5 years. It worked better than I hoped for. Thank you for this great product, and above all, for truth in advertising. *Marina Rosa, 57, Las Vegas, NV**



* These statements have not been evaluated by the Food and Drug Administration. This product is not intended to diagnose, treat, cure or prevent any disease.

100% Truthful testimonials. Real people who want to tell everybody about their relief.
No money is paid for testimonials. Many more testimonials on our website.

■ **AVAILABLE IN QUEENS:** ■ **SPRINGFIELD** Health Conscious Natural Foods 231-22 Merrick Blvd ■ **ASTORIA** Strand Pharmacy 2501 Broadway Astoria Chemist 2501 30th. Ave Astor Pharmacy 3518 Dilmars Blvd. ■ **BELLEROSE** Rocky Hill Pharmacy 23601 Braddock Ave ■ **CORONA** Value Pharmacy 5917 Junction Blvd ■ **FAR ROCKAWAY** Redfern Drugs 1485 beach Channel Dr. ■ **FLUSHING A C** Northern Pharmacy 154-16 Northern Blvd Franconia Pharmacy 4502 162nd St. Lewis Pharmacy 13698 Roosevelt Ave Victoria Pharmacy 44-45 Kissena Blvd ■ **FOREST HILLS J & D** Pharmacy 7168 Yellowstone Blvd ■ **FRESH MEADOWS** Ilana's Pharmacy 180-30 Union Turnpike Echo Drugs 70-35 Parson Blvd ■ **HOWARD BEACH** Howard Beach Apothecary 158-40 Crossbay Blvd ■ **JACKSON HEIGHTS** Jackson Heights Health Food Store 83-10 37th Ave. Frank's Pharmacy 74-21 37th Ave Maram Pharmacy & Surgical 7701 37th Ave Mi Farmacia 9015 Roosevelt Ave Superior Pharmacy 7814 Roosevelt Ave Vitamins & Homeopathy Center 72-15 35th Ave ■ **JAMAICA** Queens Community Expert Pharmacy 168 12 Hillside Ave Hillside Pharmacy 18420 Hillside Ave Variety Drugs 16933 137th Ave ■ **LONG ISLAND CITY** Vernon Pharmacy Inc. 4815 Vernon Blvd. ■ **LITTLE NECK** Little Neck Health Connection 24516 Horace Harding Expwy ■ **MASPETH** Eagle Pharmacy 6402 Flushing Ave ■ **REGO PARK** Arcola Pharmacy 65-45 99th St ■ **RIDGEWOOD** Kraupner Pharmacy 6686 Fresh Pond Rd Mil-Rue Chemists 6687 Fresh Pond Rd ■ **SAINT ALBANS** Vital Health Food 196-14 Linden Blvd Mind Body & Soul 189-28th Linden Blvd. ■ **SUNNYSIDE** Go Natural Health Food 4503 Queen Blvd ■ **AVAILABLE IN LONG ISLAND:** ■ **VALLEY STREAM** Dale Drugs 531 West Merrick RD. ■ **CORAM** Yore X Drugs 1850 Route 112 ■ **EAST HAMPTONS** Liggett Drugs 39 W.Montauk HWY. ■ **HICKSVILLE** GNC #2492 481 Broadway Mall ■ **MIDDLE ISLAND** The Natural Vitamin & Herb Source 770 Middle Country Rd ■ **WHITESTONE** GNC 153-29 Cross Island Pkwy. ■ **BRENTWOOD** Brentwood Pharmacy 761 Suffolk Ave # 1 ■ **SOUTHAMPTON** Southrifty Drug 54 Jagger Ln ■ **GARDEN CITY PARK** 2443 Jericho Turnpike ■ **EAST HAMPTON** East Hampton Pharmacy 106 N. Main St. ■ **SELDEN** Quality Pharmacy 249 Middle Country Rd ■ **SHOREHAM** Shoreham Drug 99 Route 25A, #1 ■ **N. BALDWIN** Natures Vitamin Spot 1211 Grand Ave.



Bell products are available at the above store locations, on our website or call us with Visa or MasterCard. S & H \$9.95.
1-800-333-7995
www.BellLifestyle.com

Bell uses the power of nature to help put life back into your lifestyle

We Cover Brooklyn Better Than Anyone.



Grow your business with Brooklyn's largest publication group

With a combined Brooklyn circulation of over a quarter million, our Brooklyn based newspapers and magazines beat the competition hands down.

Why?

Because we've got more history: We've been doing it for 70 years.

More stories: No one has a bigger, more dedicated editorial staff.

More breaking news: Our websites are updated throughout the day.

So when it comes to getting your message out to Brooklyn there's only one choice. And it's not even close.

For information about advertising in CNG's Brooklyn publications call **Jennifer Stern at 718-260-8302** or email js Stern@cnglocal.com



SPORTS

FOR MORE SPORTS, GO TO CARIBBEAN LIFE ONLINE

Bulls roll behind Wright-Phillips

By Patrick Horne

Bradley Wright-Phillips and Thierry Henry are the most in-form scoring tandem in Major League Soccer this season. The pair scored 29 of the New York Red Bulls' 37 goals in the regular season, with Wright-Phillips carrying much of the load with a league-high 21 goals, just six short of the league record for goals in a season.



Red Bulls forward Bradley Wright-Phillips heads the ball.

AP / Adam Hunger

Meanwhile, Henry is in full support with eight tallies and a team-high 11 assists.

The pair worked in tandem last Saturday night at Red Bull Arena to defeat the defending champion Sporting

Kansas City, 2-1, when Wright-Phillips gave the Red Bulls (8-8-10, 34 points.) the lead and Henry secured the winner to the delight of 20,831 fans.

Wright-Phillips, who was fully aware of playing against his main rival for the league scoring title — fellow Englishman Dom Dwyer, who has 18 goals — wasted no time in getting on the score sheet. He buzzed

Continued on Page 48

No rush to name Windies coach

By Azad Ali

West Indies Cricket Board chief executive officer Michael Murihead said there is no rush to appoint a coach of the regional team.

"We don't plan to rush this process. We will go through each interview at our own pace and no one will be given preferential treatment. The response has been good so far," he said.

Murihead said the Board will not be lim-

Continued on Page 48



Serena Williams, of the United States, holds the championship trophy after defeating Caroline Wozniacki, of Denmark, during the championship match of the 2014 U.S. Open tennis tournament, Sunday, Sept. 7, 2014, in New York.

AP Photo/Darron Cummings

Serena amazes with third-straight Open win

By Robert Elkin

In tennis what else is now new? Serena Williams defended her United States Open Singles Tennis title. Everybody in the capacity crowd of more than 20,000 fans from all over the world were amazed how she accomplished that remarkable

feat by taking her third-consecutive singles crown and sixth overall since she won her first in 1999.

Some officials, fans, and players became certainly stunned with her performances especially over 10th-seeded Caroline Wozniacki of Denmark, 6-3, 6-3,

in a quickly contested match to end a very successful Open for her. And she closed out her match with seven aces in the final match.

"Serena Williams has established herself as one of the greatest players of

Continued on Page 48



Serena Williams, of the United States, reacts after a point in the championship match against Caroline Wozniacki, of Denmark, in the 2014 U.S. Open tennis tournament, Sunday, Sept. 7, 2014, in New York. (AP Photo/Darron Cummings)

Darron Cummings

Williams' win amazes tennis fans

Continued from page 47
all-time," said World Tennis Association Chairman and CEO Stacey Allaster.

She has certainly gone into the record books and continuously does so along with those already there such as Stefi Graf, Monica Seles, and Chris Evert just to name a few of the female greats during the Open era. She now is headed toward the BNP Paribas in mid-

October.

"She will be a fan-favorite," Miss Allaster added. "Her success in the finals is an incredible treatment to her ability."

Players from the Open, which included some big-name men's upsets, pulled for Williams. She was very much prepared for the tournament and didn't lose a single set.

Serena certainly has the

talent to pull off an incredible moment.

"I didn't believe that talent can last everything," said Wozincki. "Williams is a hard worker. When she does that she can pull off that big serve. She has the power. She can push us back on the court and take that initiative. She certainly has the power to do so. I think that makes it even harder."

"She's an amazing player," added another player, who wanted to remain anonymous. "She said a long time ago that nobody can beat her, but only herself can."

This resident, once from Delaware is now residing in Edison, New Jersey.

Almost everybody agreed that Serena Williams is an amazing player and she is continuing to look toward a great career.

son was axed prior to the start of the One-Day International against Bangladesh in Grenada.

Gibson spent two years in charge of the team, which captured the 2012 World Twenty20 in Sri Lanka.

Significantly, the West Indies are without a coach

ahead of their Test and ODI tour of India starting in October and the World Cup which starts in Australia and New Zealand next February.

Murihead said the WICB would not be pressured into a deadline because of pending tournaments.

Soccer update

Continued from page 47
around the Kansas City (12-10-6, 42 points.) goal area, which led to a foul on the forward committed by Kansas City defender Matt Besler; Wright-Phillips scored the resulting penalty kick to give the Red Bulls a 1-0 lead in the 11th minute, which New York carried into the second half.

As has been the norm this season, Henry followed his scoring partner onto the scoring sheet with what turned out to be the winner in the 52nd minute. The former French international scored what was referred to as a "world-class strike" when he received a pass from midfielder Lloyd Sam and beat Sporting Kansas City goalkeeper Andy Gruenebaum for the 2-0 lead.

It was as if Dwyer felt obligated to respond and stay in the scoring race, and he did by pulling a goal back for the visitors in the 54th minute; Dwyer fell short on two occasions earlier in the contest but not this time, as he hit a ball that was headed downward in the New York goal area by Seth Sinovic and beat Red Bulls goalkeeper Luis Robles.

Around the league

In other Major League Soccer games last weekend, host Houston Dynamo defeated the Montreal Impact 3-2 behind two goals from Giles Barnes (30th, 62nd, minutes) and a winning tally from Ricardo Clark (65th); Dilly Duka (40th) and Ignacio Piatti (55th) scored for Montreal. Real Salt Lake registered a 2-1 win over FC Dallas when Costa Rican international Javier Saborio (77th) broke a 1-1 tie; Robbie Findlay scored Salt Lake's first goal and Michel registered for FC Dallas. Meanwhile, DC United and the Vancouver Whitecaps played to a goal-less draw.

The Philadelphia Union is still improving while Toronto FC seems to be regressing; Philadelphia knocked off the host, 2-0, behind first-half goals from Conor Casey and Andrew Wenger. Toronto



New York Red Bulls forward Thierry Henry gestures after the MLS All-stars beat Bayern Munich in the second half of the MLS soccer All-Star match, Wednesday, Aug. 6, 2014, in Portland, Ore.

AP Photo/Ted S. Warren

is now coached by former USA international Greg Vanney, who replaced Ryan Nelsen last Sunday.

Bocanegra to retire: Former Team USA defender and captain, Carlos Bocanegra announced Thursday that he will retire at the end of the 2014 season. The 35-year-old, who plays for Chivas USA in Major League Soccer, enjoyed a 15-year professional career in which he played for the American league's Chicago Fire, Fulham FC of the English Premier League, Glasgow Rangers of Scotland, Renne in France and Racing Santander in the Spain. Bocanegra is considered as one of the most successful American players. He represented the USA in 110 matches, including two World Cups (2006 and 2010), scored 14 goals (a record for a U.S. defender) and captained the national team 64 times, with 34 victories, another record for a U.S. player.

"Carlos has been an outstanding ambassador for U.S. Soccer," United States Soccer Federation president Sunil Gulati said. "As a player, a captain and a leader, he has epitomized the best of what it means to be a member of the National Team throughout his career. We are all extremely proud of everything he has accomplished, and look forward to working with him in continuing to help grow the sport in the country."

Cricket coach

Continued from page 47
iting itself to regional applicants only.

"We have spoken to several coaches. Some of them are from the region

and some of them are from the outside. The interest in the position has been very high," the Jamaican said.

The post became vacant when Barbadian Ottis Gib-

\$0 DOWN AVAILABLE

It's a SEPTEMBER To REMEMBER!

SAVE BIG ON NISSAN'S & INFINITI'S



HUGE CERTIFIED PRE-OWNED INVENTORY ALL MAKES! ALL MODELS!



2011 NISSAN ALTIMA COUPE **LOW LOW MILES** BUY FOR **\$17,995**
Stk #1568, 16,139 mi., 4 cyl, auto, air, nav, lthr, moonroof, spoiler, Bluetooth



2011 NISSAN SENTRA SR BUY FOR **\$11,995**
Stk #1482, 21,856 mi., 4 cyl, auto, air, full power, cd, aero body kit, Bluetooth, Spoiler, Alloys



2009 NISSAN ALTIMA SL BUY FOR **\$11,995**
Stk #1533, 60,639 mi., 4 cyl, auto, sunroof, leather, htd sts., cd, alloys



2014 NISSAN VERSA SL **884 MILES** BUY FOR **\$12,995**
Stk #1429, 884 mi. 4 cyl, auto, air, cd, cruise, tilt, balance of factory warranty



2012 NISSAN ALTIMA S BUY FOR **\$13,995**
Stk #1394, 40,961 mi., 4 cyl, auto, air, fullpower, cd



2011 NISSAN ALTIMA SPECIAL EDITION BUY FOR **\$13,995**
Stk #1386, 28,001 mi., 4 cyl, auto, air, spoiler, alloys, full power, cd, wheel controls



2011 NISSAN ROGUE SV AWD BUY FOR **\$15,995**
Stk #1571, 27,651 mi., 4 cyl, auto, air, full pwr, cd, cruise, tilt, folding sts., pwr st. Bluetooth, back up cam, Alloys



2012 NISSAN ALTIMA SL BUY FOR **\$16,995**
Stk #1444, 30,457 mi., 4 cyl, auto, air, sunroof, lthr, heated sts., back up cam, Bluetooth



2009 NISSAN MAXIMA S BUY FOR **\$18,995**
Stk #1434, 29,971 mi., V6, auto, air, moonroof, alloys, power seats, audio control, CD, Bluetooth, spoiler



2009 NISSAN MURANO LE AWD **NAVI** BUY FOR **\$19,995**
Stk #1525, 34,405 mi., V6, auto, air, panoramic roof, leather, bluetooth, htd sts., alloys, back up cam



2011 NISSAN MAXIMA SV PREMIUM TECH **LOADED** BUY FOR **\$19,995**
Stk #1573, 35,450 mi., V6, auto, nav, leather, htd sts., Bluetooth, back up cam, panoramic, rear shade, music box



2012 NISSAN JUKE SL AWD BUY FOR **\$19,995**
Stk #1567, 25,770 mi., 4 cyl, auto, air, nav, sunroof, lthr, Bluetooth, back up cam



2013 NISSAN PATHFINDER SV AWD BUY FOR **\$24,995**
Stk #1565, 27,419 mi., 6 cyl, auto, air, 3 rows, Bluetooth, full power, alloys, back up cam



2009 TOYOTA RAV4 4WD BUY FOR **\$9995**
Stk #1578, 99,543 mi., 4 cyl, auto, air, 4WD, full power, sport wheels, cd, cruise



2013 HONDA FIT SPORT 5D HB BUY FOR **\$13,995**
Stk #1546, 7488 mi., 4 cyl, auto, air, full power, alloys, spoiler, cd, tilt-tele



2009 TOYOTA CAMRY XLE BUY FOR **\$15,995**
Stk #2737, 24,460 mi., 6 cyl, auto, air, nav, moonroof, lthr, heated/power sts.



2010 INFINITI G37X AWD BUY FOR **\$15,995**
Stk #U4786, 71,260 mi., navigation, moonroof, leather, back up cam, memory sts.



2011 INFINITI G37X AWD **NAVIGATION** BUY FOR **\$21,995**
Stk #U4802, 13,880 mi., V6, auto, Bluetooth, nav, leather, moonroof, back up cam



2010 INFINITI EX35 AWD BUY FOR **\$22,995**
Stk #U4773, 44,478 mi., V8, auto, air, nav, moonroof, leather, heated, Bluetooth



2011 INFINITI M35X AWD BUY FOR **\$26,995**
Stk #U4735, 35,421 mi., V6, auto, air, navi, sunroof, leather htd & cooled seats, back up cam



2011 INFINITI M35X AWD BUY FOR **\$26,995**
Stk #U4735, 35,421 mi., V6, auto, air, nav, sunroof, back up cam, Bluetooth, htd/cooled sts.



2012 INFINITI G37X AWD BUY FOR **\$27,995**
Stk #1385, V6, auto, nav, moonroof, leather, back up cam, Bluetooth, white, 13,477 mi.



2012 INFINITI G37X AWD BUY FOR **\$28,995**
Stk #U4758, 13,484 mi., V6, auto, air, nav, leather, moonroof, Bluetooth, htd/cooled sts.



2011 INFINITI FX35 AWD BUY FOR **\$31,995**
Stk #U4820, 19,401 mi., 6 cyl, auto, air, nav, moonroof, leather, heated/colled memory sts., Bluetooth, back up cam



2011 INFINITI FX35 AWD **ONLY 4829 MI.** BUY FOR **\$32,995**
Stk #U4821, 4829 mi., 6 cyl, auto, air, nav, moonroof, leather, heated sts., Bluetooth, memory sts.



2010 SUBARU FORESTER X AWD **LOW MILES** BUY FOR **\$13,995**
Stk #1541, 37,558 mi., 4 cyl, auto, air, full power, cruise, cd



2013 HYUNDAI SONATA GLS BUY FOR **\$16,995**
Stk #U4783, 12,701 mi., 4 cyl, auto, air, back up cam, alloys, full power, cd, balance of factory warranty



2011 HONDA ACCORD EX-L BUY FOR **\$17,995**
Stk #U4771, 21,800 mi., V6, auto, air, moonroof, htd, lthr, pwr memory sts., Bluetooth, alloys, cd



2011 HONDA PILOT AWD BUY FOR **\$22,995**
Stk #1581, 27,164 mi., 6 cyl, auto, air, nav, lthr, heated, back up cam, moonroof



KINGS NISSAN
2758 Coney Island Ave. Brooklyn, NY 11235
888-485-4647
KingsNissan.com

KINGS INFINITI
20 Neptune Avenue Brooklyn, NY 11235
888-925-4647
KingsInfiniti.com

Tax, tags & MV fees additional. *Certification available on select models. All vehicles sold cosmetically as is. Offers subject to primary lender approval which may affect rate and or payment. Kings Infiniti NYC DCA #0414427, NYS DMV #7048732, 7104527, Kings Nissan NYC DCA #0671140/#1362991, NYS DMV #7015016. All vehicles available on a first come first sold basis.



CYCLONES CONFIDENTIAL

Here they are: Your 2014 Clonie Awards!

BY BROOKE CORTESE

Entertainment types are big on awards. The music industry has the Grammys, Hollywood has the Oscars, and teenage consumers of pop culture have their Teen Choice Awards. But it's easy to forget all that noise when you're sitting in the stands at MCU Park, feeling the sea breeze and watching the Clones miss a shot at the championship by a hair yet again (this was the Mini-Mets' 14th consecutive above-.500 season, and 13th straight without a championship).

That is why The Brooklyn Paper has its very own set of annual honors dedicated to all things Cyclones. So sit back with some peanuts and Cracker Jacks as we christen the heroes of a nail-biter of a season.

(Insert commercial break here.)

The envelope, please.

The David Wright Iron Man Award

And the Clonie for endurance goes to third baseman



SAFE! Jhoan Urena is our Iron Man.

Photo by Steve Solomonson

Jhoan Urena, one of the youngest members of the Clones roster this season, and one of the most consistent. Urena turned all of 20 during the last week of the season but maintained a solid .300 batting average all summer long. He played in 75 games, missing only the Aug. 25 game against the hated Staten Island Yankees when he was ejected ahead of the game for staring down the Baby Bombers dugout from the field.

The "You Gotta Believe!" Award

And the Clonie goes to **Casey Meisner**. The tall, right-handed pitcher started the season with several no decisions before going an awful 0-3, including a heart-wrenching 18-2 loss on Seinfeld Night. But then, starting with his first win on Aug. 4, Meisner did a complete 180 and went on to collect five consecutive wins, earning double-digits strikeouts during two games. Sometimes you just gotta believe.

The Off to the Races Triple Crown Award

And the Clonie goes to **Marcos Molina**. This workhorse broke out ahead of the pack to lead, then swept the New York-Penn League in all three of the top pitching statistical categories: wins, earned-run average, and strikeouts. Pitching was never the Cyclones problem this season and having the top pitcher in the league sure didn't hurt.

The Ringer Award

And the Clonie goes to **Michael Conforto**. The 10th-top-paid Major League Baseball draft pick was a wise purchase for the Mets and a boon for Brooklyn's home team. The 21-year-old Oregon State University junior came out swinging to break an eight-game losing streak in July and start his career with a 10-game hit streak. He went on to change the way the team played. Conforto's arm helped out as well, as he made several assists from left field.



RACEHORSE: Marcos Molina was the best pitcher in the league this year. Photo by Steve Schnibbe



RINGMASTER: Michael Conforto is the one ringer to rule them all.

Photo by Steven Schnibbe

The Steve Cohen Executive of the Year Award

He's done it again! Cyclones vice president **Steve Cohen** set Michael Conforto to slugging and steered the team through yet another fun-packed season, featuring hit theme nights such as Seinfeld Night, '90s Night, and "Star Wars" Night, not to mention landing MCU Park a minor league football team that will keep him — and MCU staffers — busy through the fall.

The Don't Call it a Comeback Award

And the Clonie goes to, you guessed it, Clones manager **Tom Gamboa**, who returned to the team after a three-year hiatus, at the beginning of which he said he had no interest in going back to baseball. Sure, Gamboa led the team through its second-longest losing streak ever, but he approached it with Yoda-like serenity, saying he was more interested in the players learning than winning games (it is worth mentioning that he brought the team within a single game of a playoff berth). And as a 40-year-plus veteran of the game, there is no doubt he imparted this year's squad with lessons to last a lifetime.

Lessons such as: good pitching is no help when you can't score runs; the Staten Island Yankees will always stink; and don't get all distracted just because the front office had you warm up wearing a puffy pirate shirt.

PERSONAL LOAN SALE!

SEPTEMBER 3 - SEPTEMBER 30

FIXED RATES AS LOW AS

7.50% APR*

MCU Personal Loans – a simple solution.

To meet your important or unexpected needs.

Bill consolidation or family expenses

Home improvement projects

Appliances, furniture or household goods

Apply for a Personal Loan today!
1-800-LOAN-MCU | nymcu.org

MCU Strong
Trusted
Growing
MUNICIPAL CREDIT UNION

*APR = Annual Percentage Rate. With approved credit. Rates may be higher based on your creditworthiness. Requires direct deposit or automatic payroll deduction as method of repayment. The Annual Percentage Rate (APR) will increase by 2% during the term of this transaction if you discontinue payment through payroll deduction or direct deposit. Your payments will consist of 60 monthly payments of \$20.05 on each \$1,000 borrowed at 7.50% APR. Rates and terms are subject to change without notice. Certain restrictions apply. Membership is required.

*You know that noise
your heart makes
when you work out?*

IT'S CALLED APPLAUSE.

Think of each beat as your heart's way of cheering you on for staying physically active. Want a standing ovation? Try keeping your diet low in cholesterol and saturated fat too. To learn about other steps you can take toward lowering your risk of heart attack and stroke, visit our web site at www.americanheart.org or call us at 1-800-AHA-USA1.



This space provided as a public service. © 1999, American Heart Association

Advertise your Clinical Studies in New York's largest group of community newspapers.

- Weekly bannered directory
- Ads will also appear in Classifieds & Online

**ASK HOW YOU CAN GET EDITORIAL
COVERAGE OF YOUR STUDY**

**Call Brian Rice
718-260-4537**



THE KINGTASTIC FALL FRENZY SALES EVENT

**0% FINANCING
FOR 72 MONTHS!**

PLUS NO PAYMENTS FOR 90 DAYS!*

BROOKLYNCHRYSLER.COM • 866-906-8338

\$149 PER MO.
LEASE FOR
KINGTASTIC!

NEW 2015
CHRYSLER 200

Heated Seats/Mirrors, Leather Steering Wheel, Remote Start

Auto, 4 Cyl 2.4L, Stk #CA1507, VIN FN504810, MSRP \$25,790. Residual \$13,926.60. Lease for \$149/mo. for 36 mos. @ 10,000 miles/yr. with \$2,995 down. \$0 sec. deposit. \$3,144 due at signing. \$1,000 Conquest Cash included.



THE GREAT AMERICAN
DRIVE EVENT

NEW 2014 JEEP
CHEROKEE LATITUDE

Uconnect w/ Bluetooth, Roof Rails, Spoiler, Fog Lights

\$149 PER MO.
LEASE FOR
KINGTASTIC!

Auto, 4 Cyl 2.4L, Stk #JT14721, VIN EW249546, MSRP \$25,685. Residual \$13,613.05. Lease for \$149/mo. for 36 mos. @ 10,000 miles/yr. with \$2,995 down. \$0 sec. deposit. \$3,144 due at signing. \$1,000 Conquest Cash included.



NEW 2014 JEEP
**GRAND CHEROKEE
LAREDO 4X4**

Power Liftgate, Power Moonroof, Remote Start, Uconnect

\$279 PER MO.
LEASE FOR
KINGTASTIC!

Auto, V6 3.6L, Stk #JT14966, VIN EC546912, MSRP \$39,920. Residual \$23,153.60. Lease for \$279/mo. for 36 mos. @ 10,000 miles/yr. with \$2,995 down. \$0 sec. deposit. \$3,274 due at signing. \$1,000 Conquest Cash included.



2286 Flatbush Ave.
Brooklyn, NY 11234

866-906-8338

BROOKLYNCHRYSLER.COM



*Offer available to qualified buyers on select vehicles. All taxes, tags, and fees not included. Subject to vehicle insurance and availability. See dealer for details. Dept. of Consumer Affairs (DCA) #1435478, Dept. of Motor Vehicles (DMV) #7114167. Offers expire 9/30/14.

CROSSWORD BY STATEPOINT MEDIA, INC.

THEME: AMERICAN FOLKLORE

ACROSS

1. PayPal money
6. "La" precursor
9. Japanese restaurant staple
13. Spasm of pain
14. Romanian money
15. Where one reaction is oxidation and reverse is reduction
16. Portend a good or bad outcome
17. Ash container
18. Anoint
19. *Clyde's crime partner
21. Ubiquitous protein
23. *Do it to create a tunnel like John Henry
24. Discarded cards in cribbage
25. Diminish
28. Jessica of "Dark Angel"
30. Last in octad
35. "Frog and _____ Are Friends"
37. Used to row
39. "And Then _____ Were None"
40. *Paul Bunyan did it to his axe?
41. Double-reed instruments
43. Enthusiasm
44. Montezuma, e.g.
46. Eurozone money
47. Arabic for commander
48. Nervous system component
50. First king of Israelites

52. *Br'er Rabbit is more this than Br'er Fox
53. Sommelier's domain
55. Additionally
57. Drag one's feet
61. *Halloween prowlers
64. Collectible in a cabinet
65. Court
67. Brownish gray
69. Resembling wings
70. "To _____ is human ..."
71. Encourage
72. *Br'er rabbit fought with a sticky one of these
73. Levi's competitor
74. What the defense does?

DOWN

1. Pilot's announcement, acr.
2. Fish of the carp family
3. Mythological ship
4. "The hills are alive with the _____ of music..."
5. Lifting injury
6. Swerve
7. "_____ the land of the free ..."
8. _____ eclipse
9. Waiter's handout
10. Footnote word
11. Musical composition for one, pl.
12. Friends of #29 Down
15. *Br'er trickster

20. Icy hut
22. Rest in state
24. Paint the town red
25. *Revolutionary Allen
26. Drunkard's downfall
27. African language
29. *Blue Ox
31. Clarified butter
32. Steers
33. Hiker's path
34. *Steel-driving man
36. Hunted ruminant
38. Evening in Italy
42. *Where "Uncle Remus" tales took place
45. *Pecos Bill, e.g.
49. Goose egg
51. Plunderer
54. Handrail post
56. "August: _____ County"
57. Healing sign
58. Maui dance
59. Kuwaiti, e.g.
60. Boggy
61. *Blood's partner in Halloween tales
62. Yanks
63. Dalmatian mark
66. Bonanza find
68. Lt.'s inferior, in the Navy

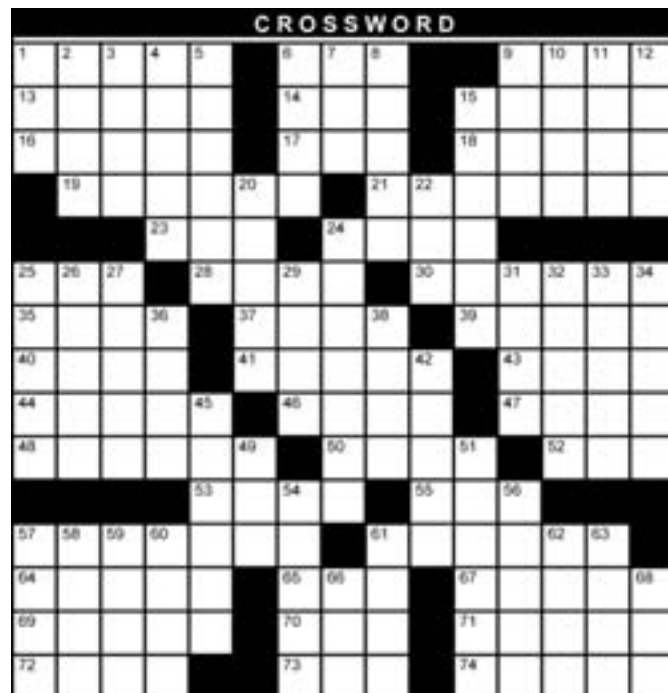

dish
 Make the Switch to Dish Today and Save Up To 50%
 Call Now and Ask How! **1-800-318-5121**
 Call 7 days a week Mon - 11pm EST Promo Code: MB0111 *Offer subject to change based on premium channel availability

Promotional Packages starting at only **\$19.99** mo. for 12 months

FREE PREMIUM MOVIE CHANNELS* For 3 months. **HBO** **ENTERTAINMENT WEEKLY** **STARZ**

Answers in Classified Section

Mets FAN APPRECIATION WEEKEND SEPT. 26-28 vs. HOUSTON ASTROS

FRI. 9/26 – 7:10 PM
FREE SHIRT FRIDAY
presented by Caesars
ALL FANS

SAT. 9/27 – 7:10 PM
AUSTIN MAHONE CONCERT
presented by Duane Reade
AFTER THE GAME

SUN. 9/28 – 1:10 PM
CASEY STENDEL BOBBLEHEAD
presented by SNY & WOR
FIRST 20,000 FANS
2015 MAGNETIC SCHEDULE
presented by Hyundai
ALL FANS

mets.com/tickets

CITI AND ARC DESIGN IS A REGISTERED SERVICE MARK OF CITIGROUP, INC.

ARIES: Mar 21/Apr 20
Aries, your thoughts are spinning and it's pretty difficult for you to get a hold of any one thing. Take a step back and try to clear your head before proceeding.

TAURUS: Apr 21/May 21
Taurus, don't let your nerves get the better of you this week. Find someone who can calm your nerves and help you realize you have nothing to be nervous about.

GEMINI: May 22/Jun 21
Gemini, you have plenty of motivation to get a project started. All you need is some help to get things off the ground. Others will be inspired by your enthusiasm.

CANCER: Jun 22/Jul 22
Cancer, others seem to spend time in the spotlight, but you're more comfortable spending time in the shadows. Make the most of this time for quiet reflection.

LEO: Jul 23/Aug 23
Leo, you may be anxious to try a new hobby this week, but just don't know which direction to go. Get some recommendations from friends about what keeps them busy.

VIRGO: Aug 24/Sept 22
Sometimes it is difficult for you to talk about your feelings, Virgo. You want to present a brave front, but you're only human and should let others in this week.

LIBRA: Sept 23/Oct 23
Libra, staying the course may be a challenge this week. You have too many things pulling you in different directions. But you'll be successful if you can get a foothold in one thing.

SCORPIO: Oct 24/Nov 22
Work associates may not be holding up their end of the deal, Scorpio. You're content to help out once in a while but not take on the work of everyone else.

SAGITTARIUS: Nov 23/Dec 21
Use your charm to win someone over, Sagittarius. This is an influential person who will be good to have in your corner. You never know when you might need a good ally.

CAPRICORN: Dec 22/Jan 20
Capricorn, if certain ideas didn't work in the past, give them another try. All of the components may fall into place this time around, and you'll like the results.

AQUARIUS: Jan 21/Feb 18
Aquarius, the coming weeks may be ideal for some rest and relaxation. Plan for some downtime and make the most of this chance to recharge your batteries.

PISCES: Feb 19/Mar 20
Pisces, expect things to flow much more smoothly this week than they have in recent weeks. You may find you have more free time.

ANCIENT MYSTICAL POWER
Ancient Jamaican Obeah, Voodoo and Black magic Spells. Powerful Occultist, Revenge, Breakup, Court, Reunite, Money, Immigration, Protection, Gambling. 954-251-7969 www.professoraba.com.

JAMAICAN HEALER
Specializes in all forms of work, cross condition, spell break, miracles, power, pain. Cure anything. Results is a must & guaranteed! Call 347-770-9546

CHRISTIAN PSYCHIC MINISTER
Doc Phil Reveals All
Life Readings: Spiritual Awakening, Opens Roads to Love, Career, Finances, Health, Immigrations: Overseas Court Battles, Insurance Cases: Long and Overdue. PUJA & KARMA Offerings
Bishop Phil
"Ordained Christian Reader"
PUJA & KARMA Offerings
Readings by Telephone:
866-915-4804
www.ChristianPsychicMinister.com

Keanu
Powerful Spiritual Life Coach Overpowers voodoo, bad luck, dark roots. Restores happiness. Call enemies by name. Stop suffering! Call Now!
1-214-335-1215

MOTHER DORINA
Results in 24 Hours
Are you facing difficult problems? Health, unhappiness, drinking or afraid in any way?
1907 Inverness Blvd Austin, TX 78745 512-804-0855

UNIQUE SPIRITUALIST & ASTROLOGER
Indian Pandit: Vikram Raj

SUGGESTIONS & SOLUTIONS ON:
Family, children, job, business, money, sickness, love, marriage, depression, jealousy, sexuality, immigration and all personal matter.

QUICK RESULTS • 100% GUARANTEE

EXPERT IN PALM READING, DATE OF BIRTH, FACE READING & HOROSCOPE

REMOVES BLACK MAGIC, OBEAH, EVIL SPIRITS, VODOO, BAD LUCK, CURSE & ALL EVILS

Call: 347-502-9697
121-10 Liberty Ave. Richmond Hill, NY 11419
(Inside Sandy's prvt office)

AFRICAN ADVISOR & SPIRITUALIST
MR SHEIKH SALEEM, 6TH GENERATION OF AFRICAN MEDIUM, CAN HELP YOU OUT OF DESPAIR, SOLVES ALL ISSUES.
Love specialist, Reunite lovers even hopeless cases, Business success, Release from spell, Clear Negativity, Strong Voodoo, Black Magic, Court issues, Family problems, Drugs, Careers, Exams, Gambling, Luck, Protection, Impotency/Sexual Powder & more.
One visit will convince you • Quick Results
By Appt Only • French & English speaking
917-254-6647 • 116TH/7TH AVE
WWW.AFRICANMEDIUM.COM

SISTER DUBONG
Call Now!
Results Immediate
Get Help Now!
347-461-9190
Listen:kingandqueenradio.com

SPIRITUAL ADVICE
Reading, Court Case, Love Life, House Clearance, Uplift & Spiritual Bath and any other problems
Mr. Marshall 917-703-6473
Mr. Green 917-270-3785
Ms. Campbell 718-940-0374

INDIAN ASTROLOGER
PANDIT: KALBHAIRAV BABA JI

Expert in Patra Reading, Open Book, Palm, Reading, Horoscope Photo Reading, Face Reading, Name & Date of Birth. Pandith is Expert in Removing Black Magic, Generation Curses, Black Hearts, Voodoo, Jadoo, Butu, Witchcraft, Obeah, Evil Spirits & Bad Luck.

Are you Suffering from any of the following Problems?

- Black Magic
- Evil Spirits
- Bad Luck
- Reunite Lovers
- Stop Divorce
- Depression
- Psychological
- Business
- Work Problems
- Financial Problems
- Wife & Husband Pro
- Children Mistakes
- Court Cases
- Mortgage
- Drinking Problems
- Health Protection
- House Protection
- Childless Couples
- Sexual Problems
- Lottery
- Success in Life

347-965-9208
104-42 Lefferts Blvd. Liberty Ave. Richmond Hill, NY 11419 (Inside Private House)

AFRICAN PSYCHIC/SPIRITUAL READER, HEALER & CLAIRVOYANT
WITH SPIRITUAL POWERS OF HIS ANCESTRAL MASTER'S SPIRIT. MR. LAMINE is Internationally known & will help with all problems in life. He has helped many celebrities. He can clear negativity, foresee future life events, solves impossible problems. Help bring back loved ones, family problems, depression, substance abuse, impotency/infertility, break black magic, jinx, demonic forces, success in business, exams, career, job & marriage.
African powder for men to satisfy your wife.
Never Gives Failing Advice • Your Pain Is My Responsibility
www.tatajabbie.com
347-539-2163

INDIAN FAMOUS ASTROLOGER
EXPERT IN PALM, FACE & PHOTO READING!
IF YOU HAVE PROBLEMS, I HAVE SOLUTIONS.
Explain By **MATHA: GAYATRI DEVI**

Black Magic • Evil Spirits • Bad Luck • Reunite Lovers
Stop Divorce • Depression • Psychological • Business
Work Problems • Financial Problems • Wife & Husband
Children Mistakes • Court Cases • Mortgage • Drinking
Problems • Health Protection • House Protection
Childless Couples • Sexual Problem • Lottery • Success

LAXMI POOJA, GRAHA POOJA, HOUSE PROTECTION
Specialized in get rid of Generation Curses, Black Magic, Obeah, Witchcraft, Voodoo, etc. OPEN 7 DAYS A WEEK | 10AM to 8PM

347-935-9701
116-09 LIBERTY AVE. RICHMOND HILL, NY 11419 (INSIDE CHOPRA GENERAL STORE)

SERIGNE
Spiritual Reader & Coach
Helps bring back loved ones. Reunite lovers, issues, court cases, success in business, remove bad luck, black magic & witchcraft.
Stop enemy & offer protection!
FAST RESULTS!
917-679-1518 • 646-590-9495
www.spiritualrestore.com

Hougan Maxime
Spiritual Advisor
Haitian Voodoo Priest
Solves Your Problems
Helps with Family Problems, Jobs, Immigration & Legal
Reunites Loved Ones • Saves Your Marriage
Brings Good Luck • Improves Business and More...
718-826-2553 or 917-622-7607

MR SAIDOU
Psychic Readings & Adviser
Bring back loved ones. Stop infidelity in relationships.
Fix domestic, marriage & career problems.
Gain success in business. Remove bad luck, black magic, & witchcraft.
Stop enemies and offer protection.
Call 516-206-8543

Psychic Readings by Natalie
Over 40 years Exp. And God Gifted Ability Past, Present, Future. Names and descriptions of: Positive influences in your life, your soulmate, people who are trying to hurt you. Specializing in ALL Relationship Matters.
Removes Black magic, Evil spirits, Voodoo, Bad Luck & Curses.
718-688-2959

Spiritual Powers
Spell breaker. Reunite loved ones within 3 days. I can help you no matter what the problem may be.
1 FREE QUESTION
Pat: 954-394-1061

READER AND ADVISOR
Mister KHALIFA
International African Spiritual Healer & Clairvoyant
WITH 39 years Exp. Helping people across the world: Africa, USA, France, Australia, UK etc...
Solves all Problems in the Quickest Way:
Bad Influence, Blockage, Unknown Disease, Unhappy Situations, Sexual Problems, Bad Luck, Business Success, Black Magic, Exams, Court Cases, Unhappy Marriage & Relationship.
Do not hesitate to call Mr Khalifa, Results within 7 nights.
646.339.2385 or 646.630.8303

30 Years Experience
PROFESSOR OUMAR
An international spiritual healer, adviser, psychic, medium and astrologer with thirty-nine years experience in inherited from family with a very good reputation of helping people all over the world in Africa, USA, France and Australia. I strongly believe I can solve your problems, bad luck, business matters, black magic, exams, court cases, unhappy marriage, relationship problems. Please do not hesitate to call contact Oumar who can solve all your problems within seven nights.
Your Pain Is My Responsibility
Call 646.239.4298 or 212-316-0567
2166 8th Ave, New York, NY 10026
www.psychicoumar.com

Yes, he's back from the shadow of death, the Jamaican born Obeah man and spiritual case worker.
MR. B
CALL 718-523-1426
Guaranteed success where others fail. Power to help in all walks of life. Calls your friends and enemies by name, without asking you a single word. A visit to this Obeah worker from Jamaica will be of immense value to you.

FOR MORE CARIBBEAN COMMUNITY CLASSIFIEDS, GO TO
WWW.CARIBBEANLIFENEWS.COM

Caribbean community classifieds

To Advertise Call: 718-260-2555

► EMPLOYMENT

To Place Your Ad
Call 718-260-2555

► SALES HELP WANTED

► SALES HELP WANTED

► SALES HELP WANTED

► MEDICAL HELP WANTED

► MEDICAL HELP WANTED

► MEDICAL HELP WANTED

► MEDICAL HELP WANTED

► MEDICAL HELP WANTED

**Now Hiring
PROFESSIONAL SALES AGENTS!!
Excellent Commission Paid**
Big inventory of houses, exclusive listings
Very conducive work environment

Be part of a highly successful team with dedicated, success-driven people to work in a well established Real Estate Office in Queens, NY

**Earn at least
100K a year!**

Experienced and entry-level applicants are welcome to apply. Must be:

- Motivated
- Willing to Learn
- Must have a reliable vehicle

We have been in the business years and guarantee our agents with:

- Hands on mentoring from top real estate agents
- Access to sales leads, top real estate websites, computer and valuable lessons

JOIN OUR TEAM NOW!

Email your resume or call us to apply



246-14 Jericho Turnpike, Floral Park, NY 11001
Phone: 516-502-6828; Fax: 516-502-6831
Email: info@homestyleny.com
www.homestyleny.com

► ADOPTION

Loving married couple longs to adopt newborn. We'll provide a beautiful life, unconditional love, opportunities & security. Expenses paid. Tricia & Don anytime at 1-800-348-1748. https://donandtriciaadopt.shutterfly.com/

► EMPLOYMENT SERVICES

**HOME HEALTH AIDES
IMMEDIATE WORK**
for HHA's with Certificates
+ SIGN-ON BONUS*
Call for schedule of
FREE Training Classes
F/T or P/T Jobs, All Shifts/Locations!
HIGHER PAY & NO DUES
Vacation, Sick Pay, Bonus
*for qualified candidates
able
health care
Bklyn/Queens 718-947-3682
Nassau/Suffolk 516-634-2109
Bronx/Westchstr 914-470-9924

► SALES HELP WANTED

► SALES HELP WANTED

PUBLISHER'S NOTICE

All employment advertised herein is subject to section 296 of the human rights law, which makes it illegal to advertise any preference, limitation or discrimination because of race, color, creed, national origin, disability, marital status, sex, age, sexual orientation, or arrest conviction record, or intention to make any such preference, limitation, or discrimination. Title 29, U.S. Code, Chap 630, excludes the Federal Gov't from the age discrimination provisions. This newspaper will not knowingly accept any advertising for employment which is in violation of the law. Our readers are informed that employment offerings advertised in this newspaper are available on an equal opportunity basis.

► MEDICAL HELP WANTED

Dental Receptionist
Energetic, friendly, cheerful, team-oriented individual with good computer skills to help in our busy Bronx dental office. Experience is preferred.
Call 914-646-5428
Or Fax Resume to: 718-547-8632

CERTIFIED HHA/PCA

Immediate jobs available in all areas of NYC

Excellent Hourly Pay
Paid Time Off
Flexible Hours • Apply Today



Call 718-942-5888

We are an equal opportunity employer dedicated to a drug-free workplace. All training conducted by Bestcare, Inc. through approved NYS DOH Training Program and under contract with MJHS Home Care Solutions

ABLE HEALTH CARE HOME HEALTH AIDES!

EARN UP TO \$34,000/YEAR
FREE Training Classes
Classes Start Sept 8 in Hempstead & White Plains
and Sept 15 in Queens & Islandia
NEW HIGHER PAY RATES

Staff Aide with Car Needed in All Areas
Full Time or Part Time • All Shifts - All Locations

**Higher Pay
(up to \$13.00/hour)**

Health Insurance
Vacation, Sick,
Personal Pay

Immediate work & bonus
for HHA's with certificates



Brooklyn 718-947-3693 Queens 718-947-3673
Nassau 516-634-2117 Suffolk 631-729-2384
Bronx/Westchester 914-470-9929
www.ablehealthcare.com

CABRINI
- CARE AT HOME -
Certified HHAs needed in
Westchester and
New York City Area

Offering various shifts. Immediate placement.
Overtime and Holiday Pay available

Applicants should contact 1-877-893-9223

Certified HHAs or PCAs
Help us make
a difference!

QNS, BKLYN, MANHATTAN, THE BRONX & NASSAU

**MANY CASES AVAILABLE...
IMMEDIATE WORK... TOP \$\$\$**

**\$250
Sign-On
BONUS**
Live-ins only

- Starting at \$10.00/hour*
- \$12.00/hr for Overtime
- \$130.00 Live-In Cases*
- Health Benefits • Wellness Plan
- Free Gift Upon Application

946 McDonald Ave, Bklyn • Ph: 718-972-2929
100-15 Queens Blvd., Forest Hills • Ph: 718-819-3131
391 E. 149th St., Ste 314, Bronx • Ph 718-506-1006



EOE (* for most cases)

Carelink, Inc.
Home Care Agency
Lic. by NYC D.O.H.

**Hiring
Experienced
Certified
HHA's**

For All 5 Boros & Nassau Area

Immediate Hire + Bonus for HHA's w/ Cars

- Health Insurance Available
- 3 Months Home Care Experience a Must

**Call For Appointment
Mon-Fri 10AM-4PM**
718-488-8300 or 516-358-1999
Or email: Carelink1@hotmail.com



► **MEDICAL HELP WANTED**

► **MEDICAL HELP WANTED**

► **MEDICAL HELP WANTED**

► **MEDICAL HELP WANTED**

► **MEDICAL HELP WANTED**

► **MEDICAL HELP WANTED**

► **MEDICAL HELP WANTED**

► **MEDICAL HELP WANTED**

Certified Home Health Aides/
Personal Care Aides

F/T or P/T positions available,
in all 5 boros & Nassau County.

EXCELLENT PAY IMMEDIATE HIRE
Please Call Mon-Fri, 9AM-5PM

BEVERLY'S
HOME HEALTH CARE, INC
718-459-5592

PCAs, HHAs, CNAs NEEDED!

WE ARE HIRING:

- Personal Care Aides (PCAs) • Home Health Aides (HHAs)
- Cert Nursing Assistants (CNAs)

- 2 years experience, Valid INS Work Authorization, 2 professional references needed.

Must pass FBI fingerprint check

Shifts: Daytime, Overnight, 24 hour livein
Live-ins (\$143/ day), Live-out (\$11 per hour)

Paid Vacation and Training



212-726-2549

CNA's & LPN's

With LTC experience needed in
THE BRONX

**GRAND OPENING OF
OUR BRONX OFFICE
OPEN HOUSE DAILY**

10am-3pm

**337 EAST 149th Street
Bronx NY 10451**

**IMMEDIATE ORIENTATIONS
GREAT PAY**

For Brooklyn & Queens Positions
Or info & dir.

Call 718-534-7400

alexis@fsstaffinginc.com

**HHAS HOURLY
& LIVE IN
ASSIGNMENTS
IMMEDIATE
PLACEMENT**

Call Today for
An Interview Tomorrow

212-505-3640

*The Right Person
Makes All The Difference*

SelectCare
home care services

HHAs



**BONUS AVAILABLE!
EXCELLENT PAY & BENEFITS!
PAID TIME OFF,
TRANSIT BENEFITS & MORE!**

Immediate jobs for Certified HHAs
Brooklyn, Bronx, Queens
Chinese, Russian, Spanish and Creole

Scharome Cares, Home Care Agency
1729 E. 12 St., off Kings Hwy, Brooklyn
161-10 Jamaica Ave., Queens

Call Today! Hiring Now!

718-434-0909

**HHAs & PCAs
Live-In & Hourly**

Start Your Career
In Home Care Today!
BETTER REWARDS!

Better JOBS!

- PAID VACATION
- BONUS OPPORTUNITIES
- RECRUITMENT AWARDS
- ADVANCEMENT
- MEDICAL & DENTAL PLAN OPTIONS

**FREE
TRAINING!**

**IMMEDIATE JOBS IN QUEENS & ALL
BOROUGHES & NASSAU COUNTY**

108-12 72nd Ave., Forest Hills, NY 11375
310 Merrick Rd., Rockville Centre, NY 11570
Call us (718) 263-3999 or (516) 763-3260



Better Home Health Care

AGENCY, INC.

www.betterhomecare.com Bilingual a plus

**HHAs, PCAs & CNAs
LIVE-IN ONLY**



- Located North of NYC
- Competitive Wages
- Paid Travel & Vacation
- Monthly Bonuses
- Health Benefits Available • 401K

**Family Owned Business.
Come Meet Our Staff**

Call for Info
800-505-6165



**FOUR SEASONS
HOME HEALTH CARE**

LOOKING FOR

HHAs

Great Salary + Great Benefits!

Requirements:

- HHA certificate
- Valid Photo ID

- Physical Exam form
- Social Security Card
- Two Reference letters



**FOUR SEASONS
HOME HEALTH CARE**
FOUR SEASONS HEALTH CARE SOLUTIONS

Call now:

718-872-4751
1222 East 96th Street,
Brooklyn, NY 11236

Nursing

EOE

**THE BEST SCHOOL
NURSING POSITIONS**

School nursing is great! It offers the chance to work with kids & a team of professionals dedicated to them, get to know your patients as people, and make a difference in YOUR community. But Our Positions Are Better!

- BC HMO with a Rx Plan
- Employer Matched 401K
- Vacation Pay Bonuses
- Unemployment, Workers Comp,
- Disability & Malpractice Insurance
- Employer Matched Medicare /Social Security Contributions

Don't Wait, Call Now!

TemPositions
HEALTH CARE
www.schoolRN.com
(212) 916-0840

Non-school RN positions also avail.

HOME HEALTH AIDES

David York Agency

Now hiring P/T, F/T
Weekday, Weekend,
Live-In, Live-Out.

Top Salaries.

Must be Certified.

Call 718-376-7755



**XINCON
HOME HEALTH CARE**

**FREE HHA TRAINING
MEDICAL, DENTAL, & TRANSIT
BENEFITS + MORE
ATTEND OUR OPEN HOUSE
TUESDAY 11AM**



224 W. 35TH ST, #201, NEW YORK
Hiring Certified HHA/PCA
Immed. Work
Need Home Care? Let Us Help You
Call for Info: 212-560-0615

► EMPLOYMENT

To Place Your Ad
Call 718-260-2555

► MEDICAL HELP WANTED

JZANUS HOME CARE IS HIRING!!!

We are seeking certified Home Health Aides for Full Time, Part Time and LIVE-IN positions!!!!

We offer holiday pay, paid time off, travel reimbursement and refer a friend bonus programs.

We are looking for staff to service our patients in Queens, Manhattan, Brooklyn, Nassau and Suffolk County. Live-in's needed for Suffolk County Cases; \$100 sign on bonus!!!* Call for details.

To find out more information please contact
516-437-4747
For the Suffolk County location please contact
631-207-9242



► MEDICAL HELP WANTED

► MEDICAL HELP WANTED

► HELP WANTED

► HELP WANTED

► HELP WANTED

► HELP WANTED

► HELP WANTED

CAMBA'S Bi-Lingual Case Management JOB FAIR!!!!

FRIDAY, SEPT. 26, 12PM-4PM
Bed-Stuyvesant Multi-Service Center
1958 Fulton St, Brooklyn NY 11233
(Between Ralph & Howard Aves)

Full Time Positions Available

Excellent Benefits & Competitive Salaries
To Be Admitted to the Fair, Applicants Must Have:
At Least 2 Year's Experience in the Social Services field, case management experience preferred. 2 copies of resume. Names & phone numbers of 3 supervisory references.
Bilingual Russian and/or Spanish

DRIVERS

Premier Paratransit is seeking Drivers with NYS CDL Class C with Passenger Endorsement

COME IN FOR APPLICATION
940 REMSEN AVENUE
(bet Ave D/ Foster Ave- Brooklyn)

Mon-Fri 8AM-7PM
Sat-Sun 8AM-4PM

MECHANIC

Wanted for busy Brooklyn tool rental store. Gas Engines, Power Tools & Hydraulic machines. MUST have experience in TOOL RENTAL Business
Call 917-304-3888

School Bus Attendants/Escorts

To help Wheel Children on their School Bus. Must be able to move Wheel Chairs. All Brooklyn Routes.
\$9.40 per hour
Individual health coverage.

Apply in person:
Monday-Friday 9:30^{AM} to 4^{PM}
5015 Bay Pkwy, Brooklyn NY 11230
(corner Bay Pkwy & McDonald Ave)

► HELP WANTED

► HELP WANTED

Office Worker FT/PT

Good phone voice. Knowledge of computers necessary
Nice work environment
Queens location
718-523-9600

The following positions are available working with developmentally disabled adults in Group Home in Canarsie, Brooklyn:

Direct Care Counselors Needed- Experience Pref'd

Drivers Needed

Interested applicants please fax resume to 718-934-2669 or email resume to Karen@asbm.org

PLUMBERS, BACKHOE OPERATORS

Plumbing position requires minimum of 3 years Exp. Requirements are Jobbing In & Out plus Alterations.
CALL MATTHEW (917) 731-6208 (718) 649-0317

TRUCK DRIVERS

Must Drive Stick Shift CDL-B, F/T Mon.-Fri. Bakery Ingredients
Call Fay
718-381-0600 or 718-417-7596
or Fax 718-456-7699
call after 10am

HEALTH CARE AGENCY NOW HIRING!!!

RN CASE MANAGERS & RN SUPERVISORS, RN's, LPN's IN NYC, BK, BX & QUEENS
SOUTH NJ: LPN'S, CNA'S W/ LTC EXP.

SPECIAL NEED FOR IV CERTIFIED RN'S RN'S WITH 2+ YRS HOME CARE EXP (A MUST)

THOSE W/ LTC EXP ENCOURAGED TO APPLY FOR MORE INFO (INCLUDING PAY)
CALL: 718.834-1911 OR
EMAIL: HR@SAMARITANSERVICES.COM
We are a Christian owned organization serving all needs.

► HELP WANTED

\$8,000 COMPENSATION. EGG DONORS NEEDED. Women 21-31. Help Couples Become Families using Physicians from the BEST DOCTOR'S LIST. Personalized Care. 100% Confidential. 1-877-9-DONATE; 1-877-936-6283; www.longislandivf.com

ALL HOUSEKEEPERS

TAMI'S AGENCY International Housekeepers

Nannies, Housekeepers, Companions
Live-in/Live-out Full time/Part time

We have jobs! Fast Placement!

Brooklyn • Manhattan • Queens
Bronx • Nassau

718-520-1313
516-945-9520

109-17 72nd Rd, Ste 2F, Forest Hills NY
Directions: E/F train to 71st Ave/Continental Ave
DCA License #1109974

www.TamisAgency.com

► HELP WANTED

► HELP WANTED

► HELP WANTED

► HELP WANTED

► SECURITY HELP WANTED

SECURITY GUARDS WANTED

Must have NYS Security Guard License + 8 & 16 Hour Certificates, NYS ID & Social Security card. Fire Guards Also Needed. Must Wear Business Attire.

By Appointment Only
Call 212-283-8200

► SECURITY HELP WANTED

NYS APPROVED SECURITY TRAINING
816 Annual-In-Service
Nr The Barclays Arena
540 Atlantic Ave, Bklyn
Near 2 3 4 5 B D N Q R & LIRR
Tel: 718.855.0500
web: www.thealmgroup.com

► DOMESTIC HELP WANTED

NANNIES & HOUSEKEEPERS

Immediate Employment on Long Island. F/T or P/T
Experience, References, & Legal Papers a Must! Live in/out! No Fee!!

ABSOLUTE BEST CARE

Highest Pay!!!

CALL 516-802-3780
OR 631-486-4594

HOME HEALTH AIDES IMMEDIATE WORK

for IHA's with Certificates + SIGN-ON BONUS*
Call for schedule of FREE Training Classes
F/T or P/T Jobs, All Shifts/Locations!
HIGHER PAY & NO DUES
Vacation, Sick Pay, Bonus
*for qualified candidates

Bklyn/Queens 718-947-3682
Nassau/Suffolk 516-634-2109
Bronx/Westchstr 914-470-9924

► HELP WANTED

Junior Mechanic FULL-TIME

Good opportunity!
Knowledge of Heating a Plus.
Driver's license req.
718-235-4091

IMMEDIATE HIRE

Drivers F/T & P/T

Monday - Friday
8AM - 2PM

STARTING SALARY \$14hr
F/T Driver Sign On Bonus

- Bring license & Social Security card.
- Apply in Person.
- Will train with class D license.

Must be at least 21 yrs old w/valid NYS Driver's license for at least 3 yrs. CDL (Class C) with/pass endorsement necessary.
New & Experienced Drivers Welcome.

Paid 2-weeks training. Annual bonuses & overtime.
Union benefits including medical, dental for you and your family, life insurance, 401(k), paid holidays, vacation & personal days.

EMPIRE PARATRANSIT CORP

We are conveniently located near the L train.
880 ALABAMA AVE., BROOKLYN, NY 11207
(Corner of Wortman)

CALL: 718-272-2060 x133

► HELP WANTED

► HELP WANTED

► EDUCATION SERVICE

► JOB INFORMATION

► AUCTIONS

► LEGAL

► LEGAL

► LEGAL

GREENHOUSE ECO-CLEANING
is Eco-Friendly Cleaning Company based in Brooklyn, NY.
We have job openings for a Cleaning Specialist.
Requirements are legally permitted to work in the U.S. and has 1-2 years cleaning experience. We want a Positive attitude with open availability to work. We are looking to grow a team that loves to clean for a living. Starting at \$10 per hour.
APPLY online at
greenhouseecocleaning.com/careers



All 5 Boros Intensive Review
Mon thru Thur. Morn/ Eves
New GED, GMAT, MCAT, GRE, SATs, Regents, LAST EXCELLENT RESULTS!!
Sm. Student Faculty Ratio
GED: 4 WEEKS \$150
Evenings Mon, Wed 7-9PM
Mon thru Thur- 8-10PM
6 WEEKS Program
Sun- 3- 6PM, Sat- 9-12PM
& 1:30-4:30PM
Add'l Prog For Students Who Have Difficulty w/Science/ Math. LSAT. High School & College Prep in All Subjects. **PROF. DALEY: 718-369-0704**

Leticia James Warns Consumers About Classified Ads
Toll numbers may be a direct line to trouble.
Classified ads are intended to help people by facilitating communication and advertising available services; however, some of the hotlines & service numbers in classifieds actually hurt the people who rely on them by cheating them of their hard-earned dollars. "Most newspapers print a disclaimer in their classified ad section to warn readers about numbers that are a direct line to trouble. Any number starting with 900, 540, 595 or 871 charges a fee beyond a local call. In some instances, ads initially advertise calls to a local number, but then direct callers to a second number starting with one of the paid exchanges. "Consumers must also question the legitimacy of vague classifieds because they too could be a scam. Before responding to an ad, consumers should verify the source of all information & always be wary about sending money or signing a contract with an unknown party."
Office of the Public Advocate

Buy or sell at AARauc-tions.com. Contents of homes, businesses, vehicles and real estate. Bid NOW! AARauc-tions.com
Lights, Camera, Auction. No longer the best kept secret.

NOTICE OF FORMATION of limited liability company (LLC). Name: MDR COMMUNICATIONS + EVENTS LLC. Articles of Organization filed with Secretary of State of New York (SSNY) on 05/28/2014. Office location: New York County. SSNY designated as agent of LLC upon whom process against it may be served. SSNY shall mail copy of process to: MARIA ROMERO 601 WEST 135 STREET #6A NEW YORK, NY 10031. Purpose: any lawful purpose.

York Block 4055, Lot 9 will be sold, in one parcel at public auction on October, 2, 2014, at 2:30 P.M., at the Kings County Supreme Courthouse, 360 Adams Street, Courtroom 224, Brooklyn, New York, the premises described in said Order and in Exhibit A annexed hereto. The premises shall be sold "As Is" subject to any state of facts an accurate survey would show, and to covenants, restrictions and easements, if any, of record affecting said premises and any violations thereof, and to the zoning regulations and ordinances of the city, town or village in which said mortgaged premises lies and any violations thereof. The premises shall be sold free and clear of all liens, encumbrances, claims, or other interests encumbering the Real Property with said liens, encumbrances, claims, or interests being transferred to the proceeds of sale in respective priority of the liens as they existed as of the Petition date. The sale would be subject to final confirmation by the Bankruptcy Court of the Western District of North Carolina and subject to a

\$2,500.00 payment to be paid to the Trustee for the benefit of the estate. Dated: August 19, 2014
Mineola, New York
Cohn & Roth Attorney for Trustee 100 East Old Country Road Suite 28 Mineola, New York 11501 (516) 747-3030
"EXHIBIT A"
ALL that certain plot, piece or parcel of land, with the buildings and improvements thereon erected, situate, lying and being in the Borough of Brooklyn, County of Kings, City and State of New York, bounded and described as follows:
Beginning at a point on the easterly side of Atkins Avenue, 225 ft. southerly from the corner formed by the intersection of the easterly side of Atkins Avenue and the southerly side of Sutter Avenue; RUNNING THENCE Easterly parallel with Sutter Avenue and part of the distance through a party wall, 100ft; THENCE Southerly parallel with Atkins Avenue, 25 ft.; THENCE Westerly parallel with Sutter Avenue, 100 ft. to the easterly side of Atkins Avenue; THENCE Northerly along the easterly side of Atkins Avenue, 25 feet to the point or place of BEGINNING.

► HELP WANTED

► HELP WANTED

► HELP WANTED

LIVE-IN COMPANIONS WANTED THROUGHOUT CONNECTICUT
We are looking for responsible individuals with life experience who enjoy working with the elderly and making a difference in someone's life.

- Both Full-time and temporary positions available in locations throughout CT
- Flexibility based on your availability and skill-set
- Medical (80% Company Paid), Dental and 401K benefits
- Competitive wages, merit-based bonuses, paid training, recognition and incentive programs

For employment opportunities today apply online at:
www.caregiverjobsct.com
Or call us at: **1-888-844-4442**
CT DCP HCA 0000101

► TUTORS

99% PASSING RATE
Improvement Guaranteed
Licensed Math Instructor
All levels Maths, incl GED, NY State Regents, College courses etc. Individualized attention. **Fax service for Exams & Home Work edmon101@aol.com 1-347-267-7385**

PROFESSIONAL Tutoring Service
College Prep. 5 Boros
All SUBJECTS Available
Excellent Results!
REGENTS SAT1 & SAT2 Exams AP & ENTRANCE Exams. MCAT, GRE, GMAT Exams - LAST Cuny Exam
Intensive GED & ESL Day Classes Start 6/09
Call Prof. Daley 718-369-0704

► MERCHANDISE WANTED

CASH BUYER! Buying ALL Gold & Silver Coins, Stamps, Paper Money, Comic Books, Entire Collections, Estates. Travel to your home. Call Marc in NY: 1-800-959-3419

Wanted Old Calypso & Reggae Records
33's, 45's, 78's. Calypso from 1940's- 1960's. Reggae from 1960's -mid 70's. African, Guyanan, Haitian from 1940's-1970's. Also: Blues, Gospel, Soul, Middle Eastern & Jazz
Charlie 516-612-2009

► FURNITURE

Beautiful Solid Cherrywood Bedroom Set
New in box w/warranty
Original \$3,000+ Sells for \$899 718-499-4499

WHY PAY MORE? CALL NOW!
To Advertise Here
Call 718-260-2555

► HELP WANTED

► HELP WANTED

CONTINUUM SECURITY CONSULTANTS INC.
Jump Start Your Security Career!

8 Hour Pre-Assignment	\$40
16 Hour on the Job	\$80
8 Hour Renewal	\$40
Fire Guard Cert.	\$50
CPR/First Aid/AED	\$100

CALL MOE 347-691-5487
152-32 Rockaway Blvd. Suite 200/201
Jamaica, Queens NY 11434

WAREHOUSE HELPERS
Part Time/Evening Hours. Must be familiar with warehouse equipment
Call Faye or Ozzie after 4:00PM
718-381-0601
718-417-7596

► JOB INFORMATION

AIRLINE CAREERS begin here - Get FAA approved Aviation Maintenance Technician training. Financial aid for qualified students. Job placement assistance. Call AIM 866-296-7093

I	S	A	A	C	Y	O	U	O	R	A	L	
S	H	I	R	R	E	E	N	O	P	E	R	A
M	O	N	E	Y	A	R	P	P	A	N	I	C
P	U	N	I	S	H	E	Y	E	H	O	L	E
A	N	T	A	G	A	R						
A	G	O	G	E	M	S	W	A	T	S	O	N
D	R	U	M	M	E	S	A	S	A	M	B	A
Y	E	T	I	S	L	A	N	G	L	I	E	S
T	E	E	N	S	T	U	T	U	E	R	S	T
A	D	R	I	A	N	L	I	M	N	K	E	Y
L	A	S	T	B	A	A						
Y	O	U	C	A	N	T	P	O	P	G	U	N
E	R	R	O	R	E	E	L	A	R	S	O	N
W	E	A	R	Y	E	R	A	L	E	P	T	A
S	O	L	E	D	R	Y	M	E	S	S	Y	

Thinking of Selling Your Vehicle?
Check Out Our Automotive Section
To Advertise Call 718-260-2555

LEARN TO EARN!

EDUCATION & CAREER TRAINING

HHA/ PCA FREE Training Classes

Train to become a NYS Certified Home Health Aide in just 16 days
Call today to register for upcoming classes!
Jobs available upon successful completion
Excellent Pay and Flexible Hours



Call 718-942-5888

We are an equal opportunity employer dedicated to a drug-free workplace.
All training conducted by Bestcare, Inc. through approved NYS DOH Training Program and under contract with MJHS Home Care Solutions

FT/PT DRIVERS WANTED For Bronx Based Access-A-Ride Company

- Must be at least 21 Years Old
- Clean NYS CDL Drivers License
- Type C with Passenger Endorsement Required
- Knowledge of Five Boroughs a Plus



We Offer: Paid Training Upon Course Completion and Start In Revenue Service, Free CDL Training with Immediate Hire, Paid Sick and Personal Days, Paid Holidays, Two Weeks Paid Vacation After One Year, Medical Benefits, Competitive Salary, Safe Driving and Attendance Incentives.

Applicants Must Apply in Person at: 2383 Blackrock Ave., Bronx, NY 10462
Contact: Roger Izzì at **718-828-2472** ext 201
or rizzi@cbftrans.com 9:00 am - 2:00 pm

BRAMSON ORT COLLEGE www.BramsonORT.edu

Apply Today
877-479-0705

Our mission is education.

Our focus is your career.

- Paralegal
- Medical Assistant
- Graphic and Game Design
- Electronics Technology
- Business Management
- Computer Technology



- Accounting
- Administrative Assistant
- Renewable Energy
- Computer Programming
- Pharmacy Technician
- CADD & HVAC and more!

Affordable Tuition • Financial Aid Available • Flexible Class Schedules
National & Industry Exam Prep • Job Placement Services • Career Internships

UNIVERSAL EMERGENCY CARE TRAINING INC. emslife.com



Become a
Professional
Get the Training
Days, Evenings, Weekend
Classes

EMT, ACLS, PALS, First Aid, CPR, AED and EKG



Accepting
Registration
for our
Fall EMT
program

RN, LPN Review, R.N.Clinical Workshop

196 State Street Brooklyn New York 11201

Call for more information **718-855-7366**

EMPLOYMENT OPPORTUNITY IN NURSING HOMES, HOSPITALS, MEDICAL OFFICES/CLINICS & PATIENTS' HOMES

Earn A Diploma and Skills:
Train To Become A

- HHA HOME HEALTH AIDE
(English & Chinese)
- CNA-NURSE AIDE
(State Board on Premises)
- EKG TECHNICIAN
- PHLEBOTOMY TECH
- PATIENT CARE TECHNICIAN
(nurse technician)



- No Experience Necessary • Payment Plans Available
- We Accept All Major Credit Cards

BULKAN'S EDUCATIONAL INSTITUTE

Licensed by New York State Education Department

1467 Nostrand Ave, 2nd Fl. Bklyn, NY 11226 718-624-7800

Corner of Church & Nostrand Aves. above Dunkin Donuts



BRIC

**BOOST YOUR
RESUME.
INCITE YOUR
CAREER**

Gain the media skills that will amplify your professional repertoire. Take low-cost classes in video production, marketing, and more.

BRICartsmedia.org/bme
718.683.5645

BRIC House
647 Fulton Street
Brooklyn, NY 11217

Access Careers
Brooklyn
www.AccessCareers.Edu

Call Now
866-488-6510

Are You HHA? Upgrade to PCT

- ◆ Medical Assistant
- ◆ Physical Therapy Aide
- ◆ Dental Assistant
- ◆ Computer Programming
- ◆ Nurse Aide (CNA)
- ◆ Computer Networking
- ◆ EKG Phlebotomy
- ◆ Pharmacy Technician
- ◆ Patient Care Tech
- ◆ Medical Billing & Coding

- * Morning, Evening & Weekend Classes (4 to 6 Weeks)
- * We Accept Vouchers (Workforce, ACCES-VR, HRA)
- * Onsite State & National Examination Center
- * Outstanding Job Placement Assistance
- * Close to Subway 2, 3, 4, 5, A, C, G, Q, D, E, F, at Hoyt St.

NO HS DIPLOMA OR GED REQUIRED
Licensed by NYBED & Accredited by GDE

All Medical Assistant Com. Programming & Networking Students will receive FREE MONTHLY UNLIMITED METROCARD up to 9 Months.

CAREER CHOICES ACADEMY, INC.

139 Fulton Street, Suite 616,
New York, NY, 10038

The Right Choice for a Bright Future!

(212) 227-9222 / (646) 421-9976

OPEN HOUSE

Call for Schedule

Medical Administrative Assistant including Internship • Medical Insurance with Billing/Coding includes ICD-10 • Intro to Computers, MS Word
Licensed by the NYS Education Department

www.careerchoicesacademy.org

Conveniently located in Downtown Manhattan, a block from WTC. Accessible by Train: 2, 3, 4, 5, A, C, E, J, Z, R, Path

ENTER A CAREER IN HEALTH CARE

COMPLETE COURSES IN 4 TO 8 WEEKS

- Nurse's Aide Training 5 to 6 Weeks.....\$685
- Patient Care Tech (PCT), (PCA) Nurse Tech.....\$690
- HHA & PCA.....*Creole/French Students Welcome*.....\$650
- Phlebotomy & EKG Training.....\$690
- Having Difficulty Passing the Nurse Aide State Board Exam? TRY OUR 2 WEEK REVIEW COURSE.....\$2,500
- PHARMACY TECH 8 WEEKS.....\$900
- Nurse Aides Can Become Home Health Aides in 10 Days...\$550

Morning, Evening & Weekend Classes
\$50 REGISTRATION FEE
NO HS DIPLOMA OR GED REQUIRED

DAISLEY II INSTITUTE, INC

495 Flatbush Ave. • 2nd Fl. Brooklyn
(bet. Lefferts & Empire Blvd.)
718-467-8497

HHA/CNA/ EKG/ Phlebotomy

Job Placement Assistance Available

Start Dates for Next Classes

- HHA Day 10/16/14
- CPR Wk/End 09/27/14
- CNA Day 11/03/14
- (Wk/End) 10/11/14

Pre-Registration Going On Now
State Board Exam on Premises for CNA Class
Call Today To Register-Class Fills Quickly

718-206-1750

www.NYHC.com

New York Institute of Healthcare Careers, Inc.
161-10 Jamaica Avenue, 3rd Fl. Jamaica, NY 11432
Lic. by NYSED



BABY NURSE CLASS

- Best Newborn Care class in the industry!
- Hospital Instructors & Full Certification!
- Includes Infant CPR

Become a Baby Nurse Today! **\$300**

ABSOLUTE BEST CARE, INC.

Get your Certificate in one day

Baby Nurse is non-medical & known as a Newborn Care Specialist

212-481-5705 • 732-972-4090

CNA/HHA Training

Day & Evening Classes Available REGISTER TODAY!
2,4 & 6 Week Courses

Next Classes Start Soon
CPR, EKG & Phlebotomy Classes

HHA \$325
SPECIAL \$750 \$650! Everyone is Welcome
Registration Fee Included

Miss Kim

Licensed by NYS Education Department
Payment Plans & Workforce Voucher Accepted

\$10 Off With Ad

718-778-6120

Kareful & Karefree Training School Inc.
Bklyn Loc. 2440 Fulton St. 2nd Floor

To
advertise
your
**SCHOOL or
EDUCATION
PROGRAM**
call
718.260.2555

LEARN TO EARN!

EDUCATION & CAREER TRAINING

Build something that leads to even brighter horizons:
Your Career.

There is still time to register for the fall 2014 semester!

Fall classes begin Monday, September 8th



To find out more information, call IDC today!
718-855-3661 - www.idc.edu
141 Willoughby Street, Brooklyn, NY 11201

Call 718-260-2555 To Advertise Here

We take care of your health

FCI can make it easy to change your life with a new career!

Choose from the following fields...

- Medical Office Assistant - Medical Office Assistant with CSD
- Pharmacy Technician - Certified Nursing Assistant
- Phlebotomy and EKG - Medical Billing and Coding
- Day and Evening Classes Offered

Students enrolled in our Medical Office Assistant or Pharmacy Technician course are eligible to participate in The Yonkers Pell Grant Program as well as the NYS Tutor Assistance program. All graduates will be offered Full Job Placement Assistance.

Call us 718-535-3333

BROOKLYN:
5203 5th Avenue
Brooklyn, New York 11220
Phone: (718) 535-3333

LONG ISLAND:
91 North Franklin Street
Hempstead, New York 11550
Phone: (516) 481-6444

Franklin Career

All Medical Office Assistance Students will receive all their text books on a Brand New iPad... yours to keep upon graduation.

► R.E., SERV.

PUBLISHER'S NOTICE

All real estate advertised herein is subject to the Federal Fair Housing Act, which makes it illegal to advertise "any preference, limitation or discrimination because of race, color, religion, sex, handicap, familial status, sexual orientation or national origin, or intention to make any such preference, limitation or discrimination." We will not knowingly accept any advertising for real estate which is in violation of the law. All persons are hereby informed that all dwellings advertised are available on an equal opportunity basis.



► BROOKLYN APTS UNFURN

► BROOKLYN APTS UNFURN

TRENDING NOW:

SPRING CREEK TOWERS

One or call for an application: 718-642-7108

ONE BEDRM From \$1,100

THREE BEDRMS From \$1,600

TWO BEDRMS From \$1,350

Visit our website for more details: www.springcreektowers.com

© 2014 Spring Creek Towers, LLC. All rights reserved. See Us & We'll include. Must be income qualified. Approved by FICD.

BROOKLYN COLLEGE AREA
Large, Beautiful, Reno'd 1BR Apt, Nr Shopping, Transp & The Junction, \$969/month.
SEE SUPER, A10
3201 GLENWOOD RD
718-662-1490

Flatbush/Lefferts
Spacious 2BR, 2nd Fl. Private home. Gas incl. \$1500. No Pets. Credit check w/ fee. Ref's req.
M C Realty
718-484-8582

OLD MILL BASIN
4 Rooms, 2 Bdrms, Renovated, 2 Baths, Hardw Flrs, New Kitchen & Bath, Backyard, Nice Block, \$1600/mo Incl Heat & Gas
Call Ben Lic. RE Bkr
718-266-9700 or 347-866-5619

► BROOKLYN ROOM UNFURN

CANARSIE: Large Unfurn rooms. Close to Transp, shops. NO: pets/smoking. \$775/mo (1st month rent & security). **OWNER:** 347-204-0781

► BROOKLYN ROOM FURN

BROWNSVILLE. Large furnished room, share kitchen and bath. Near shopping and transportation. No Pets, Non-Smoking. Owner 347-683-1566

► BROOKLYN HOUSE FOR SALE

EAST NY, 2 fam, 3BR dup over 1BR rental, parking + yard! Call for more details. Welcome Home Realty 718-513-0240

► BROOKLYN OPEN HOUSE

EAST FLATBUSH OPEN HOUSE
SUN. 9/14 From 1-4 PM
738 EAST 51ST ST.
(Clarendon Rd & Ave D)

Beautiful det brick 1 family. Formal DR, EIK & 3BRs + large attic. 11' ceilings, stained glass windows & parquet flrs thruout. Fin bsmt w/ tall ceilings. Garage & security gates. Price Reduced \$499,000
BEST SELLER
#1 PROPERTIES LLC
718-646-6900



East Flatbush
Saturday 12-3 pm
1062 Willmohr St.

(btwn. East 93 and East 94th St.)
Corner two family brick offering a large two bedroom apt. over a 1BR apt. Built-in garage, private driveway, front porch, rear deck to backyard, fairly new roof, all new windows, new sidewalks, new steps. Priced for quick sale. Near Brookdale Hospital. Asking Low \$400's. ID# 06263
How to Sell Realty
718-377-3795

► QUEENS APTS UNFURN

JAMAICA, 6 room apt, 3BRs, full eat-in kitchen, 2 full baths, excellent cond, hardwood floors, \$1700 + utilities. Owner 917-836-5774

► QUEENS ROOM UNFURN

QUEENS: Furn/Unfurn Rooms Available, Shared Kitchen & Bath. **OWNER:** 516-415-2266

► FLORIDA HOUSE FOR SALE

FLORIDA HOMES & CONDOS

NOW STARTING AT \$49,900 NO QUALIFYING

Call About Our Fly & Buy Program

No Credit? Bad Credit? NO PROBLEM!

1-855-727-2683
Florida Properties of Ocala, Inc.

► CARIBBEAN HOUSE FOR SALE



AMAZING Recently Constructed Townhouse For Sale in Trinidad. Located behind the Arima Hospital and Velodrome, it is the ideal location. 1 min to downtown Arima, 3 mins to Hghwy. 3 BR, 2.5 Baths, Den, Kit, Living & Dining rm, A/C, Hot & Cold, 1,600 sqft with residents gym, video intercom & electric gates. **TTD: \$1.5M/ USD: \$245,000**
347-593-1558
DNECKLES@GMAIL.COM

► QUEENS ROOMS FURN

AVERNE, QNS: Large bedrooms available. **REASONABLE PRICED.** **OWNER:** 917-806-4302

► VACATION HOME FOR RENT

OCEAN CITY, MARYLAND. Best selection of affordable rentals. Full/ partial weeks. Call for FREE brochure. Open daily. Holiday Real Estate. 1-800-638-2102. Online reservations: www.holidayoc.com

► NYS LOTS & ACREAGE

BANK ORDERED SALE. Up to 10 acres from \$59,900. Beautiful Bethel NY. Near Woodstock site. 85 miles from Manhattan. Assorted hardwoods, approved building site, underground utilities, across from lake. Walk to Performing Arts Center, Financing. Call (877)836-1820.

CONTRACT FAILED! 6 acres- Stream- \$26,900 Views, apple trees, pines, gorgeous stream, 3 hours from NY City! Terms avail! Discounts for cash! 888-905-8847
NewYorkLandandLakes.com

REAL ESTATE CLOSINGS Buy/Sell. Expd Attorney, Real Estate Broker, ESTATES/ CRIMINAL MATTERS Richard H. Lovell, P.C. 107-48 Cross Bay, Ozone Park, NY 11417 718 835-9300. www.LovellLawnewyork.com

► HANDYMAN

APPLIANCE REPAIR SERVICE

CASC Corp.

Appliance Sick? Call us Quick!

- Stoves • Ovens • Washers • Dryers
 - Dishwashers
 - Air Conditioners • Deep Fryers • Ice Makers
- We Service All Restaurant Equipment
Expert Boiler Repairs

"Don't Throw it Away, We Will Fix it Today"

All Work Guaranteed
SAM 718-773-1111 • 917-287-5027

► CARIBBEAN HOUSE FOR SALE

AMAZING Recently Constructed Townhouse For Sale in Trinidad. Located behind the Arima Hospital and Velodrome, it is the ideal location. 1 min to downtown Arima, 3 mins to Hghwy. 3 BR, 2.5 Baths, Den, Kit, Living & Dining rm, A/C, Hot & Cold, 1,600 sqft with residents gym, video intercom & electric gates. **TTD: \$1.5M/ USD: \$245,000**
347-593-1558
DNECKLES@GMAIL.COM

► PENNSYLVANIA HOUSE FOR SALE

HOUSE FOR SALE
POCONOS Pennsylvania
1/2 Hour to Historic Milford
3 Bdrms, Eat-In Kitch, Large Living Room, 2 Full Bathrooms, Lrg Rec Rm, Garage, Community Pool.
Call Owner 718-807-7222

► ELECTRIC UTILITY SERVICES

Want to save \$ on your electric bill? NRG Home Solar offers free installation if you qualify. Call 888-685-0860 or visit nrghomesolar.com

► AUTOS FOR SALE

2002 Cadillac. 4 Dr Sedan. Color: Champagne. Very Good Cond. **\$5,000 Neg. OWNER: 718-946-2856 or 917-597-9916**

► AUTOS WANTED

Donate your car to Wheels For Wishes, benefiting Make-A-Wish. We offer free towing and your donation is 100% tax deductible. Call (855) 376-9474

► HANDYMAN

► SERV. & AUTO

► LEGAL DIRECTORY

► AUTOS WANTED | ► AUTOS WANTED

DONATE YOUR CAR

Wheels For Wishes benefiting
MAKE-A-WISH.

Metro New York and Western New York
100% Tax Deductible

*Free Vehicle/Boat Pickup ANYWHERE
*We Accept All Vehicles Running or Not

WheelsForWishes.org Call: (917) 336-1254

► ELECTRIC UTILITY SERVICES | ► ELECTRIC UTILITY SERVICES

Looking for Homeowners to Qualify for a FREE Home Solar Installation

- Own Your Own Home
- Have a Southerly-Facing Roof
- Little to No Shading
- Pay an Electric Bill

The U.S. Government and your State have financial incentives that may provide homeowners the opportunity to supplement your electric provider with solar power.

NRG Home Solar is now qualifying homes for a FREE home solar installation. Call or go online today to see if your home qualifies.

888-359-7288
NRGHomeSolar.com

NRG Home Solar offers you the option to go solar for as little as \$0 down or you can lower your monthly lease payment with a down payment. Consult your solar specialist to determine your eligibility. Financing terms, pricing and savings vary based on customer credit, system size, utility rates and available rebates and incentives. System performance subject to several factors including location, roof and shading. Savings on total electricity costs not guaranteed. NRG Home Solar is a service mark of NRG Energy, Inc. © 2014 NRG Home Solar. All rights reserved.

nrg Home SOLAR

HIC NYC 1427914, HIC Yorkers NY 5872, HIC Nassau County NY #240572000, HIC Suffolk County NY 55096H, HIC Westchester County NY W24767012, HIC Rockland County NY #1153840000

Save Money

On Everything From Cars to Guitars

By Shopping In Our Classifieds

ATTORNEY

Law Offices of Marina Shepelsky P.C.

Immigration and Family Law

Green Cards • US Citizenship • Divorces
Child Support • Visitation
2306 CONEY ISLAND AVE. • BROOKLYN, NY 11223
Tel. **718-769-6352**
www.shepelskylaw.com

We specialize in difficult cases, prior attorney mistakes, deportation, court proceedings
Serving the New York community since 2002

ATTORNEY

SOLVE JAMAICAN LEGAL ISSUES IN NEW YORK AT NO EXTRA COST

MEET HERE™ **DONE HERE™**

ALIMI BANJOKO
Registered Foreign Legal Consultant
NY, CA, & ONTARIO
BARRISTER-England & Wales & ATTORNEY-AT-LAW- Jamaica

718-385-5300
PROPERTY * BUSINESS * PROBATE
* DIVORCE * PERSONAL INJURY
OFFICE: 5306 Church Avenue, Brooklyn, New York 11203
Website: www.banjokomcglashanlaw.com
Email: ab@banjokomcglashanlaw.com

ATTORNEY

JOAN FORRESTER ATTORNEY AT LAW

Over 15 Years of Legal Experience
(also a graduate of the University of the West Indies)

Real Estate • Immigration • Family Law
• Divorce • Criminal Matters (inc DWI & Domestic Violence) • Bankruptcy • Wills & Probate Matters of Estate • Landlord & Tenant • Adoptions

Tel: 718-658-3200
145-11 Jamaica Ave, Jamaica, NY 11435

ATTORNEY

DWI • ASSAULT • DRUGS

FREE Consultation • All 5 Boros
CRIMINAL DEFENSE ATTORNEY
Former NYC Prosecutor

KNOW YOUR RIGHTS!

Law Offices of Lowell J. Sidney
888-222-0513
www.sidneylaw.com

ATTORNEY



Immigration problem?
You need an experienced attorney who can protect your rights honestly and professionally.

IMMIGRATION ATTORNEY
CHRISTI M. GELO, ESQ.

135-24 Hillside Avenue
Richmond Hill, NY 11418
(718) 770-7301

- Deportation/ Removal Proceedings
- Family and Employment Based Petitions
- Political Asylum
- 24 Hour Emergency Service for Detained Individuals
- Reasonable fees and special fees for victims of domestic violence*
- Other practice areas include Bankruptcy, Divorce, Family Law and civil litigation.

FREE CONSULTATION | LATE EVENING & WEEKEND APPOINTMENTS | DEDICATED TO INTEGRITY, HONESTY & FAIRNESS

* Special fees for victims of domestic violence filing petitions under the Violence Against Woman Act

ATTORNEY

GET JUSTICE!

Personal Injuries, Police Brutality
Construction & Auto Accidents
Civil & Commercial Litigation
Medical Malpractice
Wills, Trusts and Estates

CALL TODAY FOR YOUR FREE CONSULTATION!!

Law Office of Philip W. Coleman, LLC
881 Gerard Ave., Suite 4
Bronx, New York 10452
Call Toll Free! 800-723-1032
www.colemanlawnyc.com

ATTORNEY

LEGAL SERVICES JAMAICA, WI

REAL ESTATE
ESTATE MATTERS
DIVORCES

Properties in Jamaica for sale online
www.osbournelaw.com

Antoinette Osbourne Attorney-at-Law
Call **718-502-9137**
162-02 Jamaica Avenue, 2nd Fl, Ste 5
Jamaica, NY 11432

ATTORNEY

Social Security/SSI Disability

Convenient to all Boroughs and Long Island

- NO FEE unless successful
- Over 40 years experience
- Personal and Friendly Service

Michael Schoffman
26 Court Street
718-852-0900

ATTORNEY

HAVE YOUR RIGHTS BEEN VIOLATED?

Call **718-243-0994**

CIVIL RIGHTS

- Police Brutality
- Excessive Force
- False Arrest
- False Imprisonment
- Malicious Prosecution

ATTORNEY

Antoinette Osbourne, ESQ.

By Appointment Only

IMMIGRATION- \$500 and up PLUS USCIS FILING FEES *
UNCONTESTED DIVORCE- \$400 and up + court fees (excludes svc costs)*
WILLS- \$300 and up* BANKRUPTCY
DIVORCE, CHILD SUPPORT, ADOPTION
REAL ESTATE, FORECLOSURE DEFENSE, LOAN MOD ESTATES
*conditions apply to quoted prices above.

QUEENS 162-02 Jamaica Avenue #5, Jamaica, NY 11432
(Entrance On Union Hall Street)
Rockland County 80 E. Rte 59 Suite A, Spring Valley NY 10977
Tel. **718-502-9137** Fax **718-301-1233**
osbourne@osbournelaw.com

ACCIDENTS	MEDICAL MALPRACTICE
Motor Vehicle Slip and Fall Trip and Fall Construction Accidents	Medical Misdiagnosis Surgical Errors Wrongful Death

WALE MOSAKU, P.C.
LAW OFFICES
25 Bond Street, Brooklyn, New York 11217

ATTORNEY

LOW FLAT FEE

BANKRUPTCY

FREE CONSULTATION

CONSUMER BANKRUPTCY

- CHAPTER 7 & 13
- ELIMINATE CREDIT CARD DEBT
- STOP CREDITORS HARASSMENT
- STOP FORECLOSURE
- STOP GARNISHMENT

DENRICK W. COOPER, ESQ

718-479-9500

CooperLegal@aol.com

207-23 Hillside Ave
Queens Village N.Y. 11427

WE ARE A DEBT RELIEF AGENCY

IMMIGRATION / CRIMINAL

FREE OFFICE CONSULTATION
212-571-9200



IMMIGRATION:
✓ Green Card
✓ Visa
✓ Deportation
✓ Immigration & Criminal Matters
✓ Green Card & Divorce
✓ Waivers

Feiner & Lavy, P.C., Attorneys at Law
www.FNLPC.com 325 Broadway Suite 401 • NY, NY 10007

العربية, Español, עברית, Русский Attorney Advertisement

ATTORNEY

FREE CONSULTATION



- Immigration
- Divorce
- Accidents
- Landlord/Tenant



Sunday and evening appt.
Call Attorney Abraham Chananashvili
Tel. **646-704-1062**
Conveniently located in Brooklyn, NY 11234

ATTORNEY

Oladeji O. Bolaji & Associates
Your One Stop Legal Center

- Real Estate
- Business Incorporation
- Immigration
- Change of Name
- Wills
- Landlord/Tenant
- Divorce

718-298-5251
www.oladejibolajilaw.com
91-16 Sutphin Blvd, Suite 202, Jamaica, Queens NY 11435

ATTORNEY

CARIBBEAN IMMIGRATION AND LEGAL DEFENSE CENTER
77 Water Street, NYC 10006
30 Years Attorney Experience In

FAMILY PETITIONS • MARRIAGE CASES
ADOPTIONS • NATURALIZATION
REMOVAL & DEPORTATION PROCEEDINGS
ADJUSTMENT OF STATUS • WORK PERMITS • MOTIONS TO REOPEN
FIANCE VISAS • STOKES INTERVIEWS • ADVANCE PAROLE

DIVORCE & ANNULMENT • FAMILY COURT • CRIMINAL COURT
SUPREME & CIVIL COURT LITIGATION • REAL ESTATE

Call: 212-349-4542

ATTORNEY - PERSONAL INJURY

CAR ACCIDENT? NEED A LAWYER?



212-571-9200

Car Accidents, Slip & Fall, Medical Malpractice, Dog Bites, Defective Products
FREE CONSULTATION • NO WIN, NO FEE
Over \$76 million in Claims • 98% WIN RATE!

Feiner & Lavy, P.C. Attorneys at Law
325 Broadway, New York, NY 10007

العربية, Español, עברית, Русский Attorney Advertisement

ATTORNEY

LAWRENCE O. OGBUTOR
Attorney and Counselor at Law
146-10 Hillside Avenue, 2nd Floor
Jamaica, New York 11435
718-206-0700 logbutor@verizon.net

REAL ESTATE • FORECLOSURES
LANDLORDS & TENANTS
DIVORCE AND FAMILY LAW • ADOPTION
ESTATE MATTERS • WILLS
COMMERCIAL LITIGATION • IMMIGRATION
AUTO ACCIDENTS AND
PERSONAL INJURY MATTERS

ATTORNEY

- FALSE ARRESTS
- ACCIDENTS
- CRIMINAL DEFENSE
- POLICE BRUTALITY
- PERSONAL INJURY
- TRAFFIC VIOLATIONS



LAW OFFICE OF MICHAEL J. LARSON, P.C.
401 Broadway, Suite 806, New York, NY 10013

Free Consultation • 212-528-0886
Email: Michael@mlarsonlaw.com • www.mlarsonlaw.com
No fee on false arrest or personal injury cases unless you recover
Former Prosecutor and United States Army Attorney

ATTORNEY

IMMIGRATION
All your immigration needs
Real Estate and Other Legal Matters
BROOKLYN LOCATION AVAILABLE
Call and inquire about immigration reform updates
516-374-5467 / 718-724-1000

Cedarhurst-575 Chestnut Street, NY 11516
1090 Coney Island Avenue 2nd Floor
Brooklyn NY 11230
CALL FOR APPOINTMENT
H. ZALCMAN-ATTORNEY AT LAW

ATTORNEY

Law Office of Lola Oni

\$80 Consultations

Let Us Be Your Strength!



- Immigration
- Landlord/Tenant
- Real Estate
- Family Law: custody, child support
- Criminal - And more

718-375-6800
1850 Flatbush Ave., 2nd Floor (between Ave. K & L)

DIVORCE/IMMIGRATION

UNITED BUSINESS SERVICE

***Divorce \$249** + court fee

no spouse signature required, no court appearance required
*Divorce usually finalizes within 60 days

Immigration \$80 up
Tax ID \$120

*the individual providing assistance to you is not an attorney licensed to practice law or accredited by the board of immigration appeals to provide representation to you before the bureau of citizenship and immigration authorities and may not give legal advice or accept fees for legal advice.

3618 Church Ave. Brooklyn NY 11203
718-941-5100

ATTORNEY



LEVINE AND WISS, PLLC
Attorneys at Law

ALL TYPES OF ACCIDENTS!

- AUTO ACCIDENTS
- MALPRACTICE
- SLIP/TRIP & FALL

&



INJURIES!

- CONSTRUCTION ACCIDENTS
- ALL OTHER TYPES OF INJURY CASES

Proud to announce the opening of our newest location in Brooklyn.
New York State's Sixth winningest Law firm for 2012. Source—Verdict Search
New York State's Seventh winningest Law firm for 2013.
Prior Results Do No Guarantee A Similar Outcome

Se Habla Español
1-888 GOT HURT (468-4878) • 718-575-2222
455 UTICA AVENUE BROOKLYN, NY 11203

LEGAL DIR. & HERE'S MY CARD

To Place Your Ad
Call 718-260-2555

DIVORCE

Absolute Divorce

Starting at **\$219** + court fees

Hablamos Español **RUSH SERVICE AVAILABLE**

80 Broad Street, 5th Floor,
New York, NY 10004

212-504-2985

www.absolutedivorceinc.com
all major credit cards accepted
"Must bring in this ad for \$219 Special"

COMPUTER REPAIR

- ✓ **COMPUTER REPAIR**
- ✓ **UPGRADE**
- ✓ **TROUBLESHOOTING**

Virus Removal • Data Recovery
Cracked Laptop Screen and
Broken Power Jack Replaced

Call James
646-281-4475
718-324-4332

CONSTRUCTION

(718) 941-3902

UNIVERSAL CONSTRUCTION & CARPENTRY CORP.

Lic. #HIC 1436395 & HIS 1074418

COMMERCIAL & RESIDENTIAL WATERPROOFING OUR SPECIALTY

- Steam Cleaning • Pointing
- Brick Work • Cement Work • Painting
- Brownstone • Roofing

Serving All Boros Fully Insured FREE Estimates

MACHINERY & EQUIPMENT

WATER PUMPS and GENERATORS
RENTALS • SALES • SERVICE

HONDA Power Equipment

"POWER WHEN YOU REALLY NEED IT"

LAPIETRA MACHINERY & EQUIPMENT INC.
1320 Third Ave., Brooklyn, NY 11230 (4th St.)
(800) 942-9950

Buy On-Line! www.LAPIETRA.com

Law Offices of Tracia Callender

One of the few Attorneys licensed in USA (New York and Washington, DC) AND sixteen Caribbean countries. Over seventeen years experience. An attorney who worked inside Judges' Chambers in New York (Federal and State) and in the Caribbean.

America	Belize	Grenada	St. Kitts-Nevis-Anguilla
Antigua	British Virgin Islands	Guyana	St. Lucia
Bahamas	Cayman Islands	Jamaica	St. Vincent
Barbados	Dominica	Montserrat	Trinidad and Tobago
			Turks and Caicos

IMMIGRATION - "call TC"
FORECLOSURE - "call TC"
WILLS & TRUST - "call TC"
PROPERTY (Buy, Sell or Rent Residential & Commercial) - "call TC"
PERSONAL INJURY - "call TC"

DIVORCE - "call TC"
CRIMINAL - "call TC"
BUSINESS - "call TC"
CONTRACTS - "call TC"
EMPLOYMENT - "call TC"
CHILD SUPPORT - "call TC"

(646) 369-9732
tccesqq@gmail.com
www.lawofficesoftraciacallender.com
Use code "Call TC" and receive discounts and special offers.

ONE HOUR PEST CONTROL

STOP LIVING WITH ROACHES & MICE

Monthly Roach Service\$29.99
Monthly Mice Service.....\$29.99
Monthly Mice & Roach Service\$39.99

STUDIOS, 1,2,3 BEDROOM APARTMENTS **CALL 212.289.0400**

MOVING

SP MOVING

All Types of Moving
Reliable Dependable Reasonable Rates

Free Estimates
We Do Rubbish Removal

718-339-8888

EXTERMINATOR

BED BUGS

ACTION EXTERMINATOR
212-465-7524

10% Discount if you ask for Charles

Broken laptop

or any type of electronics?

Find a Service Technician in our SERVICE DIRECTORY

CARPET & UPHOLSTERY

TRUE CLEAN CARPET & UPHOLSTERY

CLEANING SPECIALIST
RESIDENTIAL & *COMMERCIAL

CARPET	UPHOLSTERY
\$50 per room	\$90 Sofa
\$25 per hall	\$75 Luv Seat
\$5 per step	\$60 Chair

Call **718-287-0579**
*Call for Commercial Carpet & Upholstery Cleaning prices

CONSTRUCTION

KW Construction & Renovation Inc
General Contractor
Yonkers Lic. #5056
Westchester Lic # :NYC-22361-1109
Lic# 1395520

WATERPROOFING & ROOFING

ALL KINDS OF ROOFS

- Steam Cleaning • Brick Pointing • Masonry Work
- Scaffold Work • Bathroom/Kitchen/Tile • Sidewalks
- Stucco • Painting • Sheetrock Work • Siding/Gutter

NOBODY CAN BEAT OUR PRICE!!!

30 Years Experience
We can help you remove all kinds of violations

EMERGENCY SERVICE FREE ESTIMATES FULLY INSURED LICENSED BONDED

1284 Mace Ave, Bronx, NY 10469
AHMED: 718-652-6444/Cell: 917-567-2143

FURNITURE REUPHOLSTERY

Perfect Touch Decorators

Expert Reupholstery All Furniture

AMAZING SPECIAL!

Kitchen Seats \$55
Including Vinyl (pullover)

Verticals/Mini Blinds • Cushions Refilled
Recaning • Slipcovers - Plastic & Fabric
FREE Shop-at-Home Estimates
Quality Service Over 30 Years Experience
718-263-8383

CHIMNEY & FIREPLACE

CHIMNEY & FIREPLACE

Cleaning & Inspection

- Clean • Repair • Re-Line
- Rebuild All Masonry Work
- Roofing & Siding • Blockages Removed
- Gas Company Shut-offs
- Oil Burner Chimneys
- Violations Corrected
- Carbon Monoxide Spillage Resolved
- Gas Furnace Chimneys

\$59⁰⁰

FREE ESTIMATES SENIOR DISCOUNTS

ALL BOROUGH CHIMNEY & FIREPLACE, Inc.
718-755-3046

LIC. & INSURED DCA #1280321 24/7 Emergency Service

CONSTRUCTION

NEW HEIGHTS CONSTRUCTION LLC

Siding • Windows • Roofing
Fences • Kitchens • Painting • Baths
Basements • Decks • Doors
Awnings • Patio Enclosures
Brick Pointing • Concrete Stucco

FALL SPECIALS ON WINDOWS

VISIT OUR ONLINE SHOWROOM

NYC License #1191201
www.newheightsconstructionllc.com
800-525-5102
718-767-0044

FREE ESTIMATES

HOME IMPROVEMENT

HERON CONSTRUCTION

Specializing in:

- Kitchens & Bathrooms • Finished Basements
- Painting & Plastering
- All Kinds of Carpentry & More

Lic. #1252474 • Fully Insured

Professional Work You Can Trust

718-450-1851
520-718-277-1963
www.HeronConstruction.net
email: heron80@aol.com

Call Today for a FREE ESTIMATE

DIGITAL RECRUITMENT ADVERTISING SALES ACCOUNT EXECUTIVE

CNG (Community News Group) is currently seeking a Digital Recruitment Advertising Sales Account Executive.

In this role, you will sell digital and print recruitment advertising campaigns with an emphasis on digital recruitment advertising.

You will custom craft advertising campaigns that contain successful components of digital online verticals, such as custom search, resume-matching.

You will also have the ability to work with additional sectors for both digital and print marketing opportunities such as real estate and other service sectors.

RESPONSIBILITIES

- Identify client needs, communicate the benefits of our audience-based marketing solutions as they relate to each need and then sell the appropriate campaign.
- Negotiate contracts.
- Manage day-to-day activities using a CRM system.
- Meet or exceed revenue expectations.

QUALIFICATIONS

- Sales experience.
- Understanding of digital media platforms and be digitally savvy.
- Proficient in sales calling including up-selling, appointment setting and cold calling.
- Ability to work through objections/concerns regarding costs, budgets and selling strategies.

POSITION OFFERS

Base salary plus commission, 401 K, Paid Vacation and medical

Please send your resume and cover letter to: epechenaya@cnglocal.com



Dr. Alan P. Goldman: Treating And Relieving Arthritis Pain

There are a lot of people suffering with joint pain and arthritis, says **Dr. Alan P. Goldman**, a specialist in rheumatology (130 Brighton Beach Avenue, 718-946-7557), and they often believe that there is little that can be done to alleviate their pain.

They are wrong. There are many options available, Dr. Goldman says; the key is finding a physician who is knowledgeable in those treatment modalities.

As a rheumatologist, Dr. Goldman specializes in the treatment of arthritis; one of only a handful practicing in Brooklyn.

Rheumatoid arthritis is an inflammatory illness that causes joints to swell. Symptoms include morning stiffness and swelling, often in the hands, elbows, or wrists, he says. Perhaps because there are so few rheumatologists in the borough, when people experience these symptoms, they often "see a surgeon first," says Dr. Goldman. But this often doesn't make much sense, he explains.

"When you have stomach pains, you don't go to a surgeon before seeing a gastroenterologist," he explains. "When you have chest pains, you don't see a surgeon before seeing a cardiologist."

A surgeon is the expert to see when surgery is needed, he notes, and of course Dr. Goldman refers patients to surgeons when necessary. Still, Dr. Goldman believes that the majority of people who suffer with arthritis can be

treated without surgery. Even those who suffer enormously may find relief with Remicade IV infusion treatments, he says. "It has worked wonders."

Patients receive these treatments once every few months, and people who previously couldn't move well find that the "benefits are tremendous," he says. Those whose symptoms are less severe may find relief with pills or injections. This method has been used successfully for many years, says Dr. Goldman. And, "It still works."

When patients see Dr. Goldman they are assured of receiving expert evaluations. Dr. Goldman's office offers x-rays, and a number of in-office treatment procedures. Should patients need physical therapy, arrangements can be made for this, as well.

Dr. Goldman also recommends that people age 60 or older come in to be checked for osteoporosis. People who are thin or who smoke are especially at risk, he notes.

Dr. Goldman is a Harvard graduate who has studied at Bellevue Hospital-New York University Medical Center and Gouverneur Hospital in Manhattan. He is on staff at the New York Methodist Hospital, and he is a Fellow of the American College of Rheumatology, as well as a member of the American College of Physicians, Nassau County Medical Society, the New York State Medical Society, American Medical Association, and the New York Academy of Sciences.

**Exclusive
New Diagnostic Method:
Musculoskeletal Ultrasound.
Positive diagnosis of bursitis, tendinitis,
rotator cuff and meniscal tears
without MRI!**

ARTHRITIS

**You Just
Learn To Live
With It, Right?**

WRONG!

Dr. Alan P. Goldman

**Board-Certified Arthritis Specialist
Has The Latest**

NON-SURGICAL Treatments:

Treatments May Include Medicines, Injections & Other Therapies.

"Caring, Not Just Curing"

- Rheumatoid Arthritis
- Osteoarthritis
- Bursitis
- Carpal Tunnel Syndrome
- Tendonitis
- Lyme Disease
- Gout
- Low Back Pain
- Neck Pain
- Shoulder Pain
- Lupus
- Psoriasis Arthritis

New portable ultrasound technique from Israel!

Excellent for intractable tennis elbow and achilles tendinitis!

DR. ALAN P. GOLDMAN

718-946-7557

By Appointment Only

130 Brighton Beach Ave.

(Cor. Of Ocean Pkwy. & Brighton Beach Ave.)

Brooklyn, NY 11235

**FREE
Transportation
Available**

**Medicare
And Most Other
Insurance
Assignments
Accepted**

**Alan P. Goldman, A.B. Cum Laude Harvard University; A.M., Harvard University; M.D.,
Albert Einstein College Of Medicine; Internal Medicine Training, N.Y.U. Bellevue; Rheumatology Fellowship - N.Y.U.;
Member, American College Of Physicians; Fellow, American College Of Rheumatology**