

# Caribbean Life

www.caribbeanlifeneews.com

BROOKLYN/STATEN ISLAND EDITION

June 13-19, 2014 CNG

FREE



**INSIDE: LEARN TO EARN  
CAREER TRAINING**

**SPECIAL READER BONUS  
FREE coupons to save you CASH**

**NEW HOROSCOPE  
SECTION INSIDE**



## New Zealand takes the advantage

New Zealand batsman Kane Williamson, left, plays a shot as West Indies wicket-keeper De-nesh Ramdin (center), and Chris Gayle, (right back), look on during the opening day of their first cricket test match in Kingston, Jamaica, Sunday, June 8, 2014. See page 46.

AP Photo/Arnulfo Franco

## Heimlich maneuver a Senate life saver

By Chudi Chukwudi

A frightening moment in the New York State Senate that could have taken the life of a Brooklyn representative was averted by the heroic actions of a State Assemblyman and a Senate staffer.

Assembly Speaker Sheldon Silver explained the incident and the consequences in a news release Wednesday after the incident and acknowledged the heroic actions of Assemblyman Sean Ryan and Assembly Staff Member Bakary

Janneh, as follows:

"As many of you know, an emergency transpired on the floor of this House last week," he said, adding: "One of our colleagues, Assembly Member

Continued on Page 4

# DIRTY GUYANA POLICE

## Police Association rankled by rogue members of the ranks

By Bert Wilkinson

In recent years, opposition groups, active media, rights organizations and ordinary Guyanese have watched in awe as the police administration grapples with a growing brigade of rogue cops engaged in open torture of criminal suspects, widespread

demand for bribes and a string of other atrocities that have reached to such an alarming stage that the umbrella police association says it now feels compelled to act.

In recent days, the association that represents about 2,500 junior officers and ordinary ranks, says it

Continued on Page 4



## WANT TO LOSE 25 TO 50 POUNDS IN 60 DAYS... GUARANTEED

SEE OUR AD ON PAGE 19

# CARIBBEAN ROUNDUP

Updated daily at [www.caribbeanlifeneews.com](http://www.caribbeanlifeneews.com)

THE NEWS FROM BACK HOME

## Antigua

The ruling Antigua United Progressive Party (UPP) has promised that no new taxes will be introduced if it is re-elected government on June 12.

It has also pledged in its just released election manifesto that none of the existing taxes will be increased.

The manifesto dubbed, "The People's Charter", was unveiled recently before an audience of about 300 supporters at the Sandal Grande Antigua Resort.



The document promised further income tax relief of up to 20 percent, for thousands of low to middle income earners.

Among the promises is a regeneration of the Free Trade Zone to promote exports, the creation of jobs and attracting foreign direct investment.

The UPP said it would provide generous incentives to companies that import raw materials and manufacture finished products for export.

The UPP is relying on its agenda for the next years, which include economic stability to economic resilience, from social transformation to social cohesion, human development and promoting vibrant communities.

## Cuba

Cuba welcomed 1.28 million tourists between January and April this year - a five percent rise compared to the same period in 2013.

According to the National Statistics and Information Office (ONEI), the Spanish-speaking island, welcomed in April alone 287,103 foreign visitors, up four percent year-on-year.

Canadians continue to outnumber all other visitors to the island with 623,337 arrivals, followed by Germans with 55,238, according to PNEI, which noted that British, French and Italians tourists were also at the forefront of visitor numbers.



In 2013, Cuba attracted 2,852,572 tourists to its shores, more than a million of them from Canada. That number was just 150,000 short of the three million goal and



## Transition gaps for immigrant children

Most immigrant parents of children like this star soccer player want to be engaged in the lives of their sons and daughters but face obstacles in doing so. See story on page 8.

IPS/Marcelo Brociner

tourism authorities are aiming for this year.

Tourism is Cuba's second leading source of foreign revenue, with income of some \$1.8 billion in 2013, most of it for accommodation and food, according to official figures.

## Guyana

The United States has reaffirmed its commitment to work closely with the government of Guyana to combat the illicit trafficking of narcotics and illegal weapons.

At the signing of an agreement recently for the provision of additional funds in the amount of US\$850,000, US Ambassador, Brent Hardt said the citizens of Guyana should experience the benefits of improved security.



The agreement signed by Foreign Affairs Minister Carolyn Rodrigues-Birkett and the ambassador, is the third amendment to the Narcotics Control and Law Enforcement agreement to support several on-going and new programmatic activities.

It also includes enhanced training in police functions such as evidence gathering, interrogation methods, and case development, Hardt said.

It will also focus on specialized investigation in the areas of human trafficking, gender-based violence, corruption and money laundering.

The funds will also go towards strengthening Guyana's correction service, with particular focus on the management and rehabilitation of juvenile detainees.

Since 2011, both governments, under the Caribbean Basin Initiative partnership have been working towards a common goal of building safer and more secure communities, the minister said.

## Jamaica

Jamaica's government says it is launching a US\$5 million welfare-to-work program that is expected to benefit some 2,000 people.

This was disclosed by National Security Minister Derrick Kellier who said the program will be implemented in the next two years.



He said the program aims to reduce the number of people who receive financial support and prepare them to enter the workforce.

The island's 2.9 million people has a 16 percent unemployment rate and nearly 17 percent of the population lives below the poverty line.

## St. Lucia

St. Lucia Prime Minister Dr. Kenny Anthony has assured Caribbean rum producers that marketing campaign to position Authentic Caribbean Rums in Europe and internationally has the backing of Caribbean governments.

Dr. Anthony was at the time speaking at a regional rum exposition in St. Lucia recently, which hosted 16 Caribbean rum producers and journalists from six European countries.

The prime minister acknowledged that despite victories at rum festivals worldwide, the Caribbean had a lot to do to maintain its foothold in traditional markets in Europe and to establish new markets.



He said although the region was known for the "absolute quality and excellence" in the rums produced, it still had to deal with competition in the international market.

The exposition was organized by the West Indies Rum and Spirits Producers Association to introduce to the visiting European journalists the Authentic Caribbean Rum marketing campaign and the mark associated with it.

## St. Vincent

A magistrate in St. Vincent and the Grenadines has jailed a mother of four for one year for burning her six-year-old son three times with an iron.

Tashika Da Souza, 23, pleaded guilty to a charge of grievous bodily harm before Magistrate Rechanne Browne-Matthias in the Kingstown Court last week.



Da Souza told the magistrate that she did not know the iron was hot when she pressed it against her son's left hand and abdomen.

Chief Prosecutor Adolphus Delphelec described the act as "wicked, backward and barbaric."

The court heard that Da Souza's son defecated on himself after she prepared him for school. She then burnt him with the iron.

## Trinidad

A Surinamese-born Dutch national was extradited to Singapore to face trial for fraud.

A r m a n a t h Jagmohan, who was detained in Trinidad since he was arrested on a provisional warrant in January last year, has lost his battle in the Trinidad High Court and Court of Appeal to avoid extradition.



It is alleged that sometime in May 2003, Jagmohan visited several money lenders in Singapore and attempted to change counterfeit euros. He was charged in Singapore but fled the country before his trial while on bail. He was held in Trinidad and Tobago on Jan. 29, 2013.

## Guyana

Guyana police are searching for two men in connection with the discovery of 10 pounds of cocaine worth millions of dollars hidden

Continued on Page 18



Left: CCH Pounder. Right: Machel Montano

Photo credit: Tangerine Clarke

# Messages of hope for a brighter future

## At UN, Carib artists address world issues

**By Tangerine Clarke**

Trinidad and Tobago superstars David Rudder and Machel Montano on June 6 joined artists at the UN in a global message of hope for a better future in the year 2015 and beyond.

Wearing a white ensemble, Montano's energetic performance got the audience to their feet and to the front of stage where he wowed guests with his chart-topping hits, calling on leaders to end hunger in the world.

"Haiti, I am sorry," said Rudder "One day we will lift our heads and see the glory to end poverty."

It was indeed an historic moment at UN headquarters as he joined a throng of fans to implore world lead-

ers to end poverty. The flag of Antigua&Barbuda was waved with excitement as Soca artist Tizzy revved up the audience as he called on the world to end abuse and trafficking of women and children.

The electrifying evening of music was inspired by the Antigua-born president of the General Assembly John Ashe, who said everyone has a role in making the world a better place.

"The lives of generations to come, the planet we call home and the future of all that encompasses our world depend on the actions we take today," he said.

Secretary General Ban Ki-Moon, who joined Ashe on stage for a traditional African dance with Jai, reit-

erated that the year 2015 is a once-in-a-generation opportunity, adding that "our duty is to end poverty, leave no one behind and build lives of dignity for all," as he set the stage for the 2015 UN initiative to address critical issues affecting the world today, that will be addressed by world leaders next year.

The evening was punctuated by the pulsating rhythms of the islands, but it was former child-soldier Emmanuel Jai whose spoken-word poetry and rap music prayed for hope for the billions of people around the world, where every child can go to school and where all women and girls would not fear violence.

"Our weapon is music,"

said Jocelyne Bernard, as she called on people around the world to come together as one for a better understanding of each other.

The 60 million people still living in poverty in Bangladesh was brought into focus by artist Sumi, who said that despite recent process women make up the largest number of citizens who are hungry.

The evening of poignant tributes from all of the artists whose passions were heard in their lyrics ended with the words of Bob Marley: "One Love: Let's Get Together and Feel All Right."

The concert was co-hosted by veteran actress CCH Pounder and MSNBC Anchor T.J. Holmes.

## The measure of a man

**By Kenton K. Kirby**

The community Basil Paterson loved and served -- and who loved him in return, came together recently at a memorial service at the Cathedral of St. John the Divine in Upper Manhattan and literally raised the roof of the famous church, during a poignant celebration of a life well lived.

Set in motion with the well-known hymn, "Blessed Assurance" led by the magnificent church choir; with the pipes of the great organ at full blast, yet almost stifled by the voices of mass congregation; the stability of the roof of the great church's literally seemingly under threat.

Goose bumps were in high order during the magnificent musical rendition, and remained at large throughout the ceremony, as speaker after speaker who knew Basil Patterson -- some with tears slipping down their cheeks, spoke of this giant-of-a-man, yet humble, who touched the lives of many.

From the get-go, an evening of tributes poured from the lips of all who knew Mr. Paterson; some very well, others not so well, as they heaped mountains of praise on the former lieutenant governor.

The Venerable Dr. James Forbes officiated at the service.

**Read some of the tributes.**

**The One Hundred Black Men fraternity:**  
"Basil Patterson's was a life well lived."

**Governor Andrew Cuomo:**

"A lawyer's lawyer."  
"A mediator's mediator."  
"Basil Paterson was marching in Memphis because he believed that was what Dr. King would have wanted." "We're all the better for it."

**Mayor Bill DeBlasio:**

"Praised the relationship with David Dinkins, for 1199 and the Labor Movement. His "signature calm amidst the stormi  
"He (taught us all) how to be leaders."  
"Like a leader, he went after the flock and led from behind."

**Former Mayor David Dinkins:**

Spoke of Basil Batterson's signature "calm  
Continued on Page 28



Family members and friends at the Basil Patterson memorial service.

Photo by Leonard McKenzie

# Dirty Guyana cops up to no good

Continued from cover

has become so ashamed of the actions of dirty officers in the force that it has sent representatives on missions to visit police stations to remind active officers and supervising ranks that the situation is getting out of hand and is bringing the entire system into disrepute.

Quiet and if not dormant for years, the association surfaced with a highly unusual statement this week just days after two officers were criminally charged with grievously harming a 15-year-old high school student by shooting him in the mouth because they believed he was withholding vital information about an armed robbery involving the relative of one of the policemen. One of the policemen was a cadet officer on probation.

Both have been remanded to prison and could face

up to 15 years in jail if convicted. The victim is being treated in hospital. He has told reporters that the officer played a game of Russian Roulette with him and appeared surprised when the revolver's spinning chamber lined up and ejected a bullet that nearly killed him. The magistrate remanded him to jail because of a previous attempt to bribe the victim, expressing fears that the same will occur if out on bail.

The statement was also issued by the body about two weeks after a policeman at a coastal station was crazy enough to pour a flammable liquid onto the hands of suspect in station detention and set them alight and about six months after another allegedly sodomized another suspect with a condom-covered baton at a station near the main airport. The

officer involved in this case has also been charged but is out on bail. The 19-year-old remains hospitalized while police complete their investigations into the matter.

The latest case of a suspect being set alight has come about five years after a group of policemen on the west coast poured a similar liquid on the genitals of a 15-year old and set them alight, scarring him for life. The state paid him a mere \$30,000 in compensation.

Apart from the association, opposition legislators and the Guyana Human Rights Association and Justice Cecil Kennard who heads the police complaints have all spoken out against the growing number of police torture and brutality cases urging immediate action by the top brass.

The body said that rogue

cops engaged in "venalities, inappropriate conduct and other transgressions, which tend to stigmatize the organization and bring into disrepute the credibility of the many hard working policemen and women. Supervisors must take swift, decisive and appropriate action against defaulting ranks," the association said.

Similar acts of brutality that prisoners and criminal suspects say they felt were ignored by the state led to the shooting deaths of 27 law enforcement officers between 2002-04. Most were killed by inmates on inordinately long periods of remand without trial who broke out and formed a murderous gang that killed a prison guard, a narco police officer, a soldier and 24 policemen. Critics fear a repeat of this if the police administration does not act quickly.

# Annette Robinson

Continued from cover

Annette Robinson, was choking and unable to breathe. A number of you immediately came to her aid, most notably Assembly Member Sean Ryan, who made several valiant attempts to dislodge the obstruction.

"Sean, we thank you for your heroic efforts.

"Recognizing that Mrs. Robinson's situation was worsening, a young man who was sitting in this Chamber at the time, Bakary Janneh, who is both a member of our Program and Counsel staff as well as a volunteer EMT with the local Mohawk Ambulance Corps came to the rescue, lifted Ms. Robinson from the floor, performed the Heimlich Maneuver with precise, technical perfection and saved her."

"Assembly Member Robinson, on behalf of the House, let me say how wonderful it is to know that you are well and back in action. As you know better than

anyone, it was a frightening moment and we are greatly relieved to see that you are okay."

The speaker asked Mr. Janneh, if he would stand and be recognized by the House, and continued:

"Bakary, first and foremost, let me say 'thank you.' Your calm, swift action prevented an accident from becoming a tragedy. We are fortunate indeed to have someone with your life saving training serving in the Assembly.

"In considering your actions last week and in reviewing your resume, you are clearly demonstrating both exceptional leadership qualities and a strong, selfless commitment to serving the greater good.

"Bakary, we salute your heroic actions and we are proud that you are a member of our Program and Counsel staff.

"My colleagues, let us join in giving Bakary Janneh a much deserved round of applause."

Go to [www.Caribbeanlifeneews.com](http://www.Caribbeanlifeneews.com) for the latest in Caribbean news and more.

## PERSONAL LOANS AVAILABLE

**BAY RIDGE FEDERAL CREDIT UNION**

DATE: \_\_\_\_\_

PAY TO THE ORDER OF: Your Name Here \$10,000.

**Ten Thousand** DOLLARS

**Borrow \$10,000 for as low as \$300**

**BAY RIDGE FEDERAL CREDIT UNION**  
1750 86th Street • Brooklyn, NY 11214  
Phone: 718-680-2121 • www.brfcu.org

MEMO: \_\_\_\_\_

Payment	Amount Financed	No. of Payments
\$300*	\$10,000	41*
\$150*	\$5,000	41*
\$100*	\$2,500	29*
\$50*	\$1,000	23*
Higher Loan Amounts Available		
\$400*	\$15,000	48*

- Loan rates lower than credit card rates
- Installment loans raise your credit score
- Apply online, by phone, or stop in

**BAY RIDGE FEDERAL CREDIT UNION**

MAIN OFFICE:  
1750 86th Street • Brooklyn, NY 11214  
Phone: 718-680-2121 • www.brfcu.org

BRANCH:  
1609 Avenue Z • Brooklyn, NY 11235  
Phone: 718-934-6809

Apply Online at [www.brfcu.org](http://www.brfcu.org)

\*Payments based on 8.95% annual percentage rate with automatic loan payments. Rates are based on credit worthiness. Other rates and terms available. Higher loan amounts available. Credit Union membership eligibility is required.

## Clear Healthy Skin isn't it time you call?

**Medical Services** we accept:

GHI, HIP, 1199, AETNA, CIGNA, UNITED, OXFORD, HORIZON, HEALTHNET, MEDICARE, BLUE CROSS, MAGNACARE, AMERICHOICE, ELDERPLAN

**Cosmetic Services** Botox, Restylane, Juvederm, Radiesse, Sculptra, Laser Hair Removal, Laser Tattoo Removal, Laser Vein Removal, Torn Earlobe Repair, Keloid Surgery...

**Coolsculpting** Trim Fat, No Needles, No Downtime

**254 Prospect Park West Park Slope**

**136 West 17th Street NYC**

Javier Zelaya, MD  
Verna Broughton, PA

**718.832.3313**

After creating a budget and setting goals, Jared and Kristina are paying down credit card debt.

Read Jared's and Kristina's story on NYCDCA:

nyc.gov YouTube Twitter Facebook Instagram

# YOU CAN IMPROVE YOUR CREDIT.

Financial Empowerment Center

We've helped New Yorkers ...

Improve credit Save for the future

Tackle debt Open a bank account

We can help you, too.

Call 311 to schedule an appointment for FREE one-on-one financial counseling at an NYC Financial Empowerment Center near you or visit [nyc.gov](http://nyc.gov) for information.



Department of Consumer Affairs  
Office of Financial Empowerment

Bill de Blasio  
Mayor

Julie Menin  
Commissioner

NYC Financial Empowerment Centers are in all five boroughs. To find the Center in your neighborhood, call 311 or visit [nyc.gov](http://nyc.gov).

**The Bronx**  
Concourse Village  
Melrose  
Unionport  
West Farms

**Brooklyn**  
Bedford-Stuyvesant  
Brownsville  
Bushwick  
East Flatbush  
Flatbush  
Prospect Heights

**Queens**  
Far Rockaway  
Jackson Heights  
Jamaica  
Long Island City  
Woodside

**Manhattan**  
Garment District  
Hell's Kitchen  
Lower East Side  
Manhattanville  
Washington Heights

**Staten Island**  
Port Richmond  
Randall Manor

# ARTHRITIS? LUPUS? OR JOINT PAIN?

Individual treatment options are designed by **Dr. Victoria Katz** and her associates to ensure positive outcomes.

*Your good health is the key to our success.*

**Specializing in Treatment of Joint & Rheumatic Diseases & Painful conditions of the joints.**

- Latest Joint Diagnostics
- Physical Therapy & Rehabilitation
- On Premises Lab & Diagnostic Services
- Ultrasound Guided Injections
- Nutrition Counselling
- IV Chelation Therapy

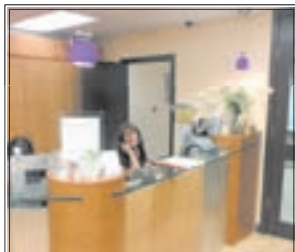

## NY ARTHRITIS CLINIC 718-375-2300

1664 East 14<sup>th</sup> St., Suite 401  
Brooklyn, NY 11229

71-36 110<sup>th</sup> St., Suite IJ  
Forest Hills, NY 11375

51 East 42<sup>nd</sup> St., Suite 1808  
New York, NY 10017

# Stay comfy all year round

Keep your home cozy with **FREE** energy upgrades



Everyone should be comfortable at home. That's why the EmPower New York program provides income-eligible residents\* with free energy upgrades—all at no cost to you. To learn more and see if you're eligible, visit [nyserdera.ny.gov/comfort](http://nyserdera.ny.gov/comfort).

**>> EmPower New York. A better life begins at home.**

\* You may be eligible for EmPower New York if you are eligible for HEAP benefits, participate in a utility payment assistance program or have a household income below 60 percent of the state median (around \$50,000 for a family of four).



**nyserdera**  
Energy. Innovation. Solutions.

# eyeglass direct

**NOW CARRYING  
Ernest Hemingway  
Vintage Inspired  
Eyewear**



**Polycarbonate  
Lenses with Frame  
\$45 Complete**

**Now Available  
High Definition  
Digital Progressives**  
*Call For Pricing & Info*

Flat Top  
**Bifocal**  
Frame & Lenses  
**\$69**  
Complete

Any Standard Metal or Plastic  
Frame with CR39 Lens

**Progressive**  
Frame & Lenses  
**\$75**  
Complete

Any Standard Metal or Plastic  
Frame with CR39 Lens

**Progressive  
Transition**  
Frame & Lenses  
**\$149**  
Complete

Any Standard Metal or Plastic  
Frame with CR39 Lens

Rimless  
Titanium Frame  
& Polycarbonate  
Lenses  
**\$99**  
Complete

Single Vision Only

**With every pair of eyeglasses,  
you will receive:**

- High Quality Prescription Lenses
- Anti-Scratch Protection
- Ultraviolet Filter
- High Polished Lens Edges
- High Quality Eyeglass Case
- Micro Fiber Cleaning Cloth



**NOW AVAILABLE**  
**State of the Art Eyeglass Frame  
Repair and Lens Replacement.**



**Factory Direct Prices**  
Available Products



**4909 Avenue N**

(Between Utica Avenue & E. 49th Street)



**FREE  
PARKING**

**718-444-1092**  
**866-LENS-790**  
www.eyeglassdirect.com

**Monday-Friday 9am-6pm; Saturday 10am-5pm; Closed Sunday**



Boro President, Eric Adams (center) with members of the APC, Inc. Community Group.

## Towards a healthier B'klyn

**By Nelson A. King**

Brooklyn Borough President Eric Adams says he's committed to building a healthier Brooklyn.

"My goal is how to build a healthy Brooklynite," Adams told the Fifth Annual Caribbean Health Summit on Jun. 5, organized by the Brooklyn-based community group, APC (Action, Performance, Commitment) Community Services, Inc., in conjunction with Kings County Hospital Center (KCHC), Kingsbrook Jewish Medical Center (KJMC) and the American Heart Association.

"Part of this healthcare must move away from the current healthcare system," added Adams at the day-long event at KCHC's auditorium. "Here, we must go to another level in America.

"How do we become more spiritually-grounded?" he asked rhetorically. "I don't want to build another building; I want to build people."

Adams said his office was expected to commence mediation workshops this week, stating that he is fully committed to making Brooklyn residents more healthy.

According to summit participants, health care statistics show that Caribbean populations living in Brooklyn suffer disproportionately from a variety of health care concerns,

**"Part of this  
healthcare must  
move away  
from the current  
healthcare system.  
Here, we must go  
to another level in  
America.**

including diabetes and cardiovascular diseases.

Stating that health care literature indicates that medical providers need to be trained to provide comprehensive, culturally-competent care to Caribbean and other minority patients in reducing health disparities, organizers said that the summit addressed practice gaps for medical practitioners who provide care to Caribbean and other populations.

The conference focused particularly on diabetes, heart disease and stroke, with presentations from, among others, Drs. Michelle Johnson, assistant chief of cardiology, Memorial Sloan Kettering Cancer Center; Nao-Solo Tetty, cardiovascular health education and community outreach coordinator, New York Presbyterian Hospital; Ronald Pedalino, director of cardiology at KCHC; Kurt Kodroff, chair, Department of Medicine, KJMC; Saka Kazeem, chief of endocrinology, KJMC; and Janice Emanuel-Bunn,

APC Community Services, Inc. president.

Suzette Williams, Family Nurse Practitioner at KCHC, Dr. Mauvareen Beverly, deputy executive director, case management, KCHC, and Dr. Michael Biglow, of KJMC, also presented on diabetes, cardiovascular programs and healthcare in general. KCH executive director, Ernest Baptiste, welcomed participants.

Experts urged attendees to practice health living by eating healthy and exercising regularly.

"Follow a meal plan, self-monitor and exercise," Williams urged diabetic patients. "Self-monitoring glucose is very important."

The experts said diabetes is a condition in which sugar levels are high, adding that, when one has diabetes, one's pancreas makes little or no insulin; and that the body prevents the insulin that one makes from working right.

As a result, sugar can't get into one's cells; so it stays in the blood, causing the blood sugar to get too high. This condition is called hyperglycemia.

Kelvin Smith, 51, author of "The Unlikely Candidate" and heart transplant patient, testified about complications from heart disease.

"I was blessed by an angel," he said. "Heart failure did not choose me. I was chosen by heart failure."

# LOWEST PRICES & OUR BIGGEST ONE DAY SALE

OF THE SEASON

LOOK FOR OUR LOWEST PRICES ON SELECTED ITEMS STOREWIDE!

**SATURDAY, JUNE 14 SHOP 8AM-11PM**

(IT'S A SALE TOO BIG TO FIT IN A DAY!)

**ALSO SHOP TODAY, JUNE 13 FROM 8AM-10PM**

HOURS MAY VARY BY STORE. VISIT [MACYS.COM](http://MACYS.COM) AND CLICK STORES FOR LOCAL INFORMATION.

## ONE DAY SALE DEALS OF THE DAY

SPECIALY SELECTED ITEMS PRICED SO LOW YOU DON'T NEED A SAVINGS PASS!  
AVAILABLE ALL DAY, BOTH DAYS

## DOORBUSTERS

5 HOURS ONLY! 8AM-1PM FRI & SAT-GET HERE EARLY, WHILE THEY LAST!

OR, EXTRA SAVINGS FRIDAY AND SATURDAY 8AM-1PM

SAVINGS PASS DISCOUNT DOESN'T APPLY TO DOORBUSTERS OR DEALS OF THE DAY

★macy's **WOW!** \$10 OFF  
ALL SALE & CLEARANCE APPAREL & SELECT HOME ITEMS (EXCEPT DOORBUSTERS & DEALS OF THE DAY)

**\$10 OFF**

**YOUR PURCHASE OF \$25 OR MORE.**

VALID 6/13 'TIL 1PM OR 6/14/14 'TIL 1PM. LIMIT ONE PER CUSTOMER.

ALSO EXCLUDES: Everyday Values (EDV), specials, super buys, furniture, mattresses, floor coverings, rugs, electrics/electronics, cosmetics/fragrances, athletic shoes for him, her & kids, Dallas Cowboys merchandise, gift cards, jewelry trunk shows, New Era, Nike on Field, previous purchases, special orders, selected licensed depts., special purchases, services, macys.com. Cannot be combined with any savings pass/coupon, extra discount or credit offer, except opening a new Macy's account. Dollar savings are allocated as discounts off each eligible item, as shown on receipt. When you return an item, you forfeit the savings allocated to that item. This coupon has no cash value & may not be redeemed for cash, used to purchase gift cards or applied as payment or credit to your account. Purchase must be \$25 or more, exclusive of tax and delivery fees.



★macy's **WOW!** \$20 OFF  
ALL SALE & CLEARANCE APPAREL & SELECT HOME ITEMS (EXCEPT DOORBUSTERS & DEALS OF THE DAY)

**\$20 OFF**

**YOUR PURCHASE OF \$50 OR MORE.**

VALID 6/13 'TIL 1PM OR 6/14/14 'TIL 1PM. LIMIT ONE PER CUSTOMER.

ALSO EXCLUDES: Everyday Values (EDV), specials, super buys, furniture, mattresses, floor coverings, rugs, electrics/electronics, cosmetics/fragrances, athletic shoes for him, her & kids, Dallas Cowboys merchandise, gift cards, jewelry trunk shows, New Era, Nike on Field, previous purchases, special orders, selected licensed depts., special purchases, services, macys.com. Cannot be combined with any savings pass/coupon, extra discount or credit offer, except opening a new Macy's account. Dollar savings are allocated as discounts off each eligible item, as shown on receipt. When you return an item, you forfeit the savings allocated to that item. This coupon has no cash value & may not be redeemed for cash, used to purchase gift cards or applied as payment or credit to your account. Purchase must be \$50 or more, exclusive of tax and delivery fees.



**FREE SHIPPING & NEW! FREE RETURNS AT MACYS.COM**

Free Shipping with \$99 purchase. Free returns by mail or in-store. U.S. only. Exclusions apply; details at [macys.com/free-returns](http://macys.com/free-returns)



ONE DAY SALE PRICES IN EFFECT 6/13 & 6/14/2014. "Season's lowest prices" refers to Macy's summer from May 1-July 31, 2014.



OPEN A MACY'S ACCOUNT FOR EXTRA 20% SAVINGS THE FIRST 2 DAYS, UP TO \$100, WITH MORE REWARDS TO COME. Macy's credit card is available subject to credit approval; new account savings valid the day your account is opened and the next day; excludes services, selected licensed departments, gift cards, restaurants, gourmet food & wine. The new account savings are limited to a total of \$100; application must qualify for immediate approval to receive extra savings; employees not eligible.

# The Law Offices of Georgia E. McCarthy



902 East 86 Street, Brooklyn NY 11236

## CONTESTED/UNCONTESTED DIVORCES

Aggressive Representation in Supreme Court and Family Court

## FAMILY LAW

## CHILD SUPPORT, CUSTODY, PATERNITY, VISITATION AND CHILD ABUSE

Protect Your Parental Rights in Family Court

## REAL ESTATE

Contracts & Closings, Foreclosures, Basement Ejections

## CRIMINAL MATTERS

## IMMIGRATION • BANKRUPTCY • ALL CIVIL MATTERS

## TRUST, WILLS & ESTATES REPRESENTATIONS



**Free Consultation**

Call 347-587-5458 • Fax 347-587-6169  
BY APPOINTMENT ONLY

# U.S. education system and immigrant parents

By Michelle Tullo

WASHINGTON, June 5, 2014 (IPS) - Immigrant parents in the United States face serious challenges accessing early elementary programmes for their children, advocates here are warning.

The centrality of parents in early childhood education is undisputed, yet a new report from the Migration Policy Institute (MPI), a Washington-based think tank, highlights a broad lack of programming for immigrant parents. The report lists gaps in translation services as well as cultural and systems knowledge for parents as primary obstacles, and notes significant potential impacts on children's education.

"With one in four young children in the United States living in an immigrant family, efforts to build trust and establish meaningful two-

way communication with these families is an urgent priority," states the report, released this week.

In recent years, U.S. policymakers have increased efforts to improve early childhood education. In January 2013, for instance, President Barack Obama introduced his Plan for Early Education for all Americans, which focuses on children to age five and includes funding high-quality preschool for all low- and moderate-income children.

Yet plans like this and others often overlook the importance of supporting immigrant parents, especially those with limited English-language proficiency. MPI's researchers warn that fast-changing demographics in the United States are making this oversight increasingly problematic.

"Immigration for the

longest time had been a five-state issue, but now it's a 40-state issue," Margie McHugh, one of the report's authors, said at a briefing Monday.

Of the one in four young children in the U.S. with immigrant parents, 45 percent are low-income, and their parents are twice as likely as native-born parents to have less than a high school diploma.

"This represents a significant risk factor for many young children of immigrants," the report states, "given that maternal educational attainment is closely linked with education outcomes for children, and parental education is closely linked with family earnings and economic well-being."

### BUDGET VICTIMS

Currently, no federal programme exists to explicitly  
Continued on Page 22

# URGENT CARE & WALK IN CLINIC

Mon – Fri: 9am to 8pm • Sat & Sun 12pm to 5pm

## No Appointment Necessary

"Why Wait for 5 hrs in an E.R when you can be seen by Quick Docs in 15 min. Guaranteed"

Board Certified Emergency Medicine Doctors Same as Kings County & Brookdale Hospital ER!

Referrals From Physicians and Attorneys Welcome



- Internal Medicine
- Acute Trauma
- Pediatrics
- Urgent GYN
- Physical Therapy
- Chiropractics
- Acupuncture
- Modern Facilities
- Onsite X-Ray
- Onsite Blood Draws

- Most Insurance Accepted
- We accept all types of payments
- Workman's Comp
- Car accident, Slip & Fall

**VISIT US TODAY!!**

• No Insurance, No Problem

**WE OPEN SUNDAYS**



All Major Credit Cards Accepted

255 East 98<sup>th</sup> Street • Brooklyn, NY 11212  
PH. 718-240-2644 Fax: 718-240-2676  
www.urgentcareinbrooklyn.com

Chiropractic and acupuncture treatments are offered by independent practitioners. By coming to the facility you are not obligated to see other practitioners on premises. While you may be referred for studies and/or consultations by other specialists you are free to follow up with the consultants or diagnostic facilities of your choice.

# WEDDING BANQUETS

and all

# SOCIAL FUNCTIONS

Featuring *Brand New*

*Caribbean Menu*



Let Us Create  
The Perfect Wedding  
For You  
At Affordable Prices

## Glen Terrace

DISTINCTIVE CATERING

**252-4614**

SERVING BROOKLYN FOR OVER 55 YEARS

VALET PARKING

**5313 AVE. N** Bklyn

(Between E. 53rd & E. 54th St.)



KINGSBOROUGH COMMUNITY COLLEGE

# CONTINUING EDUCATION

# SUMMER 2014

If you're considering a career change, seeking professional advancement or simply looking to enrich your life, Kingsborough's Continuing Education program has a course to fit your needs.

**Registration now in progress.**

Call **(718)-368-5050** to register.

Kingsborough Community College/CUNY  
Office of Continuing Education  
2001 Oriental Boulevard, Brooklyn, NY 11235  
www.kingsborough.edu

**CUNY** The City  
University of  
New York

# PORTABELLA

## FATHER'S DAY SUMMER SALE



**BUY 1 SUIT**

AT THE VALUE PRICE

**GET 2 FREE**

Or Buy 1 At Our Everyday Low Price

	Value	Everyday	NOW!
New Slim Fit	\$250	\$99 <sup>99</sup>	3 for \$250
New Vested Suits	\$300	\$129 <sup>99</sup>	3 for \$300
Luxury Wool	\$425	\$159 <sup>99</sup>	3 for \$425

**TUXEDO  
RENTALS**  
from \$49.99

BOYS • PROMS • WEDDINGS

**SUITS \$59<sup>99</sup>**

**THE BEST GIFTS FOR DAD**



**POLOS & T-SHIRTS**  
Large Selection  
FROM **\$9<sup>67</sup>**



**DRESS SHIRT & TIE SET**  
Save 60%  
FROM **\$24<sup>99</sup>**



**CASUAL SHIRTS**  
Plaids & Solids  
FROM **\$17<sup>99</sup>**



**TUXEDOS**  
Basic & Fashion  
FROM **\$79<sup>99</sup>**



THE LARGEST SELECTION IN NEW YORK

# SHOES

**\$19.99 \$29.99 \$39.99**

Driving • Dress • Tuxedo • Fashion  
Boys • U.S. Polo • Coogi  
Clarks • Florsheim • Kenneth Cole

Special Purchase  
**SANDALS**  
**\$9.67**



# PORTABELLA

### BROOKLYN

503 Nostrand Ave. - Portabella  
320 Livingston - Portabella  
1671 Pitkin Ave. - Portabella  
5205 5th Ave. - Portabella  
423 Knickerbocker Ave. - Portabella  
294 Utica Ave. - Portabella  
1555 Flatbush Ave. - Portabella  
851 Flatbush Ave. - Portabella  
552 Nostrand Ave. - Fino  
469 Fulton St. - Fino  
5007 Church Ave. - Fino

### QUEENS

163-18 Jamaica Ave. - Portabella  
3056 Steinway St. - Portabella  
164-08 Jamaica Ave. - Fino  
Queens Center - Quails  
Green Acres - Quails  
**NEW JERSEY**  
174 Main St. Paterson - Portabella  
807 Broad St. - Portabella  
Livingston Mall - Quails  
Woodbridge Center - Quails  
5516 Bergenline Ave. - Quails  
Freehold Raceway Mall - Quails

### BRONX

845 White Plains Road - Portabella  
12-20 E. Fordham Rd. - Portabella  
2887 3rd Ave. - Portabella  
3449 Jerome Ave. - Portabella  
2938 3rd Ave. - Fino  
345 East Fordham Rd. - Fino  
259 E. Fordham Rd. - Britches  
645 E. Tremont Ave. - Britches  
1498 Parkchester Ave. - Portabella  
Bay Plaza Shopping Center - Portabella  
13 South 4th Ave. - Mount Vernon

### MANHATTAN

243 W. 125th St. - Portabella  
617 W. 181 St. - Portabella  
120 W. 125th St. - Fino  
1405 St. Nicholas Ave. - Fino  
Manhattan Mall - Portabella

All merchandise not in all stores. All savings off value prices while quantities last. Sale prices effective through June 15th.

# FPWA recognizes June as Safety Month

By The Federation of Protestant Welfare Agencies

Each June, the National Safety Council celebrates National Safety Month as an opportunity to bring attention to important safety issues including preventing slips, trips and falls. The Federation of Protestant Welfare Agencies (FPWA) recognizes programs and community-based organizations throughout New York City serving vulnerable older New Yorkers that provide them with injury prevention strategies and instruction so they may live safely in their homes.

Older adults are at a much higher risk of unintentional injury and even death than the rest of the population. Seniors experience at least 6 million medically treated injuries and more than 30,000 deaths every year. Additionally, one out of every three older adults falls every year, but less than half actually speak to their health-care provider about it.

"National Safety Month is the optimum time to highlight programs that are designed to educate seniors how to remain injury free," states Kathleen Fitzgibbons, senior policy analyst for Elderly Welfare and Youth Services, Federation of Protestant Welfare Agencies (FPWA). "It is imperative that older adults have continued guidance and support from trained social service professionals on ways to live safely and comfortably within their communities so that

they may have continued prosperity and stability," continued Fitzgibbons.

"Heights and Hills's mission is to promote successful aging in the community. Our services focus on keeping elders safe and independent in their homes," says Judy Willig, executive director of Brooklyn-based Heights and Hills. "Our case managers perform in-home assessments to determine how we can best support each senior so they can avoid injuries. Our goal is to identify and remove barriers that impede the older adults' safe functioning in their environment," continued Willig.

"Preventing injury among the older individuals we serve is of paramount concern to Search and Care," reports Susan Siroto, program director for the agency which serves Harlem residents. "Search and Care offers a multi-tiered case management model where seniors are fully assessed. Our care managers, work with occupational therapy interns to help many of our elders remain safe and independent with falls prevention initiatives including shower safety treads, reviewing and adjusting home lighting, and teaching chair ergonomics. Additionally, at our upcoming symposium, a doctor from The Center for Health and Healing will be speaking with 250 community elders about balance and safety in a panel segment entitled "Put Your Best Foot Forward," notes Siroto.

# Fed student loan repayments

By Chudi Chukwudi

President Obama declared 2014 a year of action – vowing to use the power of his pen and phone to help ensure that hardworking Americans have the opportunity to succeed. And this week will be no different. With a focus on supporting hardworking Americans and upholding our country's commitment to provide a quality education for all of our students, the president is again taking action. Today, he will deliver remarks at the White House, announcing new executive actions to further lift the burden of crushing student loan debt, including a Presidential Memorandum that will allow an additional five million borrowers with federal student loans to cap their monthly payments at just 10 percent of their income. A fact sheet detailing these new steps is below.

Tomorrow the president will do a live Q and A with Tumblr, answering questions directly from consumers across the country about this crucial issue. At both of those events, and throughout this week ahead of their upcoming vote, the President will use every opportunity to urge Congress to do their part by passing Senate Democrats' bill to help more young people save money by refinancing their federal student loans.

From reforming the student loan system and increasing Pell Grants to offering millions of students the opportunity to cap their monthly student loan payments at 10 percent of their income, making a degree more affordable and accessible has been a long-time priority for the President. But he knows there is much more work to do and that's what this week is all about.

## Presidential Fact Sheet

A postsecondary education is the single most important investment that Americans can make in their futures. Higher education results in higher earnings and a lower risk of unemployment, but for too many low- and mid-

dle-income families this essential rung on the ladder to opportunity and advancement is slipping out of reach. Over the past three decades, the average tuition at a public four-year college has more than tripled, while a typical family's income has barely budged. More students than ever are relying on loans to pay for college. Today, 71 percent of those earning a bachelor's degree graduate with debt, which averages \$29,400. While most students are able to repay their loans, many feel burdened by debt, especially as they seek to start a family, buy a home, launch a business, or save for retirement.

The president and his Administration have a long track record of taking steps to make college more affordable and accessible for families. And as part of his year of action to expand opportunity for all Americans, the president is committed to building on these efforts by using his pen and his phone to make student debt more affordable and more manageable to repay.

Today the president will use the power of his pen to help millions of borrowers afford their student loan payments. He will sign a new Presidential Memorandum directing the Secretary of Education to propose regulations that would allow nearly 5 million additional federal direct student loan borrowers the opportunity to cap their student loan payments at 10 percent of their income. The Presidential Memorandum also outlines a series of new executive actions aimed to support federal student loan borrowers, especially for vulnerable borrowers who may be at greater risk of defaulting on their loans.

Today the President will also reiterate his call for the Senate to pass legislation that could help an estimated 25 million Americans refinance outstanding student loans at lower interest rates, the same as those available to federal student loan borrowers taking out

loans this year. This move could save a typical student \$2,000 over the life of his or her loans.

The Challenge of Student Debt: The challenges of managing student loan debt can lead some borrowers to fall behind on their loan payments and in some cases even default on their debt obligation, with such consequences as a damaged credit rating, losing their tax refund, or garnished wages. Because credit ratings are increasingly scrutinized in making employment offers, financing a home, or even opening a bank account, a damaged credit rating can further reduce borrowers' ability to repay their loans. Today's actions build on the Administration's significant progress in creating flexible repayment options for borrowers and raising awareness about the steps borrowers can take to responsibly manage their debt.

Capping Student Loan Payments at 10 Percent of Income: Today, the president will direct the secretary of Education to ensure that student loans remain affordable for all who borrowed federal direct loans as students by allowing them cap their payments at 10 percent of their monthly incomes. The Department will begin the process to amend its regulations this fall with a goal of making the new plan available to borrowers by December 2015.

With legislation passed by Congress and signed by the president in 2010 and regulations adopted by the Administration in 2012, most students taking out loans today can already cap their loan payments at 10 percent of their incomes. Monthly payments will be set on a sliding scale based upon income. Any remaining balance is forgiven after 20 years of payments, or 10 years for those in public service jobs. However, this Pay As You Earn (PAYE) option is not available to students with older loans (those who borrowed before October 2007 or who have not borrowed since October 2011), although they can access similar, less generous options.

# Caribbean Life

Founded 1990 • Published by Community Newspaper Group  
Corporate Headquarters: One MetroTech Center North, Suite 1001, Brooklyn, NY 11201

NEW YORK PRESS ASSOCIATION  
**NYPA**

**PUBLISHER:** Clifford Luster  
**ASSOCIATE PUBLISHER:** Ralph D'Onofrio  
**EDITOR-IN-CHIEF:** Kenton Kirby  
**ASSOCIATE EDITOR:** Kevin Williams

**Contributing Writers:** Azad Ali, Roderick J. Broome, Fabian Burrell, Tangerine Clarke, Robert Elkin, Patrick Horne, Nelson King, Donna Lamb, Tequila Minsky, Vinette K. Pryce, George H. Whyte, Bert Wilkinson, Lloyd Kam Williams

**GENERAL INFORMATION (718) 260-2500**

This newspaper is not responsible for typographical errors in ads beyond the cost of the space occupied by the error. All rights reserved. Copyright © 2014 by Courier-Life, Inc., publishers. Caribbean Life is protected by Federal copyright law. Each issue of Caribbean Life is registered with the Library of Congress, Washington, D.C. The Caribbean Life, its advertisements, articles and photographs, may not be reproduced, either in whole or part, without permission in writing from the publisher except brief portions for purposes of review or commentary consistent with the law.

**LETTERS TO THE EDITOR** are welcome from all readers. They should be addressed care of this newspaper to Kenton Kirby, Editor, Caribbean-Life Publications, 1 MetroTech Center North, Brooklyn, New York 11201, or sent via e-mail to caribbeanlife@cnglobal.com All letters, including those submitted via e-mail, MUST be signed and the individual's verifiable address and telephone number included. Note that the address and telephone number will NOT be published and the name will be published or withheld on request. No unsigned letters can be accepted for publication. The editor reserves the right to edit all submissions.

# Possibly hinting at bold new leadership

As President Obama keeps plugging away, trying to navigate a divided Congress -- the most daunting of challenges, with House Republicans, in particular, uniformly committed to non-cooperation -- there's no end, correspondingly, to the pile-on of banner issues from which GOP obstructionists hope to reap political pay dirt. As we've noted here previously, the Affordable Care Act's place in the pile as a major Obama-bashing gift has evidently been revised dramatically downward, now that going harshly negative on the health care fix has been shown to have serious backfire potential. But there remain a lot more on which Republicans pin hopes to score campaign points -- the well-worn Benghazi story, alleged IRS targeting of conservative groups, mismanagement at the V.A. and all the rest.

In wake of the latest brouhaha for which the president earned himself some more GOP poison darts, the p.o.w swap involving Army Sgt. Bowe Bergdahl, after a professional colleague and good friend shared with me some cogent analysis about how full of bias and hypocritical was the Republicans' pummeling of the president for authorizing the swap,

my rejoinder was that such detailed critique was wasted on Republicans' stock reflex-action response to the Bergdahl story. It suffices to simply know this: Had George W. Bush taken precisely the same action Obama did, there would be nothing but hosannas from the GOP chorus.

Automatic rejection by Republicans of practically every initiative Obama has undertaken, even those which in another life had strong Republican legs, leaves absolutely no doubt, of course, as to what would befall an issue known to be pure acid in GOP country... among some Democrats too, one would imagine. No wonder that the president has so far refrained from acting on a suggestion reportedly pitched to him by his former secretary of state.

Among the tidbits leaked in the lead-in tease before release of the new Hillary Clinton memoir, "Hard Choices," was that as secretary of state, she suggested to President Obama that he consider lifting the embargo on Cuba -- clearly, for us, head and shoulders above anything else heard from the Amen corner attributed to Secretary Clinton. Interesting, the source of this "dare-

## Viewpoint

By Les Slater

devil" conjecture. Only because we have always felt that Bill Clinton, one of the smartest guys to have occupied the White House in many moons, surely must have been convinced, while in the role, that ritualistic perpetuation of an embargo almost unanimously opposed elsewhere around the world, had to be senseless. And that if he had his druthers, he would have himself floated the idea that this relic of the Cold War era be forthwith retired.

Only, lest we forget, maybe not with quite the venom and depths of ugly that the racial component has laid bare with the sitting president, but Clinton had an army of full-time haters as well with which to contend. He too, like the current guy, was considered a White House interloper, by the elitist bunch who long ago assumed the self-styled mantle of "guardianship" of the Republic. So President Clinton, if ever he flirted with the notion of rattling the cages of charac-

ters hell bent on maintaining the Cuba embargo till kingdom come, probably considered the costs and promptly switched channels.

But now the Clinton camp draws our attention again on this nettlesome Cuba conundrum...at least for those forcibly beholden to a policy they know to have long outlived any usefulness. Do the sentiments Hillary says she conveyed to the president on Cuba reflect a strongly felt policy position she would herself pursue if given the opportunity? And what, in the way of strategy, would she bring to the table that would make a U.S. shift in Cuba policy a more viable prospect?

We've been for all these years in the vice grip of a tail-wagging-dog equation with respect to Cuba, where a small vested interest has exerted disproportionate national influence on how the U.S. engages Cuba. While in some quarters it's seen as making good political sense for America to respond to Cuba today the way the Kennedy administration did back then, there's increasing evidence that a lot more Americans aren't of that view. There has been polling indicating a shift in attitudes, surprisingly even among residents

in the Cuban-American stronghold in Florida. A survey published by the Atlantic Council registered 64 percent support for ending the embargo in that part of Florida. At some point, numbers have got to stand for something. In addition to poll numbers, there's the emphatic message annually sent to the U.S. by the UN General Assembly where, this country has recently had but a solitary assist from Israel against the tidal wave of disapproval from the world community, whenever the embargo question is up for a vote.

Although many have concluded that Hillary Clinton has already decided to be a candidate in 2016, she insists she has not. One doesn't want to read too much into her having broached the Cuban embargo question to the president, but it's foolhardy all the same to treat it lightly. If she is committed to making that 2016 run, and if she is fully prepared to have the Cuban embargo conversation despite stick-in-the-mud sound and fury from the usual suspects, she has already earned plaudits from those of us flabbergasted by America's confounding insistence on being embarrassingly out of step.



## IT PAYS TO GET THE ORDER RIGHT.

PICK ANY FOUR NUMBERS 0-9, CHOOSE THE ORDER YOU WANT THEM IN AND SAY "PLAY IT STRAIGHT" TO WIN UP TO \$5,000.



NYLOTTERY.NY.GOV

© 2014 NEW YORK LOTTERY. Please Play Responsibly. You must be 18 years or older to purchase a Lottery ticket.



# McManus

## FUNERAL HOME



On Site Parking • Large Chapels & Lobby • Worldwide Shipping

OUR SUMMER 2012 INTERIOR RENOVATION IS COMPLETE

*Before choosing a funeral home  
We invite you to visit our newly decorated chapels  
And compare our affordable pricing and dedicated service*

**718-377-5200 • www.mcmanusfh.com**  
4601 Avenue N (at E. 46 St.) • 1 Block off of Flatbush Ave.



Caribbean Life Editor Kenton Kirby, accepts QFT excellence award on behalf of the newspaper.  
Photo credit: Anthony Hangas

# Journey to Excellence Ceremony in Queens

## Faith Temple Church honors the local press

**By Kimmy-Roux James**

Looking from the outside, the white stucco building framed with a chrome-gated entrance seems nothing more than a building wedged on a busy street. But looking up to see a cross, it would be clear that the building is a church. Inside, there's a relatively small, furnished hall with 200 plush, red chairs, and an adjoining room -- separated by a glass-enclosed wall, for additional seating.

On Saturday, June 7, the church -- named Queens Faith Temple of Seventh-day Adventists (QFT), hosted a special Education Day celebration themed: "The Journey to Excellence."

Around 11 a.m., the church sanctuary is near seating capacity, while a Bible study program wraps up and is followed by announcements. The celebration began with 18 graduates, dressed in blue and yellow regalia, marching down the church's aisle to be seated in the first three rows. With all the pomp and circumstance, there is an air of pride and joy that fills the church.

"This is a special day!" said Pastor Clyde Thomas, program coordinator of the

special event. "We are here to honor the achievements our graduates have attained and inspire others to reach their educational pursuits."

For an hour, graduates from kindergarten to university status were individually and collectively recognized with a medal of honor or awarded with a bronze-plated plaque.

"I almost welled up with tears receiving so many touching messages from my church members," said Ms. Jellisa Grant, a recent college graduate. "I really love my church and the support they have given me through my years of study."

Ms. Grant graduated with honors and plans to become an attorney.

"No matter how smart you are, put God first and allow him to lead your life," said Dr. Waitline Williams, who shared her story of earning her doctorate in nursing.

Other notable mention were given to two Adventist Education institutions: Greater New York Academy and Northeastern Academy, for their continued commitment to Christian education. In addition, members from the community, including New York's Carib-

bean Life newspaper and the Queens Press were specially recognized for their media services to the Queens community.

The sermon was preached by 12-year-old, Charles Clarke, and 11-year-old, Anthony Trim, taking turns on the topic: "Go for the Goal!" Each delivered inspiring 20-minute messages about athletes who had to overcome defeat on their journey towards the achievement a higher education.

"One day, when they're all grown up," said Pastor Thomas, referring to the two young men, "they'll look back on this moment and remember that we, as a church body, took the time to cherish and devote our time to honor their hard work in school and the community."

Queens Faith Temple is a faith community rooted in the beliefs described by the Holy Scriptures. Programs like the Education Day celebration are hosted once a year. The church is located at 217-03 Merrick Boulevard, Springfield Gardens, NY. To learn more about QFT, visit: [www.queens-faithtemple.org](http://www.queens-faithtemple.org).

## OUR PHYSICAL THERAPISTS ARE AMONG THE BEST IN THE BUSINESS

### We Do House Calls

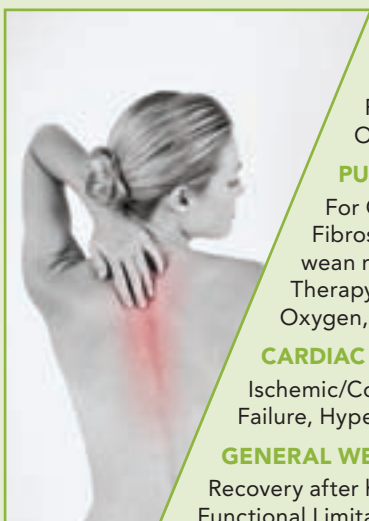

#### SPINE AND JOINT CARE

Disk Bulge and Disk Herniations, Stiffness, Acute and Chronic Pains, Muscle Spasms, Rehabilitation prior or after neuro and/or Orthopaedic surgery for joints or spine.

#### PULMONARY REHABILITATION

For COPD, Sarcoidosis & Interstitial Pulmonary Fibrosis, our Pulmonary Rehab Specialist could wean many patients from supplemental Oxygen Therapy and live normal life without Supplemental Oxygen, Respiratory Failure, type 1 & 2.

#### CARDIAC REHABILITATION

Ischemic/Coronary Heart Disease, Arrhythmias, Heart Failure, Hypertension and rehab after Heart surgery.

#### GENERAL WEAKNESS

Recovery after hospitalization or surgery, Muscle Weakness, Functional Limitation, Restoring day to day activities.

We also provide pelvic floor rehabilitation for stress incontinence.  
We treat all ages & accept all Major Health Insurances.



**Integrated Rehab and  
Physical Therapy P.C.**  
*We treat you like family.*

2657 Batchelder Street  
Brooklyn, NY 11235

**(718) 332-3401**

[www.integratedrehabandphysicaltherapy.com](http://www.integratedrehabandphysicaltherapy.com)

FAX (646) 719-8631

IntegratedRehabandPhysicalTherapy EMAIL [info@integratedrehabandphysicaltherapy.com](mailto:info@integratedrehabandphysicaltherapy.com)

Real Wood Craftsmanship.  
Made in NY since 1969.

**GOTHIC LIFE  
LIFETIME  
WARRANTY**

**gothic furniture**  
The Original Gothic Cabinet Craft

Proudly Made  
in New York!



**QUEENS  
FACTORY OUTLET  
& Clearance Center  
MASPETH**  
58-77 57 Street  
(Corner Grand Ave.)  
(347) 881-1458

**ASTORIA**  
28-49 Steinway Street  
(718) 932-0830

**JAMAICA  
FACTORY OUTLET  
& Clearance Center**  
148-02 Jamaica Avenue  
(718) 297-1109

**OZONE PARK**  
100-02 Rockaway Blvd.  
(718) 641-4767

**BAYSIDE/FLUSHING**  
191-22 Northern Blvd.  
(718) 321-3757

**JACKSON HEIGHTS**  
82-16 37th Ave. (718) 426-6622

**MANHATTAN**  
1646 2nd Ave. (Bet. 85 & 86 St.)  
(212) 472-7359

104 3rd Ave. (Cor. 13th St.)  
(212) 420-9556

2652 Broadway (Bet. 100 &  
101 St.) (212) 678-4368

195 Lexington Ave. (32nd St.)  
(212) 252-8478

**BRONX**  
2366 University Ave.  
(Corner Fordham Rd.)  
(718) 365-9333

2157 White Plains Rd.  
(near Pelham Pkwy.)  
(718) 863-7440

2011 Westchester Ave.  
Parkchester (718) 239-4667

**BROOKLYN  
KINGS PLAZA**  
2494 Flatbush Avenue  
(718) 677-0070

**EMPIRE BOULEVARD**  
160 Empire Blvd.  
(718) 703-8722

**BORO HALL**  
31 Smith St. (nr. Fulton)  
(718) 625-2333

**BAY RIDGE**  
6929 5th Avenue  
(nr. Orvington Ave.)  
(718) 745-0715

**LONG ISLAND  
RIVERHEAD**  
1076 Old Country Road  
(631) 461-3225

**FREEPORT**  
244 East Merrick Rd.  
(516) 223-2590

**ISLIP/BAYSHORE**  
609 E. Main St. (631) 969-2203

**CARLE PLACE**  
245 Old Country Rd  
(516) 333-5560

**FARMINGDALE**  
2119 Broad Hollow Road  
(Rt 110) (516) 777-7580

**WOODMERE**  
253-01 Rockaway Blvd.  
(5 Towns Shopping Ctr.)  
(516) 791-7072

**WESTCHESTER  
YONKERS  
FACTORY OUTLET  
& Clearance Center**  
636 S. Broadway  
(914) 709-0019

**YONKERS**  
2361A Central Park Ave.  
(914) 337-2685

**ELMSFORD**  
15 E. Main St. (Corner of Rte.  
9A & 119) (914) 345-6161

**STATEN ISLAND**  
1756 Forest Ave. (at Richmond  
Avenue in Shoprite Shop Ctr.)  
(718) 477-6363

# SOLID SAVINGS

## ON REAL WOOD MADE IN NY FURNITURE!

**THE ORIGINAL SOLID PINE CAPTAINS BED**  
WITH UP TO 6 EXTRA DEEP DRAWERS OF STORAGE.  
Made Locally in New York & Available in  
20 colors or buy unfinished & Save!



IN A CHOICE OF ANY OF OUR CLASSIC FINISHES!\*

**CAPTAINS BED** w/ 3  
Drawers Twin Size #TCB-P **\$199** or buy it unf. only \$149

**CAPTAINS BED** w/ 3  
Drawers Full Size #FCB3-P **\$449** or buy it unf. only \$349

**CAPTAINS BED** w/ 6  
Drawers Queen Size #QCB6-P **\$549** or buy it unf. only \$449

**BOOKCASE HEADBOARD** Twin Size #87T36-P STARTING AT \$119  
**MATTRESS** Twin Size #3400T STARTING AT \$179



ONLINE  
EXCLUSIVE

**DAY BED** with Hidden Trundle in a  
Soft Padded Leatherette Material. Avail.  
in a Choice of 3 Colors: Espresso, Grey  
& Red. Twin/Twin #ACM1956-SP Reg \$599  
**ON SALE  
NOW ONLY  
\$379**

**DOUBLE DUTY  
FURNITURE IS WHAT  
WE ARE ABOUT. OUR  
VERSATILE PIECES CAN  
BE USED IN ANY ROOM  
IN YOUR HOME!**

**A. #WU2D16-B UNIT**  
w/ 2 Doors & 4 Adj.  
Shelves 16D  
x 32W  
x 84H **\$419**

or buy it unf. only \$349

**B. #WU3D16-B UNIT**  
w/ 3 Drawers on Tracks  
& 3 Adj. Shelves 16D  
x 32W  
x 84H **\$459**

or buy it unf. only \$389



**HAND MADE IN NEW YORK, THE ORIGINAL  
SOLID PINE STORAGE BED**  
with up to 12 Drawers of  
Extra Deep Storage.



IN A CHOICE OF ANY OF OUR CLASSIC FINISHES!\*

**SOLID PINE STORAGE  
BED** w/ 6 Drawers on  
Tracks Twin Size #TSB60T-P **\$499** or buy it unfinished only \$419

**SOLID PINE STORAGE  
BED** w/ 12 Drawers on Tracks  
Full or Queen Size #SB120T-P **\$949** or buy it unfinished only \$749



OVER  
30%  
OFF

CLICK  
OUR "ONLINE  
EXCLUSIVES" TAB

**URBAN FULL OR QUEEN SIZE BED**  
in a Padded Leatherette Material. Avail.  
in 3 Different Colors: Grey, White &  
Espresso. #ACM7008-SF Reg \$270  
**ON SALE  
NOW ONLY  
\$179**

**SOLID PINE 2  
PIECE DESK &  
HUTCH SET**  
w/ 4 Adjustable  
Shelves & 4  
Drawers on  
Tracks (1 File)  
21D x 42W x 78H  
#SET2P-DH42  
IN A CHOICE  
OF ANY OF  
OUR CLASSIC  
FINISHES!\*

**\$599**

or buy it unf.  
only \$469

Desk also sold  
separately  
STARTING  
AT \$299



**REAL WOOD BIRCH BOOKCASES  
WITH ADJUSTABLE SHELVES.**

**A. BIRCH BOOKCASE**  
w/ 2 Adj. Shelves 12D  
x 30W x 30H #GR20-B **\$179** or buy it unf. only \$129

**B. BIRCH BOOKCASE**  
w/ 3 Adj. Shelves 12D  
x 30W x 48H #GR21-B **\$199** or buy it unf. only \$139

**C. BIRCH BOOKCASE**  
w/ 4 Adj. Shelves 12D  
x 30W x 60H #GR22-B **\$249** or buy it unf. only \$179

**D. BIRCH BOOKCASE**  
w/ 5 Adj. Shelves 12D  
x 30W x 72H #GR23-B **\$289** or buy it unf. only \$209

**E. BIRCH BOOKCASE**  
w/ 6 Adj. Shelves 12D  
x 30W x 84H #GR24-B **\$329** or buy it unf. only \$239

**10%  
OFF  
ANY ORDER  
INCLUDING GOTHIC'S  
POPULAR FINISHES\***

COUPON CODE "10CLO612" USE IN STORE  
OR ONLINE! SALE ENDS 06/22/14

**REAL WOOD BIRCH "DOUGLSTON" COLLECTION BEDROOM PIECES DESIGNED FOR MAXIMUM  
STORAGE AND DURABILITY**

**A. NIGHTSTAND**  
w/ 2 Drawers on Tracks  
18D x 24W x 24H #SNSD24-B **\$199** or buy it unf. only \$159

**B. CHEST**  
with 6 Drawers on Tracks  
18D x 24W x 62H #SCG024-B **\$419** or buy it unf. only \$359

**C. DRESSER**  
w/ 8 Drawers on Tracks  
18D x 45W x 43H #SD8D45-B **\$519** or buy it unf. only \$449

**Buy the Chest or Dresser and  
Get Any Discontinued Mirror for FREE**

**OUR "FLAT IRON" COLLECTION MODULAR CLOSET  
SYSTEM LETS YOU CONFIGURE EXACTLY THE  
CLOSET YOU NEED. CHOOSE FROM 7 DIFFERENT  
PIECES AND BUILD YOUR OWN.**

**REAL WOOD BIRCH CONSTRUCTION.  
DRAWERS ON GLIDES. MADE IN NEW  
YORK. LIFETIME WARRANTY.**

**A. DOUBLE WARDROBE** with 3  
Drawers on Tracks & Hanging Rod  
24D x 36W x 72H #PDWGR39-B **\$669** or buy it unf. only \$539

**B. SLIM WARDROBE**  
with 4 Adjustable Shelves  
24D x 18W x 72H #PDW18RL-B **\$459** or buy it unf. only \$359

**2 PIECE SET ONLY \$1049**  
(#PDWGR39-B & #PDW18RL-B) or buy it unf. only \$849

**15%  
OFF  
ANY ORDER  
OVER \$1999**

INCLUDING GOTHIC'S POPULAR FINISHES\*  
COUPON CODE "15CLO612" USE IN STORE OR  
ONLINE! SALE ENDS 06/22/14



**LARGEST SELECTION  
OF BOOKCASES &  
WALL UNITS.  
LEXINGTON  
SERIES.**



**VISIT ONE OF OUR BROOKLYN LOCATIONS TODAY**

**KINGS PLAZA** 2494 Flatbush Avenue ..... (718) 677-0070

**EMPIRE BOULEVARD** 160 Empire Blvd. .... (718) 703-8722

**BORO HALL** 31 Smith St. (nr. Fulton)..... (718) 625-2333

**BAY RIDGE** 6929 5th Ave. (nr. Orvington Ave.)..... (718) 745-0715

Check our website for more locations **1-877-4-GOTHIC**

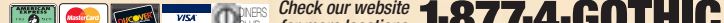

**SHOP OUR COMPLETE CATALOG ONLINE AT**

**gothicCabinetCraft.com**

\*Excluding Dark Teak, Dark Mahogany & Premium Finishes. Excluding mattresses, advertised sale items, lay-a-way orders, finance orders, custom orders & made to order finishes. Not valid for prior sales. In store specials and package deals excluded. Lifetime warranty on Gothic built furniture only. All products must be registered online for warranty. Visit us online for details or ask a sales associate for documentation. Installation and set-up fees may apply to some products. Delivery fees are not included in pricing. Photos, accessories and mattresses are not included and are for illustrative purposes only. Offers cannot be combined. While supplies last, not responsible for typographical errors. Not valid with any other offer. Sale ends 06/22/14.





**GRAB BROKEN FLASHLIGHT**



**GRAB EXPIRED FOOD**



**GRAB DEAD BATTERIES**



**GRAB THE CAT**

## **WINGING IT IS NOT AN EMERGENCY PLAN**

Make sure your family knows what to do during an emergency. Who to call. Where to meet. What to pack. Search Ready Kids at [NYC.gov](http://NYC.gov) or call 311.



**Walmart**   
Save money. Live better.

**NEWLY EXPANDED**  
Next To Green Acres Mall on Sunrise Highway

**Transfer &  
save.**



# COLLEGE FOR **kids** | SUMMER GROUP PROGRAM

The summer College For Kids program at Kingsborough Community College is open to girls and boys ages 7 through 13 and meets weekday Mornings for 4 weeks and Full Days for your choice of 4 or 6 weeks!

For information about our 5 & 6 year-olds program, please call 718-368-5050



This summers theme is the constellations!

Enroll your child in any of these six groups: TAURUS | ORION | GEMINI | PEGASUS | PISCES | LIBRA

Each group is full of exciting courses! SWIMMING | BASKETBALL & SOCCER | PIANO | TENNIS | READING | ART | MATH ...and much more!

Please call 718-368-5050 for more information and to register.

Or visit us online @www.kingsborough.edu/continuinged

KINGSBOROUGH COMMUNITY COLLEGE  
**CONTINUING EDUCATION**

Kingsborough Community College/CUNY  
Office of Continuing Education  
2001 Oriental Boulevard, Brooklyn, NY 11235  
www.kingsborough.edu



# Dr. Yvonne McCallum-Peters

By Nelson A. King

Dr. Yvonne McCallum-Peters was born and raised in the Caribbean Community (CARICOM) member-nation of Guyana.

She has earned a doctorate from Teachers College, Columbia University.

Dr. McCallum-Peters began her academic duty at Medgar Evers College, City University of New York (CUNY) in the fall semester of 1994.

She worked as a part-time Basic Education/GED instructor in the Continuing Education Department, now known as the Department of External Programs.

In the fall of 1998, Dr. McCallum-Peters became a full-time faculty member of the Post Secondary Readiness Center, now renamed Academic Foundations Division.

She has also been an adjunct faculty member of the English Department since 2000.

Before joining the Medgar Evers College faculty, Dr. McCallum-Peters



Photo shows Dr. Yvonne McCallum-Peters receiving community service award in Feb. 2014 from the Brooklyn-based APC Community Services, Inc. executives, President Dr. Janice Emanuel-Bunn and chairman Dr. Gordon John.

Photo by Nelson A. King

taught at the Borough of Manhattan Community College, CUNY, from 1985 until her full-time appointment at Medgar Evers College.

She has also been an adjunct assistant professor at Brooklyn College, where she continues to teach basic skills in the summer and winter programs.

## Healthy Gums And Teeth For A Lifetime!

# Gentle And Effective Treatment! St. Marks Painless Dental

### Painless Laser Treatment

If you are afraid, come to St. Marks Painless Dentistry. Say good-bye to painful needles and annoying drills. We are the first in the area to use a dental laser that, in most cases, eliminates the use of drills and needles. Amazing equipment and state-of-the-art methods will make your next dental visit enjoyable and stress free.

### IV Sedation (Sleep Dentistry)

Discover a whole new world of comfortable and painless dentistry. Our top priority is to eliminate your fears.

### Implants

Based on years of experience and a multitude of completed cases we strongly believe that it is most beneficial for a patient to have all stages of Implantology performed at one clinic. We will design your case, perform the surgery, insert your teeth and maintain them. It makes the whole process smooth, painless and affordable.

### Gum Treatment/Bone Grafting

We provide comprehensive periodontal treatment including bone grafting.

### Cosmetic Dentistry

• White fillings at no extra cost • Laser Bleaching (takes only one hour) • Bad breath treatment

### Orthodontic Treatment & Invisalign

We combine the best achievements of European and American orthodontics to eliminate unnecessary extractions. We proudly hold a status as a PREFERRED PROVIDER given to us by Invisalign.

### Dental Laboratory on Premises

Repair your old dentures while you wait.

Implants • TMJ Treatment (Jaw Joint) • Bridges • Root Canals



**FREE**  
INITIAL CONSULTATION  
Do Not Hesitate To Visit  
St. Marks Painless Dental

**St. Marks Painless Dental**  
907 St. Marks Ave.  
Bet. Albany & Kingston Aves.  
**718-778-3283**



*A Staff That Cares,  
Doctors Who Truly Listen  
And Treat With Love!*

LOW PROPERTY TAXES! EXPRESS COMMUTER BUSES (4 per hour) 90 mins to NYC!

# Yes, you can own a brand new home for just **\$1,577 per mo.!**\*

And just \$6,997 Down! Classic has the values! Call us now!

All Classic Mainline Homes include up to 4 bedrooms, 2½ baths, garage, living room, dining room, complete appliance package, Central Air and Heat, landscaping, and a host of features. including permitting, driveway and well -- all included in the purchase price!

THE COUNTRY HOME -- *A Classic Mainline Home*



**NOW \$199,900**

2,684 SQ. FT. • LARGE OPEN FOYER

**\$6,997 DOWN PAYMENT**

**\$1,577\*** per month pays all including principal, interest, taxes and insurance!\*

THE CAMBRIDGE -- *A Classic Mainline Home*



**now \$293,500**

3,393 SQ. FT.! • Your Palace in the Poconos!

**\$14,650 DOWN PAYMENT**

**\$1,953** per month pays all including principal, interest, taxes and insurance!\*

Choose from Classic's Complete Line of Brand New Homes in the Poconos!

**Buy a home now -- Get up to \$5,000 toward Closing Costs!**

**ALSO AVAILABLE -- Previously Owned Homes from just \$80,000**



Call toll free  
**1-800-  
276-4000**

\* Monthly payments based on FHA 30 yr. fixed interest rate of 4.5% with 5% APR with a finance cap of \$271,000. Lower rates may apply to qualified buyers. All numbers are estimated. Conventional mtgs. also available.



Visit our website: [www.classicqualityhomes.com](http://www.classicqualityhomes.com)  
Or text: cqh to 411669 to get text updates about our Home Buying Incentive programs

# IF YOU HAVE BEEN INJURED IN AN ACCIDENT... DISCRIMINATED AGAINST OR FALSELY ARRESTED

Come see us at the Law Office of  
**Vincent I. Eke-Nweke, P.C.**  
**WE CAN HELP YOU!!**



- **Personal Injury:**  
Motor Vehicle Accidents • Slip and Fall • Medical Malpractice • Construction Accidents and More!!
- **Employment Discrimination:**  
Sexual Harassment • Hostile Work Environment  
Age, Gender, Race & Military Status Discrimination
- **Civil Rights:**  
Police Brutality • False Arrest • False Imprisonment

**Contact Us At:**  
**498 Atlantic Avenue • 718 852-8300**  
**e-mail: vekenweke@aol.com • www.vekenwekelaw.com**

## CARIBBEAN ROUNDUP

Continued from page 2

in boxes containing peppers and ochroes at Piarco International Airport, Trinidad last month.

The Customs Anti-Narcotics Unit (CANU) of Guyana has issued wanted bulletins for the alleged suspects who have been identified as Caleb Habeeb Caesar, 30, of Newton, Guyana and Phillip Carlos Jermin Lovell, 37, of Guyhoc Park, Guyana.

Photographs of the wanted men have been posted in the newspapers in Guyana.

Guyana police said the quantity of cocaine was found hidden in boxes containing peppers and ochroes on a Caribbean Airlines flight which had earlier arrived in Trinidad from Guyana. The final destination of the flight was stated as New York.

There is concern over how the cocaine went unnoticed by Guyanese authorities and was allowed to slip through security at the Cheddi Jagan Airport.

### St. Vincent

Chairman of regional airline LIAT, Dr. Ralph Gonsalves, prime minister of St. Vincent and the Grenadines said a technical

committee will soon be established between management and workers to oversee the smooth and improved daily operations of the company.

He said the decision was made at a meeting last month between the chairman and shareholders committee and directors, the new chief executive officer and the union representing the workers across the region.



Dr. Gonsalves said the basis of the meeting was to review an eight-page document submitted by the unions representing workers, analyzing the failings of the company and provided recommendations for urgent measures to stem the downward spiral of the regional airline.

The document was submitted to the LIAT chairman in February.

The Vincentian prime minister said the new LIAT CEO David Evans presented a broad overview of his vision and "strategic frame" for the airline's future, which he plans to make available in detail to all LIAT shareholders, including workers.

*Compiled by Azad Ali*

Go to [www.Caribbeanlifeneews.com](http://www.Caribbeanlifeneews.com) for the latest in Caribbean news, entertainment, sports, business, viewpoints and more.

## + BROOKLYN MED

### THE MEDICAL DIRECTORY FOR BROOKLYN

#### ALLERGY & ASTHMA

Dr. Gadi Avshalomov, M.D.  
The Center for Allergy, Asthma, & Immunology.  
Board Certified in Adult & Pediatric Allergy & Asthma

2085 E 67th Street, Brooklyn, NY  
(718) 444-8014 • [www.allergyimmunologydr.com](http://www.allergyimmunologydr.com)

Dr. Stephen Rand - Kings Plaza Professional Center  
*Diplomate, American Board of Allergy, Asst. Clinical Professor of Medicine-SUNY Brooklyn.*  
*Pulmonary, Nasal & Allergy Testing Treatment*  
2270 Kimball Street, Marine Park, NY • (718) 377-0011

#### AUDIOLOGY

Liberty Hearing Centers  
*Specializing in Revolutionary Invisible Hearing Aid. Free Hearing Screenings*  
Bay Ridge: 9015 5 Ave. | Sheepshead Bay: 2204 Voorhies Ave.  
Flatbush: 445 Lenox Road • 1 (888) 337-5650

#### DENTISTRY

Dr. Joseph Lichter - Cosmetic & Family Dental  
1420 Ave. Brooklyn, NY 11229  
[www.JosephLichterDDS.com](http://www.JosephLichterDDS.com)

Dr. Barry Grossman  
*Mill Basin Cosmetic & Restorative Dentistry Fellow, Int'l Congress of Oral Implantologists*  
2135 Mill Ave. & 8919 Flatlands Ave., Brooklyn, NY  
(718) 531-7700 • [www.millbasindentists.com](http://www.millbasindentists.com)

765 Dental  
*Specializing in Extreme Smile Makeovers & Painless Dentistry*  
765 Nostrand Avenue, Brooklyn, NY  
718-307-5660

#### FAMILY PRACTICE

Camele White, M.D. - Family Physician  
*Adults, Children and Gynecology/Women's Health Services*  
385 Remsen Avenue, Brooklyn NY  
347-915-1755

#### INTERNAL MEDICINE

Dr. Martin Slavin, M.D.  
*Board Certified Internist with specialty in Testosterone Deficiency & Replacement Therapy*  
5601 Flatlands Ave., Brooklyn, NY  
(718) 444-7040  
[www.martinslavin.com](http://www.martinslavin.com)

Dr. Natalie A. Marks, M.D.  
*Internal Medicine/Vascular Medicine Specialist Director of the Vein Center of N.Y. Specializing in Varicose Veins.*  
960-50 Street, Brooklyn, NY 11219  
(718) 438-3800 • [www.vascularnyc.com](http://www.vascularnyc.com)

Dr. Zhanna Tsukerman  
514 Ocean Parkway, Brooklyn, NY 11218  
(718) 484-7040 • [www.doctortsukerman.com](http://www.doctortsukerman.com)

#### LASER INSTITUTE

Vitruvian Aesthetics  
*Skin rejuvenation, laser hair removal, cellulite reduction, laser foot care for men and women*  
8120 15th Ave., Brooklyn, NY 11228  
(917) 789-9911 • [www.Vitruvianaesthetics.com](http://www.Vitruvianaesthetics.com)

#### PAIN MANAGEMENT

Dr. Alfredo del Castillo, M.D. - The Pain Center  
9731 Fourth Avenue, Brooklyn, NY 11209  
(718) 966-8120

Dr. Rajesh Patel, M.D. FIPP, DABPM & Nityananda Podder, M.D.  
*Team of Interventional Pain Specialists*  
1815 Flatbush Ave., Brooklyn & 196-17 Hillside Ave., Queens  
(718) 479-3900 • [www.nypaindoc.com](http://www.nypaindoc.com)

#### PODIATRY

Santi Podiatry Group  
240 East Fifth Street, Brooklyn, NY  
(718) 435-1031  
[www.SantiPodiatry.com](http://www.SantiPodiatry.com)

Mario Voloshin DPM, AACFAS  
*Foot & Ankle Reconstructive Surgery*  
*Foot & Ankle Center of Mill Basin, Bergen Beach, and Georgetown*  
1584 East 66nd St., (Corner of Avenue U)  
(718) 444-7410  
[www.greenpointfootandankle.com](http://www.greenpointfootandankle.com)

#### RHEUMATOLOGY

Dr. Victoria Katz  
*Internal Medicine. Rheumatology & Pediatric Rheumatology*  
1664 E 14th St., Suite 401, Brooklyn, NY 11229  
71-36 110th St., Suite IJ, Forest Hills, NY 11375  
51 East 42nd St., Suite 1808, New York, NY 10017  
(718) 375-2300 • (212) 563-6020  
[www.victoriakatzmd.com](http://www.victoriakatzmd.com)

#### UROLOGY

New York Urologic Institute  
2270 Kimball Street, Suite 101A, Brooklyn, NY 11234  
110-11 72nd Ave., Forest Hills, NY 11375  
2632 E 14th St., Brooklyn, NY 11235  
(718) 878-3523 • [www.nyui.org](http://www.nyui.org)

#### VASCULAR

Dr. Enrico Ascher, M.D. -  
The Vascular Institute of NY  
960-50 St., Brooklyn, NY 11219  
(718) 438-3800  
[www.vascularNYC.com](http://www.vascularNYC.com)

#### WEIGHT LOSS

Conquer the Crave® Physician supervised weight loss program  
507 Chestnut Street, Cedarhurst, NY 11516  
(516) 295-7400 or (718) 285-8807  
[www.conquercraves.com](http://www.conquercraves.com)

# STILL TIME TO GET READY FOR SUMMMER!

## START NOW!



### LASER HAIR REMOVAL

Upper Lip.....	\$50
Chin.....	\$60
Under Arm.....	\$95
Brazilian Bikini.....	\$175
Full Back.....	\$250
Full Legs.....	\$250
Full Face.....	\$160

### LASER SERVICES

Full Face Titan (special).....	\$600
IPL-Full Face.....	\$250
Laser Genesis Full Face.....	\$200
Vein Removal.....	\$200
Full Neck Skin Titan (special)....	\$400

All prices are per session.

## LOSE 1-2 POUNDS OF FAT PER DAY USING OUR HEALTHY DIET PLAN

### Weight Loss Program - 50% OFF

All Natural Healthy Products (No Injections)

*Doctor Supervised*

Designed for your individual body

### Lipo Laser Special - 50% OFF

Non-surgical Painless (12 Treatments Recommended)

Lose 3-5 inches off your waist & other areas

### HOT SUMMER SPECIALS!

**Laser Hair Removal** - Underarm, Brazilian Bikini, Full Leg

\$400 per treatment

**3D Skin Rejuvenation of the Face**

\$2,500 (Savings of \$1,500) **Includes**

3 Titan Skin Tightening Treatments

3 IPL Sun Spot Removal Treatments

5 Laser Genesis Treatments

### FREE CONSULTATION WITH DR. DiGIUSEPPI

Dr. James A. DiGiuseppi

**Skin Beauty Laser Center**

7123 10th Avenue • Brooklyn, NY 11228

**718-833-0704 • [www.skinbeautylaser.com](http://www.skinbeautylaser.com)**



**MENTION THIS AD AND RECEIVE \$100 OFF YOUR FIRST TREATMENT OF LASER SERVICES**

# Clear need in the U.S. for SVG business

By Nelson A. King

Maxwell Haywood, president of the Brooklyn-based St. Vincent and the Grenadines Diaspora Committee of New York, Inc. has expressed delight about what he described as a very successful initial, special Diaspora business meeting last Saturday aimed at establishing a Vincentian American Chamber of Commerce.

Haywood, a United Nations social development officer, told Caribbean Life, in an exclusive interview, that the main Vincentian organizations in the Diaspora, with the capacity to initiate the project, are “fully” supportive of the initiative.

“I feel a sense of great accomplishment by our Diaspora to have managed to bring this idea this far,” said Haywood after the meeting at the Friends of Crown Heights Educational Center in Brooklyn, considered the primary gathering venue for most Vincentians and organizations in the “Big Apple.” “Our community is better off as a result of this successful meeting.

“I feel as if we are now on a path that, in many ways, could be irreversible in terms of setting a firm foundation for more wealth creation in our Vincentian community in the United



Maxwell Haywood, chairperson of the Diaspora Committee addressing the special Diaspora business meeting last Saturday.

Photo courtesy of SVG Diaspora Committee of New York, Inc.

States,” he added. “This has great implications for the development process in St. Vincent and the Grenadines and the Vincentian Diaspora.”

Haywood said the meeting, convened in partnership with the Brooklyn-based umbrella Vincentian group in the United States, Coun-

cil of St. Vincent and the Grenadines Organizations, U.S.A., Inc. (COSAGO), and the New York Consulate General, attracted about 30 delegates.

He said the meeting achieved the objectives of presenting the case for a Vincentian business organization in the United States,

hearing the views of the Vincentian business persons in the U.S. and establishing a Steering Committee.

Eight nationals were nominated to lead the Steering Committee, Haywood said. They comprise: Vaughn Toney, president and chief executive officer of the Friends of Crown Heights Educational Centers, Inc.; lawyers Curlina Edwards and Colin Liverpool; educator Dr. Atiba Weza; businesswoman Joanne Legair; insurance executive Judy Marksman; medical supplies personnel Michelson Mclean; and accountant Andre Bailey.

Haywood noted that the Vincentian Diaspora in the field of business has a “long history” in the U.S.

“All along, it was always the view of most people that more could be done in the Diaspora to promote the growth and development of Vincentian-owned businesses in the U.S.A.,” he said.

“There is a clear need in the U.S.A. for the Vincentian business owners, Vincentian business professionals and Vincentian business students to come together on a constant basis to address issues and opportunities before them, and to come up with solutions that the entire Diaspora community in the U.S.A. and SVG

(St. Vincent and the Grenadines) could rally around,” he added.

Furthermore, Haywood said the business sector in St. Vincent and the Grenadines has expressed interest in working together with Vincentians living abroad in promoting the business interest of Vincentians at home and those in the Diaspora.

He also pointed to the formulation of ideas and proposals in the business section of the Diaspora Framework for Action, which emerged from the St. Vincent and the Grenadines Diaspora Conference of 2009.

One of those proposals is the creation of a “Vincentian Business Association in the Diaspora,” Haywood said.

He said the initiative is to empower Vincentian-owned businesses in the U.S.

“It will enhance the process that would establish of a strong Vincentian platform or umbrella organization – Vincentian Chamber of Commerce in the U.S.A./ Vincentian Business Association in the Diaspora,” Haywood said.

“It will promote Diaspora investments in the economic and business development of SVG and in the United States,” he added.

“We believe that it will

provide the opportunities for all Vincentians to discuss the business and economic development issues in SVG and in the SVG-U.S. Diaspora,” he continued.

Additionally, Haywood said such initiative will promote “productive employment and wealth-creation in SVG and in the United States, via Diaspora investments.

“This initiative will help us to think through these matters and to develop clear views as to how the Diaspora could create a platform for promoting business activities that will benefit Vincentian businesses and, by extension, all Vincentians at home and abroad,” he said.

Toney was the featured speaker at the meeting, which also heard from Edwards, representing COSAGO; Cecil McKie, SVG Minister of Sports, Tourism and Culture; U.N. Amb. Rhonda King; Consul Gen. Selmon Walters; Mulrairie “Mac” Richards, public relations officer of the St. Vincent and the Grenadines Diaspora Committee of New York, Inc.; Ben Harrison, Toronto-based International Correspondent, THE VINCEN-TIAN newspaper; and Margarita Cabral, of the Brooklyn-based New American Chamber of Commerce.

## SMALL BUSINESS RESOURCES

### Small Business Energy | SmallBusinessEnergy.com

[www.smallbusinessenergy.com/NewYork](http://www.smallbusinessenergy.com/NewYork)  
Save on Small Business Energy Bills and Compare Rates. Get a Quote Now!

### NYC Small Business Resource Center | The New York Public Library

[smallbiz.nypl.org](http://smallbiz.nypl.org)

### Small Business Services - Empire State Development New York

[www.esd.ny.gov/smallbusiness.html](http://www.esd.ny.gov/smallbusiness.html)

### Small Business - Business First - New York State

[www.nyfirst.ny.gov/ResourceCenter/SmallBizMenu.html](http://www.nyfirst.ny.gov/ResourceCenter/SmallBizMenu.html)

### 2013 New York, NY Small Business Resource

[www.sba.gov/sites/default/files/files/resourceguide\\_3135.pdf](http://www.sba.gov/sites/default/files/files/resourceguide_3135.pdf)

### Business Resources: Internet Bibliographies: New York State Library

[www.nysl.nysed.gov/reference/busref.htm](http://www.nysl.nysed.gov/reference/busref.htm)  
Selected business-related web sites compiled by staff at the New York State Library for use in response to reference questions.

### Start a Business in New York - Resources for New York Small Businesses

[manhattan.about.com/od/careersjobs/a/nysmallbusiness.htm](http://manhattan.about.com/od/careersjobs/a/nysmallbusiness.htm)  
Find resources and advice on starting a

business in New York City. Get information on New York business licenses and incorporation, free NYC resources for starting a business.

### Your Money New York - Help and Resources for Small Businesses

[www.yourmoneyny.com/helpresource/smallbusiness/index.php](http://www.yourmoneyny.com/helpresource/smallbusiness/index.php)  
This section of Your Money New York is designed to help small business owners – and New Yorkers interested in starting a small business.

### Small Business Resources - The Business Council of New York

[www.bcny.org/inside/smallbusiness.htm](http://www.bcny.org/inside/smallbusiness.htm)  
Capital Business Blog - Read about the issues. Visit [www.nyfirst.ny.gov](http://www.nyfirst.ny.gov) to learn what New York State can do for businesses.

### Resources for Businesses in New York City - bfindapc.com

[www.bfindapc.com/...business-resource.../resources-for-businesses-i](http://www.bfindapc.com/...business-resource.../resources-for-businesses-i)  
If you operate a business in New York City, you are especially fortunate. The city has pulled together a wealth of resources for small business owners.

### Small Business Resource Guide - New York - HUD

[www.hud.gov/offices/osdbu/resource/guide/local/newyork.cfm](http://www.hud.gov/offices/osdbu/resource/guide/local/newyork.cfm)  
100+ items – to assist the small business community in the State of New York.

### Empire State Development Strategic Business Division Minority and Women's Business Development

New York Regional Office 26 Federal Plaza, Suite 3108. New York, NY 10278

# Erectile Dysfunction — more than a quality of life problem!

BY JACK RYAN

The benefits of seeking professional treatment for erectile dysfunction may seem obvious to both the patient and his partner. But what many men don't realize is that a thorough evaluation of this condition can uncover serious threats to their health.

Dr. Vitaly Raykhman, Director of the New York Urological Institute in Sheepshead Bay, says that millions of men in the United States suffer from erectile dysfunction. Typically, he said, the man can't perform at all or is not satisfied with his sexual performance. The dysfunction can surface at any age, but it is more common in men 50 years old or older.

The problem can be psychological or the impotence may be caused by physiological abnormalities. In such cases, he said, the dysfunction may be

related to diabetes or an indication of even more serious conditions. A series of clinical tests done at the Urologic Institute can help doctors determine the reason of impotence.

"Sexual dysfunction is not just an embarrassment or inconvenience," said Dr. Raykhman. "It is important that men who are experiencing this problem be promptly and properly evaluated by a urologist."

Erectile dysfunction, he stressed, can be an early indicator of "metabolic syndrome," a name given to a group of factors that raise the risk for heart disease and other health threats, including heart attack and stroke.

"The fact that they are bringing this problem into their consciousness can give a physician several years of lead time in heading off these far more serious medical problems,"

said Dr. Raykhman. "Could a visit to a urologist indirectly save a patient's life? Absolutely."

At this time, the doctor explained, there is no cure for organic impotence. However, a skilled urologist can slow the progress of the dysfunction and with the proper treatment most patients can regain a more satisfying sexual experience.

Although surgery is sometimes necessary, "it's the last resort." Changes in lifestyle can often reverse the effects of erectile dysfunction. These include exercise, improvements in diet, and a reduction in smoking and alcohol intake. Erectile dysfunction can often be treated with medications such as Cialis, Viagra, Levitra or hormone therapy.

Dr. Raykhman stressed that because an erection is a vascular event, erec-



New York Urologic Institute is in a modern facility with state-of-the-art equipment that allows for testing to be done at one convenient location.

tile dysfunction needs to be taken seriously. Fortunately, he said, for many reasons, men are no longer as reluctant to discuss this condition with a doctor as they once were.

The New York Urologic Institute is equipped to give

patients a thorough evaluation and offers a wide range of treatment options.

*New York Urologic Institute [2632 E. 14th St. between Avenue Z and Shore Parkway in Sheepshead Bay, (718) 878-3523, [www.AccordMd.com](http://www.AccordMd.com). Open*

*Monday through Friday, 9 am-6 pm. Saturday and Sunday 9 am-3 pm.*

*[107-15 Jamaica Ave. between 107th and 108th streets in Richmond Hill, Queens, (718) 878-3523]. Open Monday through Thursday, 9 am-5 pm.*

ATTORNEY

SE HABLA ESPAÑOL

## ACCIDENT VICTIMS

**AUTO ACCIDENTS • TRIPS AND FALLS • CONSTRUCTION INJURIES**

**FREE CONSULTATION • No Fee Unless Successful\***

### Our Lawyers Will Come To You!

Home, Office or Hospital Visits Available At No Charge

**WILLS & REAL ESTATE • PERSONAL INJURY**

Auto Accidents • Truck Accidents • Bus, Train, & Subway Accidents • No-Fault Cases  
Spine & Neck Injuries • Slip & Fall • Pedestrian • Defective Products • Lead Poisoning  
Schools & Playgrounds • Dog Bites



Construction Accidents • Stairways • Ladders  
Scaffolds • Elevator/Escalator Injuries • Burns  
Improper Security • Machine Accidents • Workers' Comp

**MEDICAL MALPRACTICE/NURSING HOME INJURIES**

Wrongful Death • Misdiagnosis • Birth Related • Cerebral Palsy

# ARZE & MOLLICA, LLP

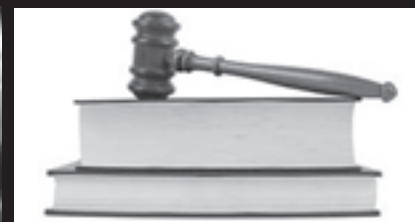

Brooklyn: 2352 80th Street, Brooklyn, NY 11214

**T:718-996-5600**

Manhattan: 39 Broadway, Suite 950, NY, NY 10006

**T:646-459-7548**

\*Past Results Do Not Guarantee Future Outcomes

# Education system

**Continued from Page 8**  
support and engage immigrant parents in the United States, while ongoing budget battles in Washington are impacting on initiatives that have partially filled this gap.

The government has cut funds for Head Start, a federal programme that provides public preschool and health services to low-income children. And Even Start, a federal family literacy programme that integrated adult literacy with parenting education, was defunded in 2010.

These cuts disproportionately affect immigrant families.

Some programmes do exist, either through private or piecemeal funding, but these advocates say these typically lack accountability standards and continuity, since funding is so fickle. Such initiatives also tend not to communicate or coordinate with one another, meaning, for instance, that programmes aimed at secondary education do not

build on those for primary schooling.

Focus group participants from MPI's study said that programmes offered very limited translation and interpretation services, and generally ignored languages other than Spanish. Some projects did offer classes to parents, but long waiting lists, inconvenient hours or lack of child care reportedly deterred parents – despite a strong desire to participate.

"I don't go to [parent engagement] programmes like this because one time I went, and the school had me waiting for an hour, standing around and waiting for an interpreter," one parent told MPI researchers. "I was so tired of waiting – I have no idea what they told me in the end and they didn't help me at all."

Even when translation services are provided or parents speak English, understanding teachers or school materials requires a substantial understanding of the U.S. education lexicon and culture.



One federal project, Promise Neighborhoods, is funding a pilot programme specifically geared towards immigrant parents in a neighbourhood near Washington.

"In the majority of the families we work with, the parents are trying to be deeply engaged in their children's lives," Eliza Leighton, the programme's director, told IPS.

"Many parents came to this country to make sure their kids have access to quality education, yet when they arrive they find there's very

limited information available for them."

The lack of information leaves parents unaware of available resources and also leaves them in the dark about early childhood development.

"For example, many parents work under the misconception that they should only read to their child in English – and if it's not in English, then they shouldn't read at all," Leighton says. "That's not true. It's wonderful to read to your child, even if it's not in English."

The pilot project has four

main components. First are "parent promoters", each of whom has about 50 families to connect to the community. Second is a 13-week parent and teacher class, conducted mostly in Spanish, to teach parents how to support their child's development.

The third component is a series of community events to build a support community for immigrant parents. Finally, the last part is a class to educate teachers on the linguistic and cultural needs of their students and

families.

If the programme is successful, supporters say it could be expanded throughout the country.

## DATA NEEDED

MPI notes that increasing the collection of pertinent data would increase the visibility of immigrant parents for school administrators, especially parents who speak a language other than Spanish.

Currently, from the school to federal level, data collection begins in kindergarten. But more information could help teachers better understand the needs of their students and help policymakers hear demands for programming catered to immigrant parents.

Of course, programmes to educate immigrant parents overlap with the field of adult education, like adult literacy classes. However, few federal adult-education programmes meet the needs of parents that lack English-language proficiency.

"Right now, adult education programmes are only meeting about four percent of needs," McHugh said.

**NEED IMMEDIATE CASH?**

Bring Your Gold, Diamonds, Jewelry, Watches & Silver For **CASH LOANS**

Highest Prices Given  
Lowest Rates Guaranteed!!!

**WE BUY**

- GOLD
- DIAMONDS
- JEWELRY
- WATCHES
- SILVER

All Transactions Are Private & Confidential In A Safe Area

**DON'T SELL UNTIL YOU SEE US FIRST  
WE GUARANTEE THE HIGHEST PRICES!!!**

**A-1 PAWN BROKERS**  
SERVING THE PUBLIC SINCE 1992

**THE PLACE THAT TREATS YOU LIKE FAMILY**

2131 CONEY ISLAND AVE. • 718-627-2622  
MON.- THU. 9AM - 7PM • FRI. 9AM - 5PM • SUN. 11AM-5PM • SAT. CLOSED  
Licensed by NYC • Official Center, Licensed by the City of NY • Lic.#1108177  
We Speak English, Hebrew, Portuguese, Russian, Spanish and Turkish

**MR. VACUUM**

**SALES • PARTS • REPAIRS**

**KIRBY dyson SINGER Miele Electrolux**

**Guaranteed Lowest Prices in Brooklyn!**  
**On ALL Air Conditioners & Major Appliances**

**MR. VACUUM COUPON**

**FREE PICK-UP & DELIVERY**

**REPAIR ANY VACUUM OR SEWING MACHINE**

**\$1495** + PARTS + TAX

WITH COUPON ONLY. EXPIRES 07/31/14

**APPROVED SINGER & Miele DEALER**

**8705 5<sup>TH</sup> AVE. • MRVACUUMSTORES.COM**  
**718-748-5288 • 1-800-61-FIXED**

**We Will Beat & Match Any Price On Air Conditioners**

**AMANA • GE FRIEDRICHS FRIGIDAIRE & MORE**

**CARIBBEAN AMERICAN  
HEALTHCARE**

**AWARDS**

*Gala*

**JUNE 25, 2014**

**5pm - 9:30pm**

**718-629-3500**

**TROPICAL PARADISE BALLROOM**

**VALET PARKING**

**1367 Utica Avenue, Brooklyn, NY 11203**

*Bet. Farragut and Foster Avenue*



**CARIBBEAN HEALTHCARE AWARDS  
HONOREES**

Sandra Aberdeen  
 Veronica Alert, RN  
 Debra Ambrose, RN  
 Janet Marva Bowen, RN  
 Tenisha Brown  
 Ruby Bryan, RN  
 Dr. Karlene ChinQuee  
 Dr. Millicent Comrie  
 Joan Rosalee Davis, RN  
 Winsome Mclean-Davis,  
 LNHA, LMSW  
 Jacqueline Gilbert, RN  
 Verona Greenland  
 Dr. Christina Guillen  
 Yvette Halstead  
 Mohanie Hemraj  
 Jennifer A. Henry, RN  
 Dr. Juliet Hudson  
 Vincent E Hutchinson, MD  
 Marisol Italia Perez  
 J. Keith Joseph, MD  
 Dr. Tracey Joseph, DDS  
 Dr. Danielle Laraque  
 Dr. Roy London  
 Magalie Marcelin

Alison L. McKenzie, RN  
 Dr. Ronald H. McLean,  
 BDS, MD, FACS  
 Guilaine Michaud, BSN, RN  
 Tina M. Morris, LCSW  
 Jennifer Morris  
 Dr. Patricia Nicholas  
 Beverly Nichols  
 Dr. O'Neill Parris  
 Claudette Powell, RN, MA  
 Professor Denese Ramadar  
 Lorna Rawle  
 Dr. Ella Jean Richards  
 Lorna Samuels, RN, MSN  
 Dorian P. Samuels  
 Dr. Bernadette Sheridan  
 Avril P. Silcott, RN  
 Opal Sinclair-Chung  
 Carol St Pierre  
 Dr. Roy Streete  
 Dr. Emmanuel Valery  
 Merle Fearon Warren  
 Paulette P. Williams,  
 RNC, BSN, MSN  
 Angella Williams

Congratulate the honorees  
 with your messages in the **June 20<sup>th</sup>**  
**Caribbean Life**  
**SPECIAL EDITION**

Deadline Monday, June 16<sup>th</sup>



Call Jennifer Stern with any question  
**718-260-8302**  
 or email [jstern@cnglocal.com](mailto:jstern@cnglocal.com)

Join us as we celebrate Caribbean American's essential contributions to healthcare in New York City

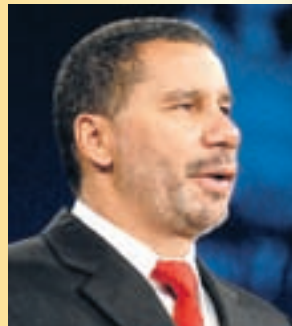

**Keynote Speaker**  
**The Honorable**  
**David A. Paterson**  
 Former Governor of New York  
 Chair of NY State Democratic Party

The evening will start with wine, beer,  
 cold beverages and networking  
 from 5pm to 6pm

Doors open at 5:30pm for the buffet dinner  
 Our awards and presentations begin at 7:15pm

**All seat prices are \$85.00**

# MEDICAL RESEARCH GUIDE

## A better route to managing overactive bladder

Should have fewer bathroom stops

If the signs of overactive bladder (OAB) are becoming an all too familiar pattern, it may be time for a new direction. The SYNERGY study is a research study examining an investigational combination of two drugs prescribed for OAB to see if, when taken together, they provide more relief than when taken on their own. If you experience the frequent and sudden urge to urinate, followed by leakage, you may be eligible to participate.

TO learn more, visit [OABandYou.com](http://OABandYou.com), or speak with our staff by contacting 917-409-3917 or [beverly@manhattanmedicalresearch.com](mailto:beverly@manhattanmedicalresearch.com)



## Advertise your Clinical Studies in New York's largest group of community newspapers.

- Weekly bannered directory
- Ads will also appear in Classifieds & Online

**ASK HOW YOU CAN GET EDITORIAL COVERAGE OF YOUR STUDY**

**Call Brian Rice  
718-260-4537**



Temporah Williams, left, and Rutland Center Director Nicole Casimir  
Rutland Adult Day Health Center

## Milestone celebration for Brooklyn centenarian

By Chudi Chukwudi

The Rutland Nursing Home's Adult Day-Care Center at Brooklyn's Kingsbrook Medical Center held a 100th birthday party for Mrs. Temporah Jones Williams last week.

Center staff, friends and medical specialists showed up to honor Ms. Williams on her incredible day that included a DJ, refreshments, dancing and a number of festivities. Dressed in a lovely purple two-piece outfit, Ms. Williams was radiant as she was surrounded by the many caregivers who love and adore her.

The Rutland Center, which caters to a cultural cross-section of the community, enables physically challenged adults and frail elderly to spend the day with friends at the facility and their evenings at home. Caregivers find the Center a tremendous asset in providing respite for the elderly as they tend to their busy schedules. Seniors are eligible for the program if they do not require a full-time nursing home but are in need of supportive health-care to help them maintain independent lifestyles in the

community.

Mrs. Temporah Jones Williams, also known as "Tempie" was born at home at the family farm in Millen (Jenkins County) Georgia on

**"I opened this place and I'm still here. This is my spot!"**

June 4th, 1914. Her father was a farmer whose crop included cotton, corn and vegetables and her mother cooked for the Jones family until their death. She was one of seven sisters and two brothers and still maintains contact with "her aunt's daughter" a first cousin who still resides in Georgia. She attended grade school in Millen until she moved in with her grandmother and aunt to accommodate her high school education in Atlanta, Georgia about 193 miles away.

She moved back home after high school and became a schoolteacher for Grades 1-6 and also worked on the family farm as a cotton picker.

Mrs. Williams married at

age 28 to James Marshall Williams who she said was "five years older than her". They moved to Savannah, Georgia, his home town, and gave birth to their son, John Elbert in 1943. She moved to Brooklyn about 60 years ago and currently resides in Crown Heights.

Mrs. Williams joined the Kingsbrook Jewish Medical Center-Rutland Adult Day Care Center upon its establishment in 1990 at age 76 and has been an active participant since then.

With pride she stated: "I opened this place and I'm still here" and, pointing to her seat, adds: "This is my spot!"

She remains active at Brown Memorial Baptist Church and was an avid bowler up until recently with numerous awards for her feats. She loves vanilla ice cream, her favorite color is purple, and can still dance a storm. Her favorite hymn is "I come to the garden alone."

She is known as a very optimistic, generous individual, and is a "ball of fire", energetic and dynamic, celebrating her 100th birthday.

# Long Island



# CARIBBEAN AMERICAN HERITAGE FESTIVAL 2014

## WOULD LIKE TO THANK ALL THE SPONSORS

FINE ISLAND FOOD, GOOD VIBES & SPIRIT



**KARAOKE WEDNESDAYS**  
**LADIES NIGHT THURSDAYS**  
**LIVE BAND FRIDAYS**  
**CLUB NIGHT SATURDAYS**  
**OLDIES SUNDAYS**

OPENING HOUR  
 Mon-Fri (4pm-4am)  
 Sat - Sun (2pm - 4am)

784 Elmont Road, Elmont, New York 11003  
 (516) 285-0635

1800.774.2803

**Unique Biz & Events Solutions, Inc**  
 entrepreneurs, restaurants, clubs, lounge, charity, promoters,

CALL US...For all your  
*Administrative, Event Planning and Entertainment Needs*

**FREE CONSULTATION.....1.800.774.2803**



**CELEBZ STYLZ**  
 Hair Salon  
 THE #1 LONG ISLAND CITY HAIR SALON FOR THE QUEEN - GET FLOORED TONIGHT!

**Tommy**  
 Lactician • Stylist

347.654.6349  
 spiceboy0000@gmail.com  
 @boyimpression

**METROPOLITAN WHITE**  
*Vodka*

CONTACT: 516.225.9127

**MS**  
**Freeport Medical Supply Inc.**  
 Xtra Care Pharmacy  
 One Stop Shopping For All Your Medical Needs

75 South Main Street, Freeport, NY 11520  
 516.208.7432

13889 Francis Lewis Blvd, Rosedale, New York 11422  
 Mon - Wed: 11:00 am - 10:30 pm  
 Thu - Fri: 11:00 am - 12:00 am  
 Sat: 8:30 am - 12:00 am  
 Sun: 8:30 am - 10:30 pm



Phone (718) 527-7355  
 Email henricasrestaurant816@gmail.com  
 Website http://henricas.net

**KARAOKE WEDNESDAYS**  
**LADIES NIGHT THURSDAYS**  
**LIVE BAND FRIDAYS**  
**CLUB NIGHT SATURDAYS**  
**OLDIES SUNDAYS**



**ORGANO GOLD**  
 INDEPENDENT DISTRIBUTOR  
 NARDIA ALDRIDGE  
 917.280.5359



*Mystical*  
**SPEED**  
 FINALIST  
 BOOK AWARDS  
 HUBERT GUSCOTT

**Digicel**

**ORGANO**  
 Nardia & Roger Aldridge  
 917-280-5359  
 718-598-0099  
*Change Your Coffee. Change Your Life!*  
 nardiaroger@aol.com  
 nraldridge.myorganogold.com



**CaribZone**



**Island Melody**  
 Jamaican  
 Black Fruit Cake Mix  
 NET WT 14 OZ (398g)

**Fusion.**  
 Consult. Combine. Create

**Caribbean Life**

3007 Farragut Rd, Brooklyn, NY 11210 (corner of Nostrand ave)

# Be Well

## Primary Health Care Center, LLC

718-253-WELL (9355) 718-434-0711  
Diagnostic and Treatment Center  
NYS Article 28 Facility

**MEDICAID, MEDICARE**  
MEDICAID HMOs & Most Major  
Insurance Plans Accepted



LAB TESTS  
SONOGRAMS  
EKG'S

NO INSURANCE?  
STOP BY TO FIND OUT  
HOW YOU CAN GET  
INSURED TODAY!

We Speak Creole, Russian, Philippine & Spanish

### ORTHOPEDIC SURGEON

Arthroscopic Surgery • Joint Replacement • Sports Medicine • Hand Surgery  
• Consultation & Other Services

### PAIN MANAGEMENT

Services will include pain management, electromyography, interventional pain procedures including, but not limited to joint injections, epidural steroid injections and nerve blocks, also electromyographic studies for patients with nerve and muscle disease, neck pain, back pain, numbness and tingling in the arms, chronic headaches, joint injuries such as knee and shoulder pain.

### DENTISTRY

General Dentistry for Children and Adults • Dentures, Fillings, Root Canals, Crowns & Bridges, Extractions, Bleachings, Cleanings, Check Ups, Gum Treatment

### UROLOGY

For Men, Women and Children. We treat the following common urological conditions: prostate cancer, kidney cancer, testicular cancer, urinary incontinence, kidney stones, urinary tract infections, impotence/erectile dysfunction

### CARDIOLOGIST

### PHYSICAL THERAPY

Evaluation and Treatment of Acute and Chronic Disorders Including Strokes, Fractures, Tumors, Arthritis • Pain Management Massage, Ultrasound, Electrical Stimulation, Therapeutic Exercises

### GASTROENTEROLOGY

### ENDOCRINOLOGIST

Diabetes • Thyroid Dysfunction • Weight Control • Metabolism Abnormalities • Osteoporosis

### GENERAL VASCULAR SURGEON

Diagnosis & Treatment of Diseases and Tumors of the Skin, Soft Tissue, Breast, Stomach, Pancreas, Bile ducts, Gallbladder, etc. Diagnoses and Treatment of disease of Veins & Arteries  
• Breast Biopsy, etc. • Laser Surgery, Vascular Surgery, Laparoscopic Surgery

### OB/GYN

- Prenatal Care and Delivery • Pap Smears
- Pregnancy Testing • Family Planning
- High Risk Pregnancies Management
- Uterine Fibroids and Chronic Pelvic Pain
- Menopausal & Menstrual Disorders, Infertility
- Pelvic Relaxation & Urinary Incontinence
- HIV & STD Testing and Treatment

### NEUROLOGY

- Comprehensive Neurology Exams for Adults
- Alzheimer's and Parkinson's Diseases
- Headaches, Seizures, Chronic Pain, Stroke
- Carpal Tunnel Syndrome • Rehab
- Muscle Testing • Neurological Testing

### PODIATRY

- All Foot & Ankle Related Problems
- Blisters and Calluses
- Foot Odor, Ingrown Toenails, Warts, etc.
- Numerous Treatments & Services for DIABETIC PATIENTS

### DERMATOLOGY

Full Spectrum Skincare for Adults and Children

- Rash • Acne • Warts
- Brown Spots • Sun Damage, etc.

### INTERNIST

- Medical History & Physical Exams
- Wound Care • Cholesterol Screening
- Blood Pressure • Flu Vaccines
- Diabetes, Arthritis, Infections
- Hypertension, Heart Diseases
- Blood, Urine & Stool Testing

### PEDIATRICIAN

- Comprehensive Exams of Children of All Ages
- Osteopathic Manipulations for Treatment of Asthma, Headaches, Sinusitis, Otitis, etc.
- Sick And Well Visits • Immunizations
- All Necessary Forms for Schools, Colleges, Camps & WIC Programs

### OPHTHALMOLOGY

- Comprehensive Eye Exams for Adults & Children
- Nearsightedness, Farsightedness,
- Astigmatism, Glasses Prescribed
- Evaluation & Treatment of Eye Diseases
- Glaucoma, Cataracts, Diabetic Retinal Evaluation, Dry Eye

# Grenada Revolution film at Medgar Evers

“Forward Ever: The Killing of a Revolution,” a documentary film that examines the rise and implosion of the Maurice Bishop-led People’s Revolutionary Government (1979-1983) of Grenada will have its New York premiere on Friday, June 20 at the Main Auditorium, Medgar Evers College, CUNY, commencing at 6:00 p.m. The film, which runs approximately two hours, focuses on events in 1983 surrounding the execution of Prime Minister Bishop, cabinet members and civilians and the subsequent U.S. military invasion in alliance with certain governments in the region.

The film was produced and directed by the noted documentary filmmaker Dr. Bruce Paddington. This special screening is being presented by the Caribbean Awareness Committee in conjunction with the Medgar Evers College Film & Culture Series

and the film’s producer.

“Forward Ever: The Killing of a Revolution” utilizes archival footage, some of it never before publicly shown, and interviews with a number of key participants to raise some profound questions about this tragic and pivotal turn of events in Caribbean history – a sequence that began in 1979 with the dramatic wresting of power from Grenada’s then prime minister Eric Gairy by Bishop’s New Jewel Movement.

Roger Toussaint, former president of the Transport Workers Union Local 100 and a member of the Caribbean Awareness Committee, said: “The Grenada experience impacted the course of struggles throughout the Caribbean and beyond. This film makes a valuable contribution to those of us concerned about the way forward to a progressive Caribbean.”

The film’s New York pre-

miere at Medgar Evers was deliberate scheduling, in light of and intended for the large Caribbean immigrant population domiciled in the borough. Other screenings of the film are scheduled for Harlem (June 21), Lower Manhattan (June 26) and Rochester, NY (June 27).

The Medgar Evers screening will be followed by a Q & A session with a panel comprising Dr. Paddington, Grenadian academic Dr. Paul Clement and Toussaint as moderator. Admission to this screening is free and open to the general public. The Medgar Evers College auditorium is located in the main campus building, 1650 Bedford Ave., Brooklyn, at Crown Street.

For further information, contact Caribbean Awareness Committee at: 718-532-6347. The film’s trailer may be accessed at: <http://www.youtube.com/watch?v=DzDAIZFESkQ>.

## NURSING HOME ABUSE LAWYERS

*If you have a loved one in a nursing home or assisted living facility who has suffered from:*

- Infected bedsores or pressure ulcers
- Substantial weight loss or gain
- Unexplained injuries such as broken bones
- Malnutrition and dehydration
- Medication errors or overdoses
- Emotional agitation or anxiety
- Unexpected or unexplained death

**Call us for a free consultation: 212-608-8840**

**Bamundo Zwal & Schermerhorn, LLP**

*No Recovery - No Fee*

The Best of **Caribbean Life**.....  
is just a click away.

Go to [www.CaribbeanLifeNews.com](http://www.CaribbeanLifeNews.com) for the latest in Caribbean news, entertainment, sports, business, viewpoints and more

**Caribbean Life**

**Updated every weekday!**

North America’s Largest Caribbean Newspaper

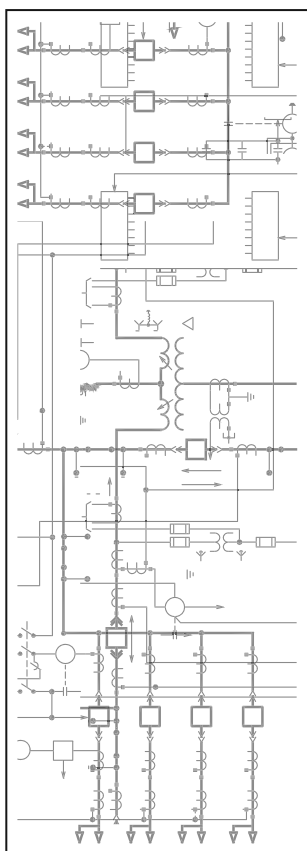

**SOME APPS ARE GREAT FOR KILLING TIME.  
THIS ONE’S GREAT FOR SAVING IT.**



To help make your life easier, we’ve created the My conEdison app for Android™ and iPhone®. Use it to pay your bill, view your billing and payment history, submit a meter reading, and more. It also lets you access our interactive outage map, showing you which areas are affected and providing estimated restoration times. Simply put, it’s an app that’s worth its weight in kilowatts. And you can download it for free at Apple’s App Store™ and the Google Play™ Store. For more information, go to [conEd.com/App](http://conEd.com/App), or visit us on Facebook or Twitter.



**conEdison**

**EVERYTHING  
MATTERS**

# Family Dental Care

"TOP QUALITY CARE AT AFFORDABLE PRICES"

over 10 years  
in business

**Dr. Irina Yesina DDS**  
Welcomes Children and Adults



**TOOTH WHITENING**  
**FILLINGS (WHITE)**  
**CROWNS**  
**BRIDGES**  
**ROOT CANALS**  
**DENTURES**  
**EXTRACTIONS**  
**CLEANINGS AND MUCH MORE...**

**CURRENT SPECIALS**  
**Flexible Partial Dentures**



**OTHER SPECIALS AVAILABLE**

711 Nostrand Ave  
(Bet. Park Pl & Sterling Pl)  
Brooklyn, NY 11216

CALL FOR APPOINTMENT  
**718.778.7600**

Medicaid, Locals and Most Insurances Accepted!!!

# The measure of a man

Continued from Page 3 amidst the storm." There was "a softer genius behind "his outward countenance. He was "never faunted by power." "I'm reminded of Maya Angelou's poem: "When great trees fall." "We all can be and are better because he existed."

**Eric Schneiderman:** "He was incredibly generous with his time."

**Charles Rangel:** "I'm pleased that Basil came into my life." "I didn't know that he was part of the 'Bulay,'" "What we can do to be more like Basil is to fight for teachers, fight for children, for people who are sick" ... "I shared a part of the wonderful friendship of Basil Patterson."

**David Dinkins:** [Sobbing]: "The Gang of Four is no more." I cannot remember anything that has hit me as hard as losing Basil. His "unparalleled dedication to helping to serve the people of this city." "We all have the power to live our lives with ... and that's what Basil did." "Death is not the end, but the opening of a door that leads to eternal life. We must not lose sight of where he came from and where he's going. Serving others is the rent we pay for living here on earth." "Basil has paid in full."

**Keith Wright:** "He was a friend to his enemies. Never once did Baail

get agitated by anyone. His legacy is with his grandchildren."

**Inez E. Dickens** "Today the Village of Harlem is celebrating the memory of its son." "I knew Basil since age 9." "I was blessed to know this man of distinction." "He broke down barriers and gave hope to Black people in this country." "He was a soft-spoken... but strong labor leader. A fierce litigator..." "No man succeeds without a good woman." "The next gang of four would come from the Patterson family. "People may fight what you said ... what you did, but they won't forget how you make them feel." "He was "a friend of age and a guide of youth."



JAMAICA



BAHAMAS



ANTIGUA



DOMINICAN REPUBLIC



GRENADE



GUYANA



BARBADOS



BELIZE



HAITI



DOMINICA



PANAMA



TRINIDAD & TOBAGO



ST. LUCIA



NICARAGUA



BERMUDA



PUERTO RICO



ST. VINCENT



US VIRGIN ISLANDS



CAYMAN ISLANDS



HAITI



ST. KITTS



ST. MARTIN

## GUYANA

**SPRING SPECIAL**  
**JUMBO BARREL**

**\$69.00**

includes pick up in  
Brooklyn, Bronx and  
Queens  
(expires 06/30/14)

## TRINIDAD • POS

**SPRING SPECIAL**  
**JUMBO BARREL**

**\$59.00**

includes pick up in  
Brooklyn, Bronx and  
Queens  
(expires 06/31/14)

## JAMAICA

- **Kingston-** Agent Freight Handlers office in New Port West and private warehouse Adolph Levi
- **Quik turnaround...** most times you in and out under 2 hours.
- **Montego Bay-** Agent Freight Handlers and private warehouse with Seaboard Marine with quicker

turnaround time than the port.  
• **Door to door service** at very competitive rates. Safe and fast deliveries  
• **Local charges comparable** or lower than most agents in Jamaica. (Don't be fooled by a little lower price in USA but much higher local handling fees in Jamaica).

**WE SHIP TO EVERY CARIBBEAN DESTINATION**

# ECONOCARIBE

Your Shipping Solution to the Caribbean and more

**SUMMER SPECIALS**



**We ship:**  
• Boxes • Crates • Appliances • Furniture  
• Household items • Equipment • Machinery & more.  
**Book your full containers at reasonable rates.**

**Empty barrel & boxes available.**



147-46 176 St. • Jamaica, Queens NY • (Back of DMV off Rockaway Blvd.) **718-244-7447**



# All Cargo Service to and from the Caribbean Mexico, Central & South America



- Air Cargo
- Small Package (up to 60lbs)
- Large Boxes & Barrels
- Personal & Commercial Shipments
- Insurance Available
- Online Tracking
- Safe & Secure Shipping



Jamaica, NY  
**718-656-8356**

Email: [sales.jfk@amerijet.com](mailto:sales.jfk@amerijet.com)

Brooklyn, NY  
**718-629-0484**

Email: [sales.nyb@amerijet.com](mailto:sales.nyb@amerijet.com)

Bronx, NY  
**347-905-5168**

Email: [sales.lga@amerijet.com](mailto:sales.lga@amerijet.com)

Newark, NJ  
**862-772-7992**

Email: [sales.ewr@amerijet.com](mailto:sales.ewr@amerijet.com)

Offer applies only to general air freight charges above 60 pounds or 27 kilos. All freight charges are based on actual or dimensional weight, whichever is greater. Offer is not available for Hazardous Materials, Live Animals or High Value Items. Service/shipping charges cannot be combined with any other discount or promotional offer. Accessorial charges and local termination fees apply. Additional services are subject to AmeriJet's memo tariff and to applicable accessorial or service charges.

[www.amerijet.com](http://www.amerijet.com)

code: PRGEN1-JFK03032014-A



Go to [www.Caribbeanlifeneews.com](http://www.Caribbeanlifeneews.com) for the latest in Caribbean news, entertainment, sports, business, viewpoints and more.

DEVELOP YOUR  
WORK SKILLS.  
INTERVIEW WITH  
CONFIDENCE.  
**GET THE JOB  
YOU WANT.**

Click here to learn about the opportunities at  
the Workforce1 Healthcare Career Center



#### FULL-DAY UPK LOCATIONS

##### Bronx

1778 Southern Blvd.  
Bronx 10460  
718-589-5900

1465 Webster Ave.  
Bronx 10456  
718-681-3040

1336 Louis Nine Blvd.  
Bronx 10459  
718-991-2119

2901 White Plains Rd.  
Bronx 10467  
718-653-3714

3942 White Plains Rd.  
Bronx, NY 10466  
718-653-4043

770 St. Ann's Ave.  
Bronx, NY 10455  
718-585-1472

##### Brooklyn

58 Belmont Ave.  
Brooklyn 11212  
718-346-1064

1491 Broadway Ave.  
Brooklyn 11221  
718-455-1612



Child Care + Education =  
A Child's Bright Future



Brightside Academy offers:

# Full-day UPK

- Kindergarten readiness program
- Nutritious daily meals and snacks
- Passionate and caring teachers

Reserve Your Child's Space:

# 844-KIDS-555

or visit [BrightsideAcademy.com/CL](http://BrightsideAcademy.com/CL)

EQUAL OPPORTUNITY CARE PROVIDER

Stay Connected!

1% IS ALL YOU PAY TO DRIVE AWAY! WE ARE SURE TO HAVE A CAR TO FIT YOUR BUDGET!

EASY FINANCING! OVER 30 BANKS ON LOCATION! EASY FINANCING! NO CREDIT! NO PROBLEMS!

Whether you're buying or selling a car, If You Can't Make It To Us, We'll Pick You Up. Call 877-356-5030 For Complimentary Pick Up

# FIND A WHOLE LOT OF SAVINGS & SELECTION AT MAJOR WORLD!

PURCHASE A VEHICLE BETWEEN 9AM-5PM FROM NOW UNTIL MONDAY AND RECEIVE A GIFT ON US OF EITHER AN IPOD, NAVIGATION, CAR ENTERTAINMENT SYSTEM or BLUETOOTH KIT... COMPLIMENTS OF MAJOR WORLD!^^

## CARS STARTING AS LOW AS \$2,995!

YEAR	MAKE/MODEL/MILES	STK /VIN	PRICE	YEAR	MAKE/MODEL/MILES	STK /VIN	PRICE	YEAR	MAKE/MODEL/MILES	STK /VIN	PRICE
2001	Honda Civic, 87k	73406	\$2,995	2005	Jeep Gr. Cherokee, 100k	654760	\$6,995	2008	Toyota Camry, 65k	6035	\$8,995
2000	Honda Civic, 130k	544413	\$2,995	2008	Saturn Vue, 116k	686457	\$7,995	2007	Acura TSX, 92k	020711	\$8,995
2003	Honda Accord, 91k	72885	\$3,995	2009	Honda Accord EX, 40k	65124	\$7,995	2005	Honda Pilot, 116k	532858	\$9,995
2008	Hyundai Accent, 16k	1087201	\$5,995	2012	Hyundai Elantra, 15k	79461	\$8,995	2006	BMW X5, 71k	Y30956	\$11,995
2005	Chevy Avalanche, 174k	101282	\$5,995	2007	Nissan Pathfinder, 130k	624816	\$8,995	2006	Infiniti M-35x	252731	\$13,995
2006	Toyota Rav4, 145k	5347	\$5,995	2006	Toyota Sienna, 82k	517555	\$8,995	MANY MORE LIKE THIS TO CHOOSE FROM!			

## MANAGER SPECIALS

YEAR	MAKE/MODEL/MILES	STOCK /VIN	PRICE	YEAR	MAKE/MODEL/MILES	STOCK /VIN	PRICE
2010	Toyota Camry, 34k	1013	\$8,995	2008	BMW 535xi, 44k	4519	\$13,995
2008	Hummer H3, 97k	3802	\$9,500	2011	Ford Edge, 51k	82896	\$16,995
2011	Ford Escape XLT, 25k	74493	\$9,995	2012	Nissan Maxima, 20k	3788	\$18,995
2012	Volkswagen Passat, 22k	4362	\$13,995	2010	Infiniti G37, 28k	70898	\$18,995
2011	Nissan Rogue, 50k	69968	\$13,995	2008	Mercedes CLS 550, 57k	82172	\$22,995
2013	Nissan Altima, 16k	82570	\$13,995	2011	Acura MDX, 48k	1321	\$23,459
2011	Honda Odyssey, 35k	036772	\$13,995	2010	Lexus LS 460, 39k	82704	\$31,995

MANY MORE LIKE THIS TO CHOOSE FROM!

**CLIP IT. BRING IT. CASH IN!**

UP TO **\$3,000**

- TOWARD THE PURCHASE OF ANY VEHICLE
- ADDITIONAL VALUE FOR YOUR TRADE • DOWN PAYMENT\*

Authorized Signature Required, General Manager

Must be presented prior to negotiations. Cannot be used for service or parts. Cannot be combined with other offers.

**Don't Make Your Next Payment Until You Speak To Us!**

**MAJORWORLD.COM**

1-877-625-6766 43-40 NORTHERN BLVD. LONG ISLAND CITY, QUEENS, NY 11101

**TIRED OF YOUR CAR? WE'LL BUY IT FROM YOU!™**

**CAR FOX** VEHICLE HISTORY REPORT

**TAKE THE R M SUBWAY TO 46TH ST STOP IN QUEENS**

Prices include all costs to be paid by the consumer except for license, registration & taxes. Used vehicles have normal wear, tear & mileage, some may have scratches & dents. ††All applications will be accepted. Severity of credit situation may affect down payment, APR & terms. Bankruptcies and liens must be discharged. \*Voucher available on vehicle purchase of \$10,000 or more. ^Slight h2o damage. \*\*Vehicle must be in safe operating condition, dealer not responsible for excess wear and tear. ^^Available with purchase, while supplies last. Some exclusions may apply, see dealer for details. Offers cannot be combined. NYC DCA#200342, DMV#711789.

PURCHASE A VEHICLE BETWEEN 9AM-5PM FROM NOW UNTIL MONDAY AND RECEIVE A GIFT ON US OF EITHER AN IPOD, NAVIGATION, CAR ENTERTAINMENT SYSTEM or BLUETOOTH KIT... COMPLIMENTS OF MAJOR WORLD!^^

<p>'11 HYUNDAI SONATA <b>\$8,995</b> Auto, 4 cyl, A/C, p/opts, 32k miles, Stk#1616 PLUS TAX &amp; TAGS</p> 	<p>2013 CHEVY MALIBU BUY FOR: <b>\$99</b> PER MO./72 MOS @ 1.99% APR W/ \$2995 DOWN PLUS TAX &amp; TAGS Stk# 1382, 3k mi.</p> 	<p>2013 TOYOTA COROLLA S BUY FOR: <b>\$103</b> PER MO./72 MOS @ 1.99% APR W/ \$2995 DOWN PLUS TAX &amp; TAGS Stk# 2595, 19k mi.</p> 	<p>2012 HONDA ACCORD LX BUY FOR: <b>\$115</b> PER MO./72 MOS @ 1.99% APR W/ \$2995 DOWN PLUS TAX &amp; TAGS Stk# 82471, 32k mi.</p> 
<p>'12 CHEVY CAMARO <b>\$14,995</b> Auto, 6 cyl, A/C, p/s, p/b, 42k miles, Stk#1196 PLUS TAX &amp; TAGS</p> 	<p>2013 DODGE GR CARAVAN BUY FOR: <b>\$12,995</b> PLUS TAX &amp; TAGS Stk# 3793, 43k mi.</p> 	<p>2011 HONDA PILOT LX BUY FOR: <b>\$14,995</b> PLUS TAX &amp; TAGS Stk# 5210, 23k mi.</p> 	<p>2011 MERCEDES C300^ BUY FOR: <b>\$18,995</b> PLUS TAX &amp; TAGS Stk# 68924, 13k mi.</p> 
<p>'12 HONDA CIVIC <b>\$10,995</b> Auto, 4 cyl, A/C, p/s, p/b, 31k miles, Stk#5650 PLUS TAX &amp; TAGS</p> 	<p>'10 TOYOTA RAV4 4WD <b>\$9,995</b> Auto, 6 cyl, A/C, p/s, p/b, 16k miles, Stk#73241 PLUS TAX &amp; TAGS</p> 	<p>2013 FORD EXPLORER BUY FOR: <b>\$21,895</b> PLUS TAX &amp; TAGS Stk# 2398, 34k mi.</p> 	<p>2011 MERCEDES ML-350 BUY FOR: <b>\$25,995</b> PLUS TAX &amp; TAGS Stk# 5589, 25k mi.</p> 
<p>'12 TOYOTA CAMRY <b>\$10,995</b> Auto, 4 cyl, A/C, p/s, p/b, 21k miles, Stk#84619 PLUS TAX &amp; TAGS</p> 	<p>'11 TOYOTA SIENNA <b>\$14,995</b> Auto, 6 cyl, A/C, p/s, p/b, 15k miles, Stk#73236 PLUS TAX &amp; TAGS</p> 	<p>2013 BMW 328xi BUY FOR: <b>\$25,995</b> PLUS TAX &amp; TAGS Stk# 3881, 18k mi.</p> 	
<p>'13 NISSAN ROGUE <b>\$15,995</b> Auto, 4 cyl, A/C, p/s, p/b, 5k miles, Stk#3428 PLUS TAX &amp; TAGS</p> 	<p>2010 LINCOLN MKS BUY FOR: <b>\$15,995</b> PLUS TAX &amp; TAGS Stk# 4985, 69k mi.</p> 	<p>2011 BMW 328xi BUY FOR: <b>\$18,995</b> PLUS TAX &amp; TAGS Stk# 661029, 32k mi.</p> 	<p>2011 INFINITI M37 BUY FOR: <b>\$23,995</b> PLUS TAX &amp; TAGS Stk# 1237, 27k mi.</p> 
			<p>2011 INFINITI G37 BUY FOR: <b>\$23,995</b> PLUS TAX &amp; TAGS Stk# 1414, 13k mi.</p> 

# Have You Been In An Accident?

## *You May Be Entitled To Money Damages!*

Car Accident Cases • Slips & Falls • Construction Accidents  
Work Place Accidents • False Arrests • Medical Malpractice



**JAMES ROSS**  
35 years experience

**WILLIAM C. THOMPSON**  
Ret. Justice Supreme Court  
Appellate Division Of Counsel To the Firm  
Former NYS Senator  
Former Regional Director NAACP

**ARTHUR HILL**  
35 years experience

**We have recovered millions of dollars for our clients.\***

**FREE Consultation • NO FEE Unless Successful**

# Ross & Hill, Esqs.

**Your local community lawyers for the past 35 years!**

**718-855-2324**

16 Court Street, 35th Floor  
Brooklyn, NY 11241

Se Habla Español

[www.rossandhill.com](http://www.rossandhill.com)

\*Prior results do not guarantee a similar outcome - expenses payable at conclusion of case

# 7 beauties vie for Miss New York

By Nelson A. King

Seven Caribbean beauties will vie this Saturday evening for Miss New York Continental 2014 at George Wingate Campus in Brooklyn.

The contestants will be representing St. Vincent and the Grenadines (Shereescia Browne); Tobago (Jadini Phillips); Grenada (Imani Peterson); New York Elite (Joseanne Harper); Barba-

dos (Drina Akuetarie); St. Lucia (Kelly Indy Smith); and Trinidad (Aaniya Johnson).

Miss Jamaica, who was initially slated to appear in the pageant, will not be doing so, according to Yvonne Peters, the Vincentian-born president of the organizing group.

"At this moment, the committee for the Caribbean American Cultural

Group, Inc. is working diligently to ensure that our audience enjoys the Miss New York Continental 2014 Pageant," Peters told Caribbean Life.

"Our contestants are from our community right here in New York, yet representing islands from the Caribbean through prenatal heritage, Caribbean or U.S. born," she added, stating that the young ladies will

make three appearances in which "they will eloquently display grace, poise and knowledge with swim wear, talent and evening wear."

Peters said the beauties will end the evening with an interview from a panel of judges.

Doors open at 5:00 p.m. at George Wingate Campus, 600 Kingston Ave, behind Kings County Hospital Center.



Yvonne Peters (L) and Dr. Roxie Irish (R) with contestants for Miss New York Continental Pageant 2014. Miss Jamaica, Eddine Sampson, has dropped out of the competition.

Photo by Nelson A. King

## Winter Clearance Sale

### DRESSES

\$50, \$100 & up

Prom Dresses  
Sweet 16 Dresses  
Evening Gowns  
Bridal Veils  
Mother Of The Bride  
Accessories

EVERYTHING  
MUST GO!

*Charm Fashion*

8023 5th Avenue • Bay Ridge  
(between 80 & 81 St.)

**(347) 560-6534**

ask for Alyse

## LOSE 3-9 INCHES IN 2 WEEKS, NON-INVASIVE!

"What if I told you this cutting-edge device could melt inches off your waist and keep them off for good."

— Doctor Oz

talking about the ZERONA® LipoLaser



Introducing ZERONA® LipoLaser — removes fat without surgery, pain or wounds. ZERONA® is a new body-sculpting procedure designed to remove fat and contour the body without invasive surgery. ZERONA® allows you to continue your daily activities without interruptions from surgery, pain or wounds. ZERONA® works by utilizing the Low Level Laser (FDA cleared for laser body contouring to emulsify fat which then releases into the interstitial space. The excess fat is passed through the body during its normal course of detoxification.

The ZERONA® procedure was proven through a double-blind, randomized, multi-site, and placebo controlled study in which patients average loss of 3.64 inches, and some lost as much as 9 inches compared to the placebo group that lost only half an inch.



**What you can expect:** Our patients lose an average of 8-9 inches from the waist, hips and thighs and reduction in clothes size in **2 weeks**. This is not a quick weight loss program — we are targeting adipose tissue and not taking off excess water weight. Results vary individually.



ZERONA®  
Laser  
of New York

www.zeronalaserofnewyork.com

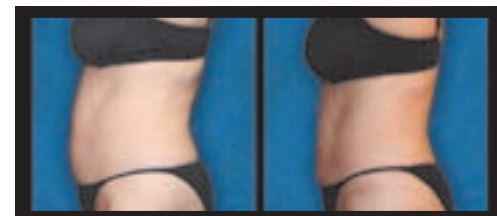

## ZERONA® WORKSHOP

When: Tuesday, June 17th, @ 2pm

Where: ZERONA® Laser of New York • 5911 16th Avenue, Brooklyn, NY

Cost: FREE (\$79 value) • Call: (718) 234-6212

**Caribbean Life**

For News,  
Entertainment &  
Sports Coverage

To Advertise  
Call Jennifer  
718.260.8302

# 'My Jamaica!' Festival now includes storytelling

Familiar Jamaica terms such as Aunty Roachie – (Miss Lou character) Dutchie (cooking utensil made of iron) and Ska, names three festivals that will be incorporated to make this year's Jamaica Festival a more diverse island-wide celebration.

Extended to run from June to Independence Day in August, national Emancipation and Independence event were detailed recently when Lisa Hanna, the island's minister of culture announced the theme for 2014 would be "This is Jamaica ...My Jamaica."

A new feature of the festival is the introduction of the Aunty Roachie Festival. Named for the character created by poet/actress/folklorist Louise Bennett, this aspect is tailored 'to showcase the storytelling talent of Jamaica Literary, Film and Television communities.' Aunty Roach Festival will feature: a short film competition, trailers from new television program, a



## Inside Life

By Vinette K. Pryce

book fair, poetry reading and storytelling.

An appeal for submission of scripts for the short film competition will open the competition to everyone who make applications at [www.cptcjamaica.com](http://www.cptcjamaica.com)

Hanna said the redesigned program also includes the Heart of Ska International Festival and the Dutchie Culinary Festival which will add music and cooking to the major festival. Also making a debut are Live Music Tuesdays, National Independence Exhibitions and Independence Signature Conversations — which will reflect the government's determination to enhance the contribution of culture and the creative industries to the national economy.

The most major change to the annual Jamaica Festival

program is that the celebrations of Emancipation and Independence which usually refers to the week of celebration from July 31 to Aug. 6, Independence Day is now extended to brand Jamaica Festival a season of activities beginning in June.

The redesigned Jamaica Festival includes an expansion of activities to incorporate most areas of the Cultural and Creative Industries including literature, film, television, culinary arts and fashion. The program also increases focus on parish and community activities in order to widen the identification, development and showcasing of talent island wide. In this regard, the ministry is introducing the Big Stage - a talent search competition at the community and parish levels which

will provide unprecedented exposure for creative talent and present an opportunity for development through the JCDC's new artiste management program.

"In the spirit of not leaving our cultural development to chance, we have made the strategic and deliberate decision to enhance the Jamaica Festival program by reviving, revitalizing and adding new activities to the season of celebration and reflection. Culture is an economic catalyst that we must maximize for the benefit of our people."

Hanna said that Jamaica Festival would continue to ensure that Jamaicans "never forget the ancestors who fought for and attained our Emancipation and our Independence" and be "inspired by their example of triumph in the face of adversity".

The minister said that the celebrations would also be used to emphasize the importance of family values through the first ever

National Family Day.

"I really wanted to do this as a way of helping to heal the Jamaican family. Many of the challenges that our children face are directly related to problems in the homes. If we can fix the families, we will fix Jamaica."

National Family Day is set for Aug. 2. Hanna is encouraging families, particularly those who have never had a reunion, to use the opportunity to connect to their roots and "to bolster the ties that bind."

Additionally, Hanna appealed for support of the reintroduced Independence Ball which will be a major fundraising event to improve conditions for Children in State Care.

A statement of solidarity with the people of Nigeria was issued on behalf of the government. The statement referenced the kidnapping and hostage holding of schoolchildren by terrorists.

## CARIBBEAN HERITAGE MONTH OFFERS SOMETHING POSITIVE & BRAATA

Something Positive -- acclaimed as New York's premier Afro-Caribbean performing dance company -- slates a number of events to mark Caribbean Heritage Month. Under the artistic direction of Michael Manswell, two back-to-back weekend engagements promise high energy activities at Jazz at Lincoln Center on June 14 when a Pan-Jazz performance bills Tales from the Silk Cotton Tree. The following day, Long Island University's Kumble Theater is the venue for another spectacular Brooklyn showcase. The following weekend, two fundraising events -- designed to bolster support for their public performances, educational programs and improvement projects -- promise an all-white summer fete on June

Continued on Page 39

A Guaranteed Memorable Experience...

# TOO BIG TO MISS

## SUN. JUNE 29<sup>th</sup>

# AIR SUPPLY

# BERES HAMMOND

# CHRONIXX

# MARCIA GRIFFITHS

CELEBRATING 50 YEARS IN MUSIC WITH HER FRIENDS

JUDY MOWATT • BOB ANDY  
JOHN HOLT • JUST ADDED L.U.S.T

GATES OPEN 12 NOON • KIDS 12 & UNDER FREE\*

# ROY WILKINS PARK

MERRICK & BAISLEY BLVD. QUEENS NY

Tickets can also be purchased online @

[WWW.GROOVININTHEPARK.COM](http://WWW.GROOVININTHEPARK.COM)

KIDS 12 & UNDER FREE\* GENL. ADM. \$59.99 VIP & VVIP CALL FOR INFO

**GENERAL INFO: 347.980.2252**

# ENTERTAINMENT

FOR MORE ENTERTAINMENT, GO TO CARIBBEANLIFENEWS.COM/ENTERTAINMENT

## Launch of fashion and accessory designs

By Tangerine Clarke

Janice Lawrence Clarke, fashion connoisseur and creative director of JLC Productions was elated that her 30-year dream to market Caribbean-heritage fashion and accessory designers in the U.S. became a reality when the Caribbean American Fashion Exchange (CAFE) initiative was launched with great fanfare.

The social entrepreneur partnered with the Caribbean Tourism Organization Foundation on June 5 at a fundraising reception during Caribbean Heritage Week, and promised that CAFE will provide a forum for the region's creative industries to engage the North American market.

Wearing a creation by Meiling, a fellow Trinidad and Tobago-born professional, Lawrence Clarke expressed her eagerness to showcase Caribbean coutu-



Barbadian-born Dexter John designer of John1NY and EMK Espadrille shoe designer Willem Germany with Janice Lawrence Clarke (center).

Photo by Tangerine Clarke

riers through a variety of programs that would help them to build their brands.

The eloquent fashion expert that was applauded by the Diaspora for her brilliant concept, said the door is open for Caribbean nationals to share "our vibrant, culturally-rich heritage. It is time

Continued on Page 38

## Battle 'On Broadway'

By Vinette K. Pryce

Hinton Battle stopped into New York's hottest nightspot for one night and there at 54 Below delivered classic, jazz and blues. Billed for a singular engagement to pay homage to jazz legends the likes of Dizzy Gillespie, Miles Davis, Duke Ellington, Nat King Cole and others the three-time Tony winner sampled a track from his stint along the Great White Way to sing "Sophisticated Ladies."

Although he limited his repertoire by performing a varied set of classic jazz selections, he also delivered "Caravan," "On Broadway," "Night In Tunisia," "Ellie my Love" and "Welcome to the Club"

and with those selections included a sampling of blues and scat.

Fresh from a three-month stint in Japan where he performed in Osaka and Tokyo, the acclaimed singer, dancer, choreographer, producer and director knows no boundaries.

Needless to say Battle was delightful. From the very start of the set, his stamina, energy and personality set the tone for a stimulating and enticing session that was filled with surprises and unexpected treats. Joined on this cabaret outing by his traveling companions - Lee Pearson on drums, Terry

Continued on Page 38

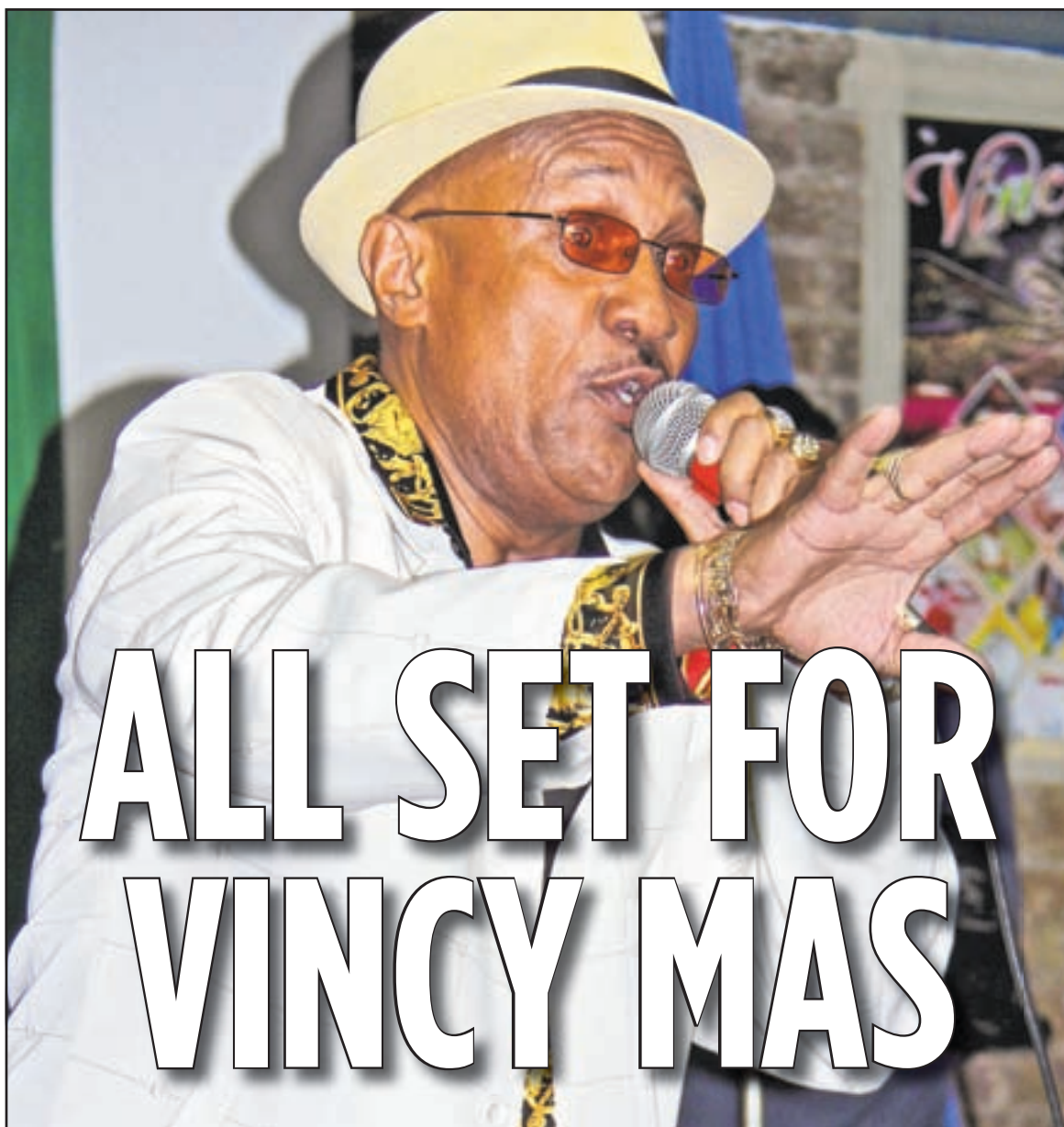

Exposer (Earl Isles) performing at the Café Omar in Brooklyn.

Photo by Nelson A. King

## New York Calypsonians in top gear

By Nelson A. King

With relatively very good weather – and the temperature in the Dynamite Calypso Tent just right, unlike last year when it was sweltering hot – Vincentian calypsonians in North America last Saturday night/Sunday morning clearly demonstrated that they were quite ready to take VincyMas 2014 by storm.

The artistes and die-hard fans

were also not deterred by any flash floods warnings, as was the case last month, when the New York Dynamite Calypso Tent was launched.

A dozen calypsonians showed up last weekend at Café Omar in Brooklyn to compete in the preliminary round judging for VincyMas 2014. Only half that number had participated in the launch at the Matrix Lounge, on Ave. H, in Brooklyn.

The lyrics, melody, rendition, presentation, originality and crowd response were described as very impressive, as calypsonians gave calypso fans their "money's worth" during the judging segment of the four-hour-plus long show, which began around 12:30 Sunday morning.

Three judges from the local  
Continued on Page 38

# ‘So What?’ about the Environment

## Student Activism through the Arts

By Shari Logan

An art exhibit called “So What?” focusing on the environment, which was created entirely by students from two Bedford Stuyvesant schools is sure to make an impact beyond the walls of the Museum of Contemporary African Diaspora Arts [MoCADA] where it is on display.

Students like seven-year-old Sarah Christie of P.S. 3 --The Bedford Village School that has a population of up to 70 percent, with students of Caribbean descent -- according to school administrators, has influenced her mom to be more environmentally conscious.

“She turns off the lights in the house and when I

went to put foil in the garbage, she said: ‘No Mommy, we have to recycle’” said Jamaican native Nadia Christie at the opening celebration for the exhibition on May 21.

Sarah along with her sister Katherine, 9, and 23 other classmates in grades one through five from the Bedford Village School, cre-

ated a map made of scrap paper. For example when construction paper was used to make letters for signs encouraging students to recycle or save energy, the remaining paper was torn off and put in a blender with some water. Then the excess water was drained and the new paper was flattened, dried and used for various



Art students in the MoCADA program Photo by Shari Logan

## PROVODNIKOV vs ALGERI

**WBO JUNIOR WELTERWEIGHT CHAMPIONSHIP OF THE WORLD**  
**SATURDAY, JUNE 14, 2014 | BARCLAYS CENTER**  
 DOORS OPEN @ 6PM | FIRST BOUT @ 7PM

**WBO CHAMPION**  
**RUSLAN**  
**PROVODNIKOV**  
 23-2 16KO's  
**BERYOZOYO**  
 RUSSIA

**UNDEFEATED**  
**CHRIS ALGERI**  
 19-0, 8 KO's  
**HUNTINGTON**  
 NEW YORK  
 U.S.A.

---

**WBO JUNIOR MIDDLEWEIGHT CHAMPIONSHIP OF THE WORLD**

**WBO WORLD CHAMPION**  
**ANDRADE**  
 NO. 1 CONTENDER  
**VS**  
**ROSE**

**DEMETRIUS "BDD BOO" ANDRADE**  
 20-0 13KO's - PROVIDENCE, RI

**BRIAN "THE LION" ROSE**  
 25-1-1 7KO's - BLACKPOOL, UK

**ACTION PACKED UNDERCARD BOUTS**

Long Beach's <b>"IRISH" SEANIE MONAGHAN</b>	Brooklyn's Own <b>HEATHER "THE HEAT" HARDY</b>	2012 Bronze Medalist <b>TABAS SHELESTYUK</b>
--	---	---

**TICKETS ON-SALE NOW: \$31 | \$56 | \$86 | \$106 | \$206**  
 BY PHONE: CALL 800-745-3000 | ONLINE: BARCLAYSCENTER.COM | TICKETMASTER.COM  
 IN PERSON: AMERICAN EXPRESS BOX OFFICE @ BARCLAYS CENTER | M-F 12PM-6PM | SAT. 12PM-4PM

ALL BOUTS SUBJECT TO CHANGE WITHOUT NOTICE

designs.

“I feel proud that I’m in a museum. I’m also proud that we created the globe together. I like helping the planet by recycling. I recycled cans, foil, and milk cartons. This experience with MoCADA was very fun,” said Katherine.

The exhibit is the result of the Artist in the Schools (A-I-S) program that is made possible by an Afterschool Activities (CASA) grant from the NYC Department of Cultural Affairs. MoCADA has participated in the program for the past 10 years. Teaching artists Joseph Zoboi and M. Scott Johnson worked with students from the Bedford Village School and M.S. 57 Ron Brown Academy respectively for 25 weeks.

“So What?” also features a photo composite technique that Johnson, a sculptor of 20 years, created himself and used with 15 eighth-grade students. Although he has great knowledge of the world of art, he said that at times he became the student.

“I may be teaching them but I’m learning simultaneously. I look at them as fellow artists, not children, because they have a stroke of genius now that I don’t have,” said Johnson who has taught in the A-I-S program for four years.

People will approach the exhibit because there is a familiarity with it. The students took a leap in how they looked at the Environment theme. We have pictures with [bottles of antidepressant] Prozac. Some of the kids complain that the medication [they are prescribed] makes them sleepy or that the foods in their community are unhealthy and the photography shows that. They are more mature

than you think.”

In fact, student artist Ericson Lewis, 14, of M.S. 57 Ron Brown Academy came up with the concept for the photo composite that features foods like an apple or fish and tools such as nails. He said that nails represent the harsh chemicals that are killing our foods.

“The program was lovely. I was inspired to continue creating artwork. I want to inspire other people to feel happy and eat healthy,” said Lewis.

Parent Adia Music was both happy and thankful about what she saw in the student art exhibit.

“It’s visually stimulating. There are students in art schools who can’t come up with some of these concepts. This is powerful and not as mundane as what other museums have. A lot of artists are trying to mask reality so they can become commercial. This says ‘Wake up!’ ‘Wow, thank you to [MoCADA and teachers] for guiding our youth.’”

MoCADA Education Director Morgan Parker is excited about the impact this experience will have in the lives of the students.

“This year the students became extremely invested in the environment, and used the arts as a way to express their activism. It was so exciting to watch them find new ways to think about climate change, sustainability, and how to make an impact in their communities. For many students, the program provided a spark for lifelong environmental activism,” Parker said.

“So What?” runs through July 27 at MoCADA which is located on 80 Hanson Pl. in Brooklyn. For more information, visit <http://mocada.org>.

# Tom Cruise rises to the occasion as reluctant hero

*"Edge of Tomorrow"*  
**Excellent (4 stars)**  
**Rated PG-13 for profanity, intense violence and brief sensuality**  
**Running time: 113 minutes**  
**Distributor: Warner Brothers**

## By Kam Williams

William Cage (Tom Cruise) is lucky to have risen to the rank of Major in the U.S. Army without ever seeing any combat, since he can't stand the sight of blood, not even a paper cut. So, you can imagine his surprise the day that he's informed by his superior (Brendan Gleeson) that he'll be shipping out soon to England to lead a D-Day style invasion of France. The aim of the mission is to take back Western Europe from an army of intelligent alien invaders called Mimics because of

an uncanny ability to stage sophisticated counterattacks.

When Cage attempts to decline the dangerous assignment, General Brigham explains that he's just been given an order, not an offer. And when he still proves reluctant to obey, he is summarily stripped of his stripes and forced to join a motley unit of troublemakers known as J Squad, operating under the command of a no-nonsense sergeant (Bill Paxton) capable of keeping anybody in line.

Shortly thereafter, they ship out aboard a plane as part of an international squadron of troops which proceeds to parachute onto a beach that looks like a slaughterhouse. The allies' firepower is being easily overmatched by that of the enemy, and it isn't long before Cage takes a fatal shot to the chest.

However, he is dead only briefly before finding himself transported back in time to the moment he met Sergeant Farrell a few hours before, when he was roused out of a stupor



Tom Cruise as William Cage and Emily Blunt as Rita Vrataski in "Edge of Tomorrow."

by the Southerner's thick drawl of "On your feet, maggot!" Somehow, Cage has been given a reprieve, a second chance to exhibit expertise and heroics on the battlefield. In fact, he is subsequently killed again and again and, like your typical computer game, is thereby afforded

umpteen opportunities to start over and improve his strategy against the seemingly-invincible Mimics.

Cage is ably assisted in this endeavor primarily by Special Forces soldier Rita Vrataski (Emily Blunt), aka the Full Metal Bitch, the only other person aware of his

recently-acquired ability to reincarnate. Therefore, it falls to these two strangers to save the planet from the alien scourge bent on world domination.

Thus unfolds Edge of Tomorrow, a mind-bending sci-fi based on All You Need Is Kill, a graphic novel originally published by Hiroshi Sakurazaka in Japan in 2004. Directed by Doug Liman (Mr. & Mrs. Smith), this action-oriented thriller revolves around a plot device famously explored in both Groundhog Day (1993) and Source Code (2011).

Nevertheless, Liman has put a refreshing spin on the time machine genre, and keeps you enthralled by holding his cards close to the vest as he keeps you guessing about the series of thoroughly unpredictable developments that transpire. Just when everybody was ready to count Tom Cruise's career out for the count, not only is he back, but back again and back again and back again, ad infinitum!

## Independent & Foreign Films

The Amazing Catfish (Unrated) Strange bed-fellows dramedy about a lonely supermarket clerk (Ximena Ayala) with appendicitis who finds herself befriended by her hospital roommate (Lisa Owen) and family. Support cast includes (Sonia Franco, Wendy Guillen and Andrea Baeza). (In Spanish with subtitles)

Burning Bush (Unrated) Czech docudrama, set in 1969, chronicling the student protests of the Soviet invasion of Prague launched by a martyr who set himself on fire. Starring Tatiana Pauhofova, Jaroslav Pokorna and Petr Stach. (In Czech with subtitles)

A Coffee in Berlin (Unrated) Tragicomedy about a just-jilted college student (Tom Schilling) who drops out of school after being cut off financially by his father (Ulrich Noethen) only to end up aimlessly wandering around the streets of Berlin. With Katharina Schuttler, Andreas Schroders and Marc Hosemann. (In German and English with subtitles)

Evergreen (Unrated) Cannabis documentary



## Kam's Kapsules

By Kam Williams

examining the state of affairs in Washington after the legalization of the recreational use of marijuana.

Hellion (Unrated) Dysfunctional family drama about a juvenile delinquent (Josh Wiggins), being raised by an emotionally-distant, widowed dad (Aaron Paul), whose anti-social behavior leads Child Protective Services to award custody of his imperiled little brother (Deke Garner) to their very protective aunt (Juliette Lewis). Support cast includes Augustine Frizzell, Jonny Mars and Annalee Jeffries.

I Am I (Unrated) Father-daughter drama about the frustrations encountered by a young woman (Jocelyn Towne) who belatedly befriends the brain-damaged dad she's never known (Kevin Tighe) when he shows up unexpectedly at her mother's funeral. With Simon Helberg, Jason Ritter and James Morrison.

Ivory Tower (Unrated) Education expose' questioning whether a U. S. college degree is still worth the investment.

The Rover (R for profanity and gory violence) Post-apocalyptic drama, set in the Australian Outback a decade after the collapse of civilization, about a hard-boiled army vet's (Guy Pearce) search for the gang of criminals that stole his only possession. With Robert Pattinson, Scoot McNairy and David Field.

See You Next Tuesday (Unrated) Dysfunctional family dramedy, set in Brooklyn, about an unemployed, pregnant woman's (Eleanore Pienta) toxic relationships with her mother (Dana Eskelson), her lesbian sister (Molly Plunk), and her sister's live-in lover (Keisha Zollar). Support cast features Taylor Dior, Stephan Goldbach and Michele Meises.

Continued on Page 39

**SISTAS**  
*the Musical*

**3RD SMASH YEAR**

*A joyful musical celebration of life, love and family!*

**"Sweet & Sassy!"**  
 - NY Times

**"A Marvelous Time!"**  
 -Amsterdam News

**"A Winner!"**  
 -NY Beacon

**I AM NOT MY HAIR**

**SINGLE LADIES**

**RESPECT**

**OH HAPPY DAY**

**TYRONE**

St. Luke's Theatre, 308 W 46th St  
 Telecharge.com • 212.239.6200 • SistasTheMusical.com  
 Special rates for groups call 212.977.5925

Go to [www.Caribbeanlifeneews.com](http://www.Caribbeanlifeneews.com) for the latest in Caribbean news, entertainment, sports, business, viewpoints and more.

## TOP OF THE CHARTS

### TOP 10 SINGLES

- 1 **All Of Me**  
John Legend
- 2 **Not A Bad Thing**  
Justin Timberlake
- 3 **Fancy**  
Iggy Azalea Featuring Charli XCX
- 4 **Happy**  
Pharrell Williams
- 5 **Ain't It Fun**  
Paramore
- 6 **Dark Horse**  
Katy Perry Featuring Juicy J ..
- 7 **Problem**  
Ariana Grande Feat. Iggy Azalea
- 8 **Turn Down For What**  
DJ Snake & Lil Jon
- 9 **Summer**  
Calvin Harris
- 10 **Sing**  
Ed Sheeran

### TOP 10 ALBUMS

- 1 **Ghost Stories**  
Coldplay
- 2 **The Secret (EP)**  
Austin Mahone
- 3 **Me. I Am Mariah... Elusive**  
Mariah Carey
- 4 **Just As I Am**  
Brantley Gilbert
- 5 **Frozen**  
Soundtrack
- 6 **Do It Again (EP)**  
Royksopp & Robyn
- 7 **Turn Blue**  
The Black Keys
- 8 **The New Classic**  
Iggy Azalea
- 9 **Neon Steeple**  
Crowder
- 10 **Below Paradise**  
Tedashii

Presented by  
**verizon**wireless

# Dynamite Calypso

Continued from page 35

Calypso association – Earl Paynter, Eustace Maloney and Aubry Gould – as well as the association's Canouan-born president, Ann Miller, were on hand to eventually determine who will compete in the semifinal round in VincyMas, on June 27, dubbed “Fantastic Friday.”

An admixture of calypso veterans and relative newcomers provided long-anticipated entertainment to the very appreciative crowd, as they vied for a coveted place in the “semis.”

Former national calypso monarch De Man Age (Errol Rose), Exposer (Earl Isle), Rejector (Carlos Providence), Groovy D (Vincent Kennedy), Dennis Bowman, John Dougan, Jose Juan (Ramon Diaz), Detector (Delano Joseph), Chang I (David Morgan), Bob MC (Mervin Bobb), Singing Della (Delanti Isle) and Jakie (Kenroy Jack) raised the bar, at least by a notch, according to Ainsley Primus, president of the

Dynamite Calypso Tent.

“The standard this year went up a notch compared to last year,” he told Caribbean Life in a post-show interview.

“The calypsonians, their attire, their standards, were very high,” he added. “They set the standard about how they portrayed themselves. The crowd responded very well.”

“Some fans believe we definitely have at least five (calypsonians) in the semifinals,” Primus continued. “Others think we will get between five and seven.”

Paynter told Caribbean Life that the semifinal picks will be determined after adjudication of the four local tents earlier this week.

He said a total of 22 calypsonians, with two reserves, will be chosen for “Fantastic Friday” at Carnival City, Victoria Park.

Three-time national calypso monarch De Man Age urged that it was time to “Tek Back We Country”, claiming “they treating we



Dennis Bowman of the Dynamite Calypso Tent compete in the preliminary round judging for VincyMas 2014. Photo by Nelson A. King

like step child”; Exposer, rendering “Yankee Man,” said “the corruption I seeing/You have to agree/All yo more Yankee than me”; Rejector said he was delighted that there would be “No Excess Baggage”, when the Argyle Inter-

national Airport becomes fully operational, adding: “the airport is for all ah we”; and Groovy D, who suffered a stroke last year and performed with a cane, said “You Never Know” what can happen in life.

## Designs

Continued from page 35

that we put into practice economic empowerment through cultural development.

She lauded the likes of Adolfo of Cuba, Francis Hendy of Trinidad, Carolina Herrera of Venezuela and Oscar de La Renta of the Dominican Republic, for reaching international acclaim.

However, the fashion forward professional would like to see other talented Caribbean designer grasping the elusive fame that would allow them to reach the pinnacle of fashion in America.

Fully supported by the CTO Foundation, chairman Jacqueline Johnson drew parallels between the two entities, saying, “both entities have at their core, identifying and developing the best and the brightest from the Caribbean to assure prominence in their field of endeavor.

“We applaud the work of JLC PProductions on the CAFE initiative and look forward to continuing to collaborate on future activities that rebound to the benefit of the Caribbean and Caribbean peoples.

Sylma Brown Bramble, director at the Caribbean Tourist Board, and a board member of the CTO Foundation, added that because CTO



Models wearing designs by Coat of Arms and John1NY with creative director of JLC Productions Janice Lawrence Clarke (center)

Photo by Tangerine Clarke

engages the Diaspora and Janice is active in the Diaspora, “I thought CAFE would be and interesting project to be involved with.”

“With the launch of CAFÉ, and partnership with CTO we are excited to foster Caribbean American fashion designers who for some reason are not recognized in the U.S. We will represent these designers that are more known in the Caribbean, and give them a U.S. presence,” said Mitria Di Gacomo, brand maven and president of Nexus Plexus.

Barbadian-born Dexter John of John1NY collection showcased samples of his male vintage inspired style that he described as authentic and detailed.

Models also displayed pieces from Coat of Arms – a luxury fashion and accessories brand collection inspired by Caribbean travel.

## Broadway

Continued from page 35

Brewer on piano, Samir Moulay, on guitar and Romeir Mendez on bass they provided a full complement to accompany his incomparable performance.

Scatting and gyrating to an infectious beat, Battle's first treat introduced Chloe Arnold, a tap dancer Gregory Hines would have approved. More in step with the stylings of latter day tap dance kid Savion Glover, Arnold showcased skill and talent by parodying the sounds of Battle and musical accompaniment by musical director Pearson.

A big surprise introduced three-time Grammy winner Dee Dee Bridgewater who was urged onstage to join him in singing the standards they seem to enjoy.

The accomplished jazz singer pleaded against a performance saying she was out to hear Battle sing but yielded when an enthusiastic crowd demanded the collaboration.

Before agreeing to the duet Bridgewater shared a story of the union she enjoyed while she was in Japan. After many years, it seems they found themselves in Asia and together re-bonded at an international jazz festival.

Hinton and Bridgewater sang “Bye Bye Backbird.”

The unrehearsed, impromptu duet treated patrons to a rendition

from two acclaimed Tony award winning song stylists. Together the three-time Tony award winner and his special unexpected guest reprised a classic patrons seemed to indulge with appreciation and nostalgia.

On that evening Battle also launched his three-CD compilation “Something New” which features a sampling of blues, Broadway and jazz.

“I've listened to Hinton first three songs -- “All Blues”, “On Broadway”, and “Sophisticated Lady,” Dee Dee Bridgewater said.

“I really like the arrangements and.... I love it.”

During the 90-minute set, he took time out to talk about his early retreat from his home-base of Washington D.C. when he was just a boy. The brief reflection credited choreographers Geoffrey Holder, George Faison and others who encouraged him to finish his academic studies before pursuing dance. But dance was in his blood.

He said he walked “like a ballerina” and for a time auditioned to a single ballet command. And although Holder encouraged him to add more “sparkle” to the scarecrow he portrayed on Broadway when he debuted at age 15 in “The Wiz,” he has added his own panache and left an indelible imprint on audiences who saw him later in the “Tap Dance Kid.”

Go to [www.Caribbeanlifeneews.com](http://www.Caribbeanlifeneews.com)

# Films

Continued from Page 37

The *Signal* (PG-13 for violence, profanity and mature themes) Sci-fi thriller revolving around a couple of MIT freshmen (Brenton Thwaites and Beau Knapp) driving across the Southwest with a girlfriend (Olivia Cooke) who take an ill-advised detour in the desert at the sugges-

tion of a computer hacker with a hidden agenda. Featuring Laurence Fishburne, Robert Longstreet and Sarah Clarke. *Violette* (Unrated) Lesbian biopic about French novelist Violette Leduc (Emmanuelle Devos), a write remembered for her sexually-explicit passages and as the life mate of Simone de Beauvoir (Sandrine Kiberlain). With Olivier Gourmet, Catherine Hiegel and Jacques Bonaffe. (In French

with subtitles)

**BIG BUDGET FILMS**  
22 Jump Street (R for sexuality, violence, drug use, brief nudity and pervasive profanity) Jonah Hill and Channing Tatum reprise their roles as ill-matched LAPD partners, this time going undercover as college students to crack a narcotics ring operating on campus. With Ice Cube, Amber Stevens and Nick Offerman.

# Inside Life

Continued from Page 34

21. The chic summer event will begin at 9:00 p.m. at Brooklyn's newest hotspot located at 333 Flatbush Ave. With music an integral consideration, the all-white fete promises to be an electrifying night filled with sounds provided by renowned DJs, Strictly Noise and Freeze International. Sunday Soiree at Harlem's Strivers Row brownstone of art offers an exclusive day party hosted by art collector and gal-

lery owner Asake Bomani On June 22. The soiree will feature a performance by Something Positive, delicious cocktails, and a smorgasbord of African, Caribbean, and Asian inspired cuisine prepared by Bomani and Alexander Smalls, executive chef at Harlem's The Cecil Restaurant.

For more information visit [www.somethingpositiveinc.org](http://www.somethingpositiveinc.org)

Caribbean Heritage Month also returns BRAATA Folk Family with song, dance and comedic nostalgia from the region. On

June 21 at the Jamaica Performing Arts Center, 153-10 Jamaica Ave. in Queens, the cultural folk group will celebrate their fifth anniversary with revelry, beginning at 8:00 p.m. For more information, call 718-618-6170.

On June 22, the anniversary celebration moves to Long Island University's Kumble Theater, One University Plaza (Flatbush Ave. bet. Dekalb & Willoughby) for a 6:30 p.m. concert.

For more information, call 718-488-1624.

*Catch You On The inside*

# Turn your power on at Live Holistic



*Chiropractic & Holistic Care For Greater Health, Mobility, & Pain Relief*

**5 Essentials to Health • Nerve Supply • Exercise • Detox Time & Stress Management**

*Maximize Your Mind • Lean Muscle • Spinal Correction • Percussion Massage Whole Body Vibration - Boosts • Bone Density • Loosens Lower Back & Reduces Leg Pain*

**Full Examination w/ X-rays - only \$45.00**  
*Regularly \$350.00*

MOST INSURANCES ACCEPTED

*Not Insured? We Offer Affordable Payment Plans*

**Dr. Vincent Adamo**  
**718-921-5483**

446 Bay Ridge Parkway, Brooklyn, NY 11209

[www.liveholistic.net](http://www.liveholistic.net)

**CHIROPRACTIC CARE FOR HIGH SCHOOL ATHLETES & CHILDREN**  
*We Carry Homeopathics & Natural Vitamins*



# WIADCA

WEST INDIAN AMERICAN DAY CARNIVAL ASSOCIATION, INC.

## MAKE MUSIC NEW YORK

### SATURDAY JUNE 21ST 2014

*At* **RONALD MCNAIR PARK**  
(EASTERN PARKWAY BET. WASHINGTON & CLASSON AVENUE)

— FROM 2:00 PM TO 9:00 PM —

**LIVE ENTERTAINMENT & KIDDIES CARNIVAL PARADE!**  
SEEKING LOCAL ARTISTS TO PERFORM

FOR MORE INFORMATION CONTACT:  
WIADCA'S OFFICE @ (718) 467-1797 OR  
EMAIL: [wiadcainc@gmail.com](mailto:wiadcainc@gmail.com)

Media Partner **Caribbean Life**



**MAKE THIS A DAY TO REMEMBER!**

### ENJOY LIVE PERFORMANCES BY:

- LANI K
- MYSTIQUE
- LENNOX PICOU
- SURETTE BON BON
- BENJI C
- DESMOND
- MAJESTY
- KUF KNOTZ
- YAIQUAB
- N'YCE
- JOHNNY VOLTIK A.K.A. THE LEGENDARY MISFIT
- THADDEUS STRAUSS
- BOODOOSINGH TASSA DRUMMERS
- DAREDEVILS OF THE RED CIRCLE
- Jump up section BY DJ HARD HITTIN HARRY & EARTHMAN EXPERIENCE

# SUN KULCHA

## COMMUNITY EVENTS

**SAT., JUN. 14**

**TALK CARIBBEAN:** A better life for our people NY will host 'Talk Caribbean' in celebration of Caribbean Heritage month. The guest speaker of the evening will be Hon. Mia Amor Mottley, leader of the Opposition in Barbados at 5:00 p.m. There will be a pre-father's day 'Lime and Libation' immediately after the discussion. Adm: \$40 (All inclusive) For more information, please call Jerry (347)786-2973, Jessica (516)376-7779, Mike (646)825-1361, Sam (917)202-6736 St. Leonard's Church, 765 Putnam Ave., Brooklyn, NY 11221.

**CYCLE FEST:** PS 9 is hosting its first ever Cycle Fest from 10:00 a.m.- 3:00 p.m. They'll have a Bike Bonanza for kids, with Learn to Ride, Bike Swap and free Helmet Fittings provided by Bike New York, Recycle-a-Bicycle, and DOT! Bike events are FREE but require parent/guardian to be present; to pre-register for Learn to Ride visit: <http://www.bikenewyork.org/learn/kids/bike-bonanza/>

**THURS., JUN. 19**

**HOMEBUYERS:** The first step toward homeownership begins with education. Neighborhood Housing Services (NHS) of East Flatbush, a not for profit housing organization, is having a free homebuyer seminar. Learn about grants, affordable mortgages, closing cost assistance, building your homeownership team, and more. Time: 6:30 p.m. HSBC Bank, 1380 Rockaway Pkwy. (between Seaview & Ave. N) BK, NY 11236. To reserve space, call 718-469-4679 or email [infoef\\_01@nhsnyc.org](mailto:infoef_01@nhsnyc.org).

**ONGOING**

**FRI., MAY. 2 – SAT., JUN. 28**

**ART EXHIBIT:** Pelham Art Center is pleased to announce "Big, Fat & Juicy," a group show of large-scale abstraction that pushes the boundaries of the physicality of paint. Paintings and sculptures by four New York-based artists, Emily Noelle Lambert, Dorothy Robinson, Josette Urso and Deborah Zlotsky, combine the deliberate spontaneity found in abstract painting and the inventive possibilities of paint itself, which appear here in lush and expressive ways. Admission is free and open to the public. Pelham Art Center 155 Fifth Ave., Pelham, NY 10803. For more information, contact (914) 738-2525.

**WED., JUN. 11 – SAT., JUN. 14**

**PERFORMING ARTS:** Led by Israeli-born Artistic Director Zvi Gotheiner, ZviDance will premiere "Surveillance," a contemporary dance and multimedia piece that explores the realities behind the surveillance camera, at the New York Live Arts Theater, 219 W. 19th St., New York City. Performances: Wednesday - Saturday at 7:30 p.m. & Saturday at 2:00 p.m. Tickets are \$25 (\$18 for Live



## FARMER'S MARKET

**ONGOING:** Seeds in the Middle is sponsoring The Crown Heights Farmers Market offering fresh fruits and vegetables, including callaloo and Caribbean favorites and accepting EBT, WIC, Snap, FMNP, Health Bucks, and Fresh Connect. The market will be operating every Thursday from noon to 7:00 p.m. at Hamilton Metz Park at Albany and Lefferts avenues, Brooklyn. For more information, visit [www.seedsinthemiddle.org](http://www.seedsinthemiddle.org).

## FLOOD RELIEF

**ONGOING:** Donations are being accepted at the Friends of Crown Heights Center located at 671 Prospect Place, Brooklyn. Donations will also be accepted by Mirtha Colon, Checks and money orders are welcomed and should be made out to "SVG Community Inc." Anyone in the Long Island area who wishes to make a donation but cannot drive to Brooklyn, please call (347) 488-4395 to arrange a drop off or to arrange for Colon to pick up the donation. Items needed include medical supplies, non-perishable food, clothes, shoes, candles.

## COMMUNITY CENTER

**ONGOING:** Are you looking to improve your life? Take a class at Community Learning Center: How to Write a Book or Script, Create a Resume, How to Create Wealth, Get/Keep a Spouse, Start a Business. Classes for everyone. Community Learning Center, 147-12 Archer Ave., Queens. For more information/RSVP, call (718) 291-1094.

Arts members & associate artists, students and seniors) and are available at [newyork-livearts.org](http://newyork-livearts.org) or by phone at (212) 924-0077.

**INSURANCE POLICY:** Are you covered adequately by your homeowner's insurance? Are you paying too much? NHS will review your policy free of cost. We also speak to community groups about the how the changing flood maps will impact your policy and flood insurance. For more information, call (718) 469-4679. Sponsored by Neighborhood Housing Services of East Flatbush is a not-for-profit housing organization. [www.nhsnyc.org](http://www.nhsnyc.org).

**FLOOD RELIEF:** Donations are being accepted at the Friends of Crown Heights Center located at 671 Prospect Place, Brooklyn. Donations will also be accepted by Mirtha Colon, a Garifuna from Honduras, who operates Hondurans Against Aids out of Casa Yurumein in the Bronx. Casa Yurumein is located at 874 Prospect Ave. in the

South Bronx, corner of Westchester Avenue. Checks and money orders are welcomed and should be made out to "SVG Community Inc." Anyone in the Long Island area who wishes to make a donation but cannot drive to Brooklyn, please call (347) 488-4395 to arrange a drop off or to arrange for Colon to pick up the donation. Items needed include medical supplies, non-perishable food, clothes, shoes, candles. Monetary donations can be made in the form of checks or money orders addressed to "SVG Community Inc."

**PASSPORT APPLICATION CENTER:** Brooklyn Public Library (BPL) launched a second Passport Application Center at the Kings Highway Library providing a convenient facility for Brooklyn residents and new immigrants to apply for passports. Hours are temporarily set for 10:00 a.m. - 3:00 p.m. from Monday through Friday and Sunday by appointment. The Center is currently closed on Saturdays until further notice. The library is located at 2115 Ocean Ave.,

Brooklyn, NY 11229. To make an appointment, call (718) 230-2292 or (718) 375-3037 ext. 128.

**FEATURING HOME REPAIR:** Is your boiler, water main or roof in need of fixing? Do you need major repairs done but lack the finances? Now is the best time to fix it. Neighborhood Housing Services of East Flatbush, a not-for-profit housing organization can assist you. For more information on the Home Improvement Programs, call (718)469-4679 or visit [www.nhsofeastflatbush.org](http://www.nhsofeastflatbush.org).

**FORECLOSURE:** Are you behind in your mortgage or seeking a modification? Come in for free services and assistance. We will help you as much as possible to keep your home. Referrals for free legal assistance are also available. To schedule an appointment or for more information, call (718) 469-4679. Sponsored by Neighborhood Housing Services of East Flatbush and the Center for New York City Neighborhoods, not-for-profit organizations. [www.nhsnyc.org](http://www.nhsnyc.org).

**HOME HELP FOR DISABLED:** If you are a disabled homeowner living in Brooklyn or have someone disabled living in your household, you may qualify for up to \$5,000 in home repair grants. Repairs must be geared toward making the home accessible and convenient for the disabled person. Sponsored by Neighborhood Housing Services of East Flatbush, a not-for-profit housing organization, and the New York State Housing Trust Corporation. For more information, please call (718) 469-4679.

**COMMUNITY CENTER:** Are you looking to improve your life? Take a class at Community Learning Center: How to Write a Book or Script, Create a Resume, How to Create Wealth, Get/Keep a Spouse, Start a Business. Classes for everyone. Community Learning Center, 147-12 Archer Ave., Queens. For more information/RSVP, call (718) 291-1094.

**DONATIONS:** St. Robert Bellarmine Church is joining efforts with the Diocese of Trenton to bring relief to victims in the hardest hit areas. The church has organized a sorting sub station in the parish and will be delivering donations to various locations shortly. The church is seeking donations of cardboard shipping boxes for packing or rubber bins for storage for victims. Donations are tax deductible and the church will provide you with a receipt upon request. Feel free to contact St. Robert Bellarmine Church at any time Attn: SRB Hurricane Relief Effort, 61 Georgia Rd., Freehold, NJ 07728 or [srbwelcome@gmail.com](mailto:srbwelcome@gmail.com), Pam Stengel (732) 580-0075, Linda Altini (917) 578-4852. Phone: (732) 462-7429 or Fax: (732) 409-3496.

*If you have an event you would like to post in Sun Kulcha, please email your submission to [Caribbeanlife@cnglocal.com](mailto:Caribbeanlife@cnglocal.com). All submissions are subject to a review by the editor.*

*Compiled by Natalie Y. Henry*



# Shopping break.

A perfect moment to talk about alcohol.

An alarming number of pre-teens are drinking alcohol – which makes it urgent to find every opportunity to talk to your kids about the dangers of underage drinking. For tips on how – and when – to begin the conversation, visit:

[www.underagedrinking.samhsa.gov](http://www.underagedrinking.samhsa.gov)



# KINGS COUNTY CHRYSLER DODGE JEEP RAM HOSTS GIANT INVENTORY REDUCTION SALE!

## UP TO 30% OFF MSRP! 300 VEHICLES MUST GO! GOOD CREDIT, BAD CREDIT, GET APPROVED TODAY!

Brooklyn, NY – Local dealership, Kings County Chrysler Dodge Jeep Ram, is offering up to 30% off dealer list price\* on new Chryslers, Dodges, Jeeps, and Rams during their Spendless Summer Sales Event. Kings Chrysler Dodge Jeep Ram created this unprecedented event to give drivers the savings they deserve this summer!



To offer the best selection to customers, Kings County Chrysler Dodge Jeep Ram has a record number of new vehicles available, shipped in especially for this event. With OVER 300 PLUS vehicles priced for delivery, customers are sure to find the new vehicle they've been looking for and drive it home the same day.

*"We are so thankful for the fantastic customers we have," commented Alex Avrutsky, General Manager at Kings County Chrysler Dodge Jeep Ram. "During the Spendless Summer Sales Event, our goal is to help every single customer get on the road this summer without breaking the bank. That means an even bigger savings and bigger selection than usual!"*

Whether customers are looking for a family sedan, fuel efficient crossover or powerful SUV, they can find the perfect vehicle for their needs. Plus, customers may be eligible for 0% financing

up to 60 months†. Kings County Chrysler Dodge Jeep Ram is also offering Kingtastic top dollar for your trade, vehicle subject to inspection; less wear and tear.

Avrutsky explained, "We intend to move our new vehicle inventory by offering deals to local residents that could save them thousands off current market value pricing. This is an event that benefits everyone!" These never before seen savings are available only at Kings County Chrysler Dodge Jeep Ram. In addition to savings as much as 30% off dealer list price\* on new vehicles, Kings County Chrysler Dodge Jeep Ram will also have special deals on all certified pre-owned vehicles.

*"This is really an event for everyone," explains Avrutsky. "Kings County Chrysler Dodge Jeep Ram has vehicles that are as unique as each of our*

*customers. No matter what you're in the market for, we have it! This Spendless Summer Sales Event was made for you; you don't want to miss it!"*

Every type of credit worthiness will be accepted to obtain credit approval, even for those who may have had credit problems in the past. "In this economy," stressed Avrutsky, "almost everyone is having some type of credit issue. There's just no way that we're going to exclude them from this event."

Trades are also welcome at this event. Kings County Chrysler Dodge Jeep Ram will do whatever it can to ensure it offers more than market value whenever possible. Vehicle subject to inspection; less wear and tear. Kings County Chrysler Dodge Jeep Ram would like to remind customers that this event is a first-come, first-served event, so it's critical to come early for the best selection.

The Kingtastic Spendless Summer Sales Event will take place at Kings County Chrysler Dodge Jeep Ram at 2286 Flatbush Ave. in Brooklyn. Kings County Chrysler Dodge Jeep Ram will be open as early as 9:00AM.

For more information, call **866-899-7319** or visit **www.KingsChrysler.com**.



\*On select vehicles. †To qualified buyers on select vehicles. See dealer for details. Department of Consumer Affairs (DCA)# 1435478, Department of Motor Vehicles (DMV)# 7114167. Offers expire: 6/30/14.

# SPORTS

FOR MORE SPORTS, GO TO CARIBBEANLIFENEWS.COM/SPORTS



U.S. player Tim Chandler.

AP Photo/dapd/Timm Schamberger

## U.S. not ready for the World

By Patrick Horne

USA men's World Cup soccer manager Jurgen Klinsmann, like any coach, will live or die by his decisions and the prognosis isn't good. The German-born Klinsmann, in an attempt to create 'his' team, discarded proven World Cuppers and selected a very inexperienced squad to compete at the highest level of the game at the 2014 FIFA World Cup in Brazil, which started yesterday.

Klinsmann clearly favored players bred on German soccer despite their lack of

Continued on Page 44

## Caribbean Cup triple threat

By John Melbourne

Before the largest crowd of the young season New York Caribbean Cup soccer fans were treated to three outstanding soccer games this afternoon. At the end of the day Team St. Kitts and Nevis dominated Team Dominica 4-0, Team St. Lucia squeezed by Team Trinidad and Tobago 1-0 in a game that could have gone either way, and in the nightcap, the match of the day, Team Grenada's two early first half goals held up for a 2-1 win over Team Guyana.

**Team St. Kitts and Nevis wins**

From the opening, Team St. Kitts and Nevis played with more determination and organization as Team Dominica defend-

Continued on Page 44



# READY FOR THE FIGHT

Mikkel Lespierre (left) won against Raphael Luna by unanimous decision.

Photo by Amy Drury

## Mikkel Lespierre preps for July bout

By Robert Elkin

Mikkel Lespierre is anxiously awaiting for his next fight. All eyes from his friends, family and the average boxing buffs from here in the metropolitan area will be cheering him on and hoping he does well, maybe even win by a knock

out. He is training hard for his upcoming fight at Gleason's Gym. He wants to be in top shape when he demonstrates his skills in the ring. Now he must wait for his opponent to be announced. His trainer, Dan Saxby, has not made up his mind about his next opponent.

However, the bout has been set for Friday evening August 1 and the bout is part of the Elton D'Harry Promotions at the old Jamaica Arena as part of a boxing card. Lespierre, who wants to keep his unbeaten record in tact, expects to fight

Continued on Page 44



Trainer Don Saxby (left) with Mikkel Lespierre.

Photo by Amy Drury

# Good talent and skill for the sport

**Continued from page 43**  
in the junior welter weight class or 140 pound weight class.

Originally from Trinidad, Lespierre came to Brooklyn when he was six years of age.

He enters his sixth professional fight with a 5-0 record, including one draw and three knockouts. As an amateur, he had 55 bouts with a winning record.

Many people, including the opposition, and his connections, including the other pugilists who work with him, say that Lapierre's best punch is his uppercut.

"I favor my uppercut and use it a lot," he said at

Gleason's Gym in downtown Brooklyn where he works out. "An 'uppercut' is a hard throw to punch. I don't have problems throwing it and I can throw it from almost any angle. I've been working out at Gleason's Gym since 2001. I've experienced a lot of pros who come here to spar. Some of these guys I've had a pleasure of sparring with. It's been a great experience as I've learned a lot from them."

His first trainer was Mike Smith who has helped him with his uppercut.

"Smith developed my foundation," the 24-year-old pugilist added at Gleason's Gym. "He no longer trains

here, for he moved to Las Vegas. He established my foundation well enough for me to throw my punches in any direction or angle that I choose and is suitable for me."

His current trainer Don Saxby has been improving him ever since Smith left.

"Saxby has been with me for whole amateur career," Lespierre went on during a recent Saturday morning. "He's been able to see me grow, He became my head trainer in about 2009. (In fact,) he's my trainer and coach. He's been with me for four years."

Lespierre began his sports career at Brooklyn's

Transit Tech High School. During his schoolboy days, he became used to the sport of boxing.

"Doing it for so long I've been getting accustomed to it," said the Brooklyn resident who attended City Tech College for a brief time. "Boxing never kept me bored as I learned something new every day. I have good talent and good skill for the sport.

# Soccer World Cup

Continued from page 43

international experience. The Americans will take on Ghana on Monday, and Portugal (6/22) and Germany (6/26) in a tough Group G in preliminary play. Among the American players dropped was the USA's most successful World Cup player, all-time leading scorer Landon Donovan, who, had he been selected, would have come into this, his fourth tournament, with 59 international goals and the experience of over 120 international games. The USA World Cup team should be the country's strongest unit and indicative of the standard of game in the country. The team should be built and molded over a four-year period to develop strong team spirit and player bonding; the players eventually should exude an intense passion to play for the country and for each other. World Cup play requires this passion and intensity, awash with national pride, to be successful. Klinsmann World Cup squad seems devoid of these intangibles.

The World Cup is not the place for inexperienced players; Klinsmann should have built the squad around the many experienced players as possible to take the strongest team to the tournament; much work was done by previ-



In this May 22, 2014 file photo; U.S. soccer player Landon Donovan stretches prior to training for the World Cup soccer tournament in Stanford, Calif.

AP Photo/Ben Margot; File

ous national team coaches to develop a core group of veteran players, including former captain and defender Carlos Bocanegra; defensive midfielder Maurice Edu; forward Eddie Johnson, the leading scorer in the qualifiers; and central defender Clarence Goodson. These players all have World Cup experience and, except Bocanegra, qualified the team for Brazil and then were dropped. The excruciating part in all this is that the new players are not better than those discarded. Klinsmann chose the wrong time to breakdown and rebuild.

# New York Caribbean Cup

Continued from page 43

ed stoutly. For this game, Team Dominica showed up with a goalkeeper who helped keep the "Sugar Boyz" at bay for much of the first half, but at the 25th minute, Joeski Williams pounced on a loose ball inside the box and slid the ball home to put his team up 1-0. Five minutes later, kicking toward Egan Street, the referee put the ball on the spot after an infringement inside the box against Team Dominica. Donroy Liburd stepped up and made no mistake, Team St. Kitts/Nevis 2

Team Dominica 0.

Just before the end of the first half, Team St. Kitts/Nevis snared its third goal when Team Dominica's defense watched Yusuf Saunders rise above them and head home from a corner kick.

On resumption, it took the "Sugar Boyz" 15 minutes to widen the gap. Substitute Jamie McKoy ran on to a ball misplayed by Team Dominica's defense and between hesitation, indecision and luck, eventually bundled the ball into the net. McKoy actually had more opportunities to score that would have given Team

St. Kitts/Nevis a wider margin of victory but shooting is not something practiced on a Sunday as he missed a couple of good opportunities. At the whistle it was a well deserved 4-0 win for the twin-island.

## Team St. Lucia makes it Two from Two

After their win against Team Grenada on opening day, the game against Team St. Lucia was probably the measuring stick for Team Trinidad and Tobago as to their improvement in the New York Caribbean Cup Soccer Tournament.

## NYPD Traffic Enforcement Agents

Become a NYPD Traffic Enforcement Agent and serve your community in a unique and rewarding way. If you meet the following requirements, this promising career might be right for you:

<p><b>Requirements</b></p> <ul style="list-style-type: none"> <li>• Minimum 18 years of age at the time of appointment</li> <li>• Residency in the 5 boroughs of NYC (within 90 days of appointment)</li> <li>• High School Diploma or GED</li> </ul>	<p><b>Salary and Benefits</b></p> <ul style="list-style-type: none"> <li>• Earn over \$33,000 after 2 years</li> <li>• Enjoy generous pension, medical and dental plans</li> <li>• Paid vacation and sick leave</li> <li>• Uniform allowance and night differential</li> <li>• Excellent promotional opportunities</li> </ul>
---	---

**Call 212-Recruit or Chat with a recruiter on the website below.**

**For more information, visit**  
**NYPDCivilianJobs.com**

NYPD is an Equal Opportunity Employer

**\$0  
DOWN!**

**SCORE DAD  
A GREAT DEAL THIS SEASON!**

**SAVE  
BIG  
ON NISSANs  
& INFINITI's**



**HUGE CERTIFIED PRE-OWNED INVENTORY ALL MAKES! ALL MODELS!**



**2011 NISSAN ALTIMA S**  
BUY FOR **\$13,995**  
Stk #1387, 28,148 mi., 4 cyl, auto, air, full power, cd



**2014 NISSAN VERSA S**  
BUY FOR **\$13,995**  
Stk #1429, 884 mi. 4 cyl, auto, air, cd, cruise, tilt



**2007 INFINITI FX35 AWD**  
**BLUETOOTH**  
BUY FOR **\$13,995**  
Stk #U4732, 58,993 mi., 6 cyl, auto, air, nav, sunroof, leather, htd sts., cd, alloys



**2007 INFINITI QX56 AWD**  
BUY FOR **\$15,995**  
Stk #1449, 85,787 mi, V8, auto, air, navi, sunroof, leather, htd seats, alloys.



**2011 NISSAN SENTRA SPECIAL EDITION**  
BUY FOR **\$14,995**  
Stk #1425, 8603 mi., 4 cyl, auto, air, NAV, SUNROOF, BLUETOOTH, SPOILER, ALLOYS



**2011 NISSAN ROGUE S AWD**  
BUY FOR **\$14,995**  
Stk #1432, 7196 mi. 4 cyl, auto, air, full power, cd, cruise, tilt, folding sts

**7196 MILES**



**2011 INFINITI M37X AWD**  
BUY FOR **\$21,995**  
Stk #U4518, 79,041 mi., V6, auto, nav, lthr, moonroof, back up cam, Bluetooth, cd, alloys



**2010 INFINITI EX35 AWD**  
BUY FOR **\$22,995**  
Stk #U4709, 20,971 mi., V6, auto, air, sunroof, lthr, nav, Bluetooth, heated sts.



**2011 NISSAN ALTIMA SL**  
BUY FOR **\$16,995**  
Stk #1403, 31,064 mi., 4 cyl, auto, sunroof, leather, Bluetooth, htd sts.



**2011 NISSAN JUKE SL AWD**  
BUY FOR **\$16,995**  
Stk #1453, 27,133 mi., 4 cyl, auto, air, navi, sunroof, leather, htd seats, Bluetooth, back up camera.



**2010 INFINITI FX35 AWD**  
BUY FOR **\$22,995**  
Stk #U4717, 45,690 mi., V6, auto, air, nav, sunroof, lthr, htd/cooled sts., Bluetooth



**2011 INFINITI G37X AWD**  
BUY FOR **\$24,995**  
Stk #1404, 26,801 mi., V6, auto, Bluetooth, nav, leather, moonroof, back up cam



**2011 NISSAN MAXIMA S**  
BUY FOR **\$19,995**  
Stk #1434, 29,971 mi. V6, auto, air, sunroof, Bluetooth, back up sensors, cd



**2011 NISSAN MURANO SL AWD**  
BUY FOR **\$20,995**  
Stk #1381, 35,798 mi., V6, auto, air, cd, leather, back up cam, htd. seats, panoramic roof, Bluetooth.



**2011 INFINITI M35X AWD**  
BUY FOR **\$25,995**  
Stk #U4729, 41,491 mi., V6, auto, air, navi, sunroof, lthr htd & cooled sts, back up cam.



**2012 INFINITI G37X AWD**  
BUY FOR **\$28,995**  
Stk #1385, V6, auto, nav, moonroof, lthr, back up cam, Bluetooth, white, 13,477 mi.



**2011 NISSAN MAXIMA SV PREMIUM TECH**  
BUY FOR **\$22,995**  
Stk #1373, 30,970 mi., V6, auto, nav, leather, htd sts., Bluetooth, back up cam, panoroof, rear shade, music box

**LOADED**



**2011 NISSAN ARMADA AWD**  
BUY FOR **\$29,995**  
Stk #1456, 38,803 mi., V8, auto, air, navi, sunroof, leather, dvd, htd seats, Bluetooth.

**PLATINUM EDITION**



**2012 INFINITI FX35 AWD**  
BUY FOR **\$35,995**  
Stk #U4715, V6, auto, nav, moonroof, leather, back up cam, bluetooth, 16,099 mi.



**2011 INFINITI QX56 AWD**  
BUY FOR **\$38,995**  
Stk #U4718, 39,139 mi, V8, auto, air, nav, moonroof, leather, heated, Bluetooth



**2013 DODGE AVENGER SXT**  
BUY FOR **\$16,995**  
Stk #1473, 18,690 mi., 4 cyl, auto, air, NAVIGATION, LEATHER, HEATED & POWER SEATS, ALLOYS, CD, SPOILER



**2008 LEXUS IS250 AWD**  
BUY FOR **\$16,995**  
Stk #U4730, 40,996 mi., V6, auto, air, sunroof, leather, htd seats, cd, alloys.



**2010 BMW 328ix AWD**  
BUY FOR **\$17,995**  
Stk #U4716, 36,636 mi., 4 cyl, auto, air, nav, sunroof, leather, memory, heated sts., Bluetooth



**2013 MAZDA2 SPORT**  
BUY FOR **\$13,995**  
Stk #1390, 554 MI, 4 cyl, auto, air, full power, cd, folding seats



**2008 LINCOLN MKX AWD**  
BUY FOR **\$15,995**  
Stk #U2737, 45,797 mi., 6 cyl, auto, air, leather, alloys, htd sts., Bluetooth, cd

**LOW MILES**



**2012 HONDA PILOT EX-L RES AWD**  
BUY FOR **\$29,995**  
Stk #U4681, 32,017 mi. V6, auto, dvd, sunroof, lthr, htd, back up cam, 6 cd, bluetooth



**2013 LEXUS GX460 AWD**  
BUY FOR **\$46,995**  
Stk #1455, 10,528 mi, V8, auto, air, navi, DVD, sunroof, leather, Bluetooth.

**LIKE NEW**



**KINGS NISSAN**

2758 Coney Island Ave. Brooklyn, NY 11235

**888-485-4647**

**KingsNissan.com**

**KINGS INFINITI**

20 Neptune Avenue Brooklyn, NY 11235

**888-925-4647**

**KingsInfiniti.com**

# West Indies players lack aggressiveness

The first Test match between the West Indies and New Zealand started at Sabina Park in Jamaica with the tourists taking the advantage in first two days. New Zealand scored 508 runs for 7 wickets declared. Jim Needham scored 107 and Kane Williamson 121. New Zealand batsmen batted intelligently on a wicket where the ball was not coming on to the bat. They ensured that they took a good look at the pitch and the bowlers.

## WINDIES BOWLERS A LITTLE RUSTY

Sulieman Benn and fellow spinner Shane Shillingford were not at their best after a long layoff from Test cricket. Benn had disciplinary issues and Shillingford had to resolve his bowling action. Pacers Kemar Roach and Jerome Taylor were also out of circulation for a while. Several members of the team



## Eyes on Cricket

By George H. Whyte

suffered from injuries and other issues. All of the West Indies front line bowlers have been out of international action for a long period. Taylor was the best of the West Indies bowlers with one wicket for 37 runs with 110 overs going down as maidens.

## NEW ZEALAND 508 FOR 7 DECLARED

New Zealand dominated the first two days with Kane Williamson and Jimmy Neesham scoring centuries and Tom Latham and BJ Watling scoring in the 80's.

## WINDIES BOWLING STATISTICS

Jerome Taylor  
26-11-37-1  
Sulieman Benn  
52-14-142-3  
Shane Shillingford  
46.3-7-145-3

The West Indies team will have to do some hard work to make a come back and show some muscle in this three-Test series.

It is important that the West Indies bowlers regain their rhythm and pick up wickets much more frequently at an economical rate. Pacer Roach is expected to return to his full fitness and good rhythm in the second Test match. West Indies must play very aggressive cricket and stay focus throughout.



West Indies' Jerome Taylor, center, celebrates after New Zealand's opener Peter Fulton was caught behind by teammate Denesh Ramdin for 1 run during the opening day of their first cricket Test match in Kingston, Sunday, June 8, 2014.

AP Photo/Arnulfo Franco

Bay Ridge Nissan | 888.801.9107

FREE VALET PARKING

Happy Father's Day  
*You deserve it!*

# One Price...Our Best Price

The New Way To Buy A Car



No Games. No Hidden Fees. 72hr/ 300 mile Return Policy



It's Different Here 6501 5<sup>th</sup> Ave. Brooklyn, N.Y. 11220

Store Hours: Mon to Thurs: 9:00<sup>AM</sup> - 9:00<sup>PM</sup> | Fri: 9:00<sup>AM</sup> - 6:00<sup>PM</sup> | Sat: 9:00<sup>AM</sup> - 6:00<sup>PM</sup> | Sun: 12:00<sup>PM</sup> - 5:00<sup>PM</sup>

## Pre-Owned Inventory

1 Year FREE Maintenance



Auto Check



All Makes & Models





MCU PARK

BROUGHT TO YOU BY MUNICIPAL CREDIT UNION

# CYCLONES CONFIDENTIAL

## Cyclones are headed back to Coney

Brooklyn's Boys of Summer return to battle hated Staten Island Yankees Saturday night

By Brooke Cortese

The latest Battle of the Boroughs will kick off this year's Brooklyn Cyclones season, as the mini-Mets take on the Evil Empire of the New York-Penn League, the hated Staten Island Yankees in a four-game set — and the first pitch on Opening Night at MCU Park will be Saturday at 6 pm.

Sitting in the front car for the Clones this season will be new manager Tom Gamboa, who says he's ready for the wild ride that can only take place in Coney Island after taking two years off from baseball.

"It has definitely reenergized me to be around young people," said Gamboa, 66, who has done time in the Cubs and Royals organizations, and is best known for his on-field run-in with thugs who attacked him while he was coaching first base for the Kansas City Royals in 2002. "I'm just trying to pass on my

experience to help the players."

The names of those players had not been finalized before we went to press, but the team is expected to include highly touted Dominican shortstop Amed Rosario, a five-tool player whom Gamboa compared to Dodger superstar shortstop Hanley Ramirez.

"He can literally do everything — steal bases, hit balls out of the ballpark — he's just a force to be reckoned with," Gamboa said.

If he gets the call, Rosario would become the youngest player to ever don a Cyclones uniform on Opening Night.

Another player that could be ticketed for the team is first-round pick and Team USA alum Michael Conforto, the Oregon State left fielder who smacked 31 homers and drove in 179 runs in 182 games during his three years with the Beavers.

The Cyclones hope to



**HEAVY HITTER:** First-round pick Mike Conforto swung a big bat for the Oregon State Beavers, and could add some punch to what was a punchless Cyclones lineup.

Associated Press

improve upon what could only be considered a dismal season last year when the team's anemic offense — a .235 average and only

one player with at least five home runs — led to a 38-37 record that wasn't good enough to get them into the playoffs.

Hopefully, players with big bats like Conforto's will solve that problem, say the team's fans.

"Clearly, if the Clones

hope to go anywhere this year, they are going to have to hit better," said Sylvan Migdal, who monitors the Cyclones' progress each season from in the stand and at his desk at the Community Newspaper Group. "Players of Conforto's caliber would be fun to watch, and would give us a better chance to pick up some Ws."

Of course, heading out to the ballpark isn't just about beating the Yankees.

Cyclones fans can expect exciting new promotional games, including the highly anticipated "Seinfeld Night" on July 5, which commemorates the 25th anniversary of the first episode of the beloved sitcom. The buzz surrounding Seinfeld Night has gained the Cyclones national attention, and fans who show up will receive a Keith Hernandez bobblehead to give to fans while they enjoy nine innings worth of "Seinfeld"-inspired antics.

# THINGS ARE LOOKING UP

...with an MCU Auto Loan

FIXED RATES AS LOW AS

# 1.95%

APR\*

**MCU** Strong Trusted Growing  
MUNICIPAL CREDIT UNION

1-888-4MCU-AUTO  
nymcu.org

\* APR = Annual Percentage Rate. These rates are available to well-qualified borrowers when payroll deduction or direct deposit is selected as the method of repayment. Some applicants will qualify at higher rates as determined by creditworthiness. For model years 2014-2013, your payments will consist of 60 monthly payments of \$17.51 on each \$1,000 borrowed at 1.95% APR. For model year 2012, your payments will consist of 60 monthly payments of \$17.60 on each \$1,000 borrowed at 2.25% APR. Some restrictions apply. Rates will increase after closing if you stop paying your loan by automatic payroll deduction or direct deposit. Rates subject to change without notice. Competitive rates available for older models and refinances. Membership required.

# CROSSWORD BY STATEPOINT MEDIA, INC.

THEME: FAMILY MOVIES

**ACROSS**

1. Move smoothly
6. \*What Horton heard (2008)
9. \*Lost clownfish (2003)
13. Kind of sentence
14. Reporter's question
15. Become established
16. Bring upon oneself
17. Long fish
18. Past or present
19. \*Sherman's dad (2014)
21. Swelling, pl.
23. "\_\_\_ bad!"
24. At the summit of
25. Overall part
28. Pressure unit named after Torricelli
30. \*"The \_\_\_\_\_," squirrel's adventure (2014)
35. \*Sandler of "Big Daddy" (1999)
37. Nabisco cracker
39. One of excessive propriety
40. \_\_\_ Verde National Park
41. \*"Flushed Away" underworld (2006)
43. Icelandic epic
44. Pesto ingredient
46. Piercing spot
47. They're often hidden
48. Chemical cousin

50. Frill around collar
52. Public hanging?
53. Data holder
55. Aggravate
57. \*"How to Train Your \_\_\_\_\_" (2010)
60. Lured with a decoy
64. Canine foe
65. Freudian topic
67. Former Belgian Congo
68. Ahead in years
69. Go wrong
70. Spritlike
71. Not guilty, e.g.
72. Hard to escape routine
73. Nathaniels, familiarly

**DOWN**

1. On a golf club
2. Crescent
3. Ancient Peruvian
4. Skeptic's MO
5. Drill into brain
6. Little Miss Muffet's meal ingredient
7. Garden cultivator
8. Baby owl
9. Indian Lilac tree
10. Europe's highest volcano
11. \*Piggy's title
12. Single
15. Work promotion
20. "The \_\_\_\_\_," classic rock

- band
22. Knotts or McLean
24. MoMa's display
25. \*Orphaned after forest fire (1942)
26. Content of cognition, pl.
27. \_\_\_\_\_ profundo
29. Cambodian currency
31. Not kosher
32. Succeeded kingdom of Judah
33. More eccentric
34. \*Beauty's true love (1991)
36. Cripple
38. Domesticated ox having humped back
42. Fit out again
45. Accounting journal
49. \*A story of Blu (2011)
51. \*It featured the hit song "Let it Go" (2013)
54. Curl one's lip
56. Aussie bear
57. \*Raggedy Ann is one
58. Boorish
59. Away from port
60. Database command
61. Pick-me-up
62. Buffalo's lake
63. Hibernation stations
64. Chop off
66. \*He was despicable (2010)

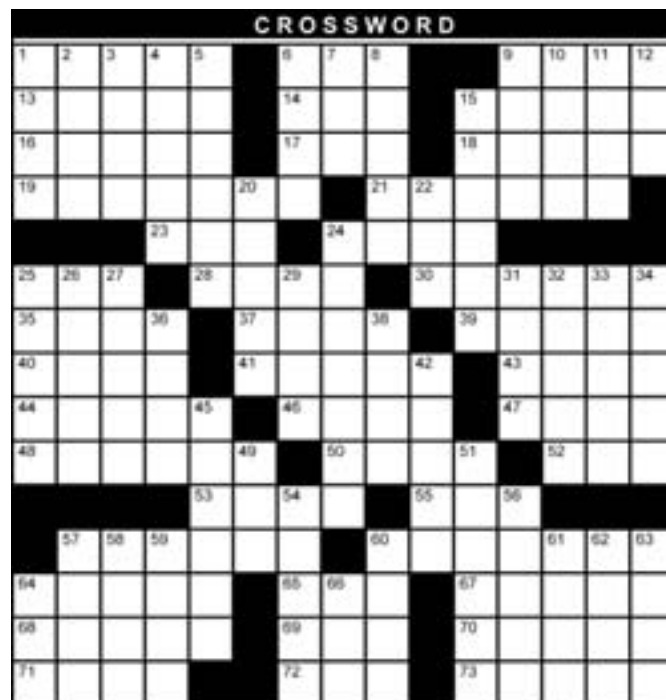

**dish**  
 Make the Switch to Dish Today and Save Up To 50%  
 Call Now and Ask How! **1-800-318-5121**  
 Call 7 days a week 8am - 11pm EST Promo Code: MB0111

Promotional Packages starting at only **\$19.99** mo. for 12 months

**FREE** PREMIUM MOVIE CHANNELS\* For 3 months  
 HBO, SHOWTIME, STARZ

**Answers in Classified Section**

**Summer Sale!**

To **TRINIDAD**  
 Travel Every Friday from June 27- September 05

Starting from **253 558**  
 one-way round trip

To **GUYANA**  
 Non-Stop Every Tue - Thu - Sat - Sun

Starting from **285 499**  
 one-way round trip

**Celebrating 19 Years**

All Taxes Included **LIMITED SEATS**  
 Rates Subject to availability, and can change Without Notice  
 Must be purchased at time of reservations  
 Change / Cancel Fees Apply - Black Out Dates Apply

Book On-Line **TRAVELSPAN.COM** Call: **718-845-0437**

121-24 LIBERTY AVE. RICHMOND HILL, NY 10475    1176 NORTHRAND AVE. BROOKLYN, NY 11234    34 REGENT STREET LONDON, U.K.    110 CENTRE HALL, COVINGTON, MD    CAPITAL PLZ 012, FREDERICK, MD

WALFORD SHOPPING PL. WOLFSPR    THE MALL WITH ENGLISH & HIGH STREET SAN FERNANDO    CHARTER PARTICIPANT AGREEMENT REQUIRED FOR FLIGHTS OPERATED BY VISION AIRLINES

**Your Trusted Parenting Magazine!**

**Get Your Copy Today!**

At your local library or other specialized locations throughout Queens, Brooklyn and the Bronx.

**Check us out at [www.NYParenting.com](http://www.NYParenting.com)**

For distribution information, please call us at (718) 260-4554



# Foster Care

Foster care -  
Change a lifetime



## FATHERS WANTED

Help a child celebrate Father's Day!  
Become a Foster or Adoptive Parent.

EAST HARLEM COMMUNITY PARTNERSHIP PROGRAM  
call: 646-672-5220 or email: EHCPP.CD11@gmail.com

### Partner Agencies

Catholic Guardian Services | Children's Village | Children's Aid Society | Edwin Gould Services for Children and Families | New York Council on Adoptable Children  
New Alternatives for Children | New York Foundling | You Gotta Believe | Spence-Chapin Services to Families and Children

### OPEN UP YOUR HEART AND HOME TO A CHILD



### BECOME A THERAPEUTIC FOSTER PARENT

Help A Child or Teenager In Our Community

Please Contact: 888-819-4647 x2127  
**Corrine Bethune**  
1668 Pitkin Avenue, Bklyn, NY 11212  
50 Bay St. Staten Island, NY 10301



### Make a Difference, Become a Foster Parent!

Bronx and Harlem Youth need loving and  
compassionate homes.

#### We Provide:

Ongoing FREE training and financial assistance.  
24 Hour Professional Support.

We are looking for homes for Teens, Sibling Groups,  
LGBTQ Youth, and Pregnant and Parenting Teens

**718-561-4340**  
Ext. 115

### MAKE a DIFFERENCE in a CHILD'S LIFE

Open your hearts and home to  
a child/teen in need

Benefits to Our Families Include:

- FREE Intense Training
- Generous Stipends
- 24 hour on-call staff  
and much more!!



For information contact Recruiter/Trainers:

**Carmella @ 718-297-5074 ext 24**

**Tanya @ 718-363-3521**

Extraordinary reach. Unconditional care.



## SAVE MONEY



BY SHOPPING  
IN OUR  
CLASSIFIEDS

## Caribbean Life

## YOUR WEEKLY HOROSCOPE FOR JUNE 16TH TO JUNE 22ND

### ♈ ARIES: Mar 21/Apr 20

Aries, let your creative side take over this week. Your imagination is ready to run wild, and this burst of creative energy will have long-lasting positive effects.

### ♉ TAURUS: Apr 21/May 21

Taurus, though you are known for being a tad stubborn, this week you are open to any and all suggestions. You may surprise a few people by being so open-minded.

### ♊ GEMINI: May 22/Jun 21

Gemini, while you may have natural leadership abilities, most of the time you do not want to pull rank. This week you may need to step things up a bit.

### ♋ CANCER: Jun 22/Jul 22

Cancer, now is a good time to travel, even if it means just a quick jaunt. But if a big vacation is on the horizon, know that you will likely have a smooth trip ahead.

### ♌ LEO: Jul 23/Aug 21

Your powers are magnetic this week, Leo. Others find you simply irresistible, which can bode well if you are looking for a romantic partner or want to step things up.

### ♍ VIRGO: Aug 24/Sept 22

Virgo, a busy week at work will require lots of cooperation among you and your coworkers. If ever there was a time to summon your leadership abilities, now is the time.

### ♎ LIBRA: Sept 23/Oct 23

Libra, many things are in disarray and you may need some help getting back to efficient living. Download an app to help you track expenses or keep tabs on your responsibilities.

### ♏ SCORPIO: Oct 24/Nov 22

You are bound to be the center of attention, Scorpio. Get over any shyness early on because you will be spending time with coworkers for most of the week.

### ♐ SAGITTARIUS: Nov 23/Dec 21

You will do some of your best work at home this week, Sagittarius. Spend ample time getting the house in order. A few days working from home could kickstart plans.

### ♑ CAPRICORN: Dec 22/Jan 20

Capricorn, quickly curb any feelings of boredom by exploring a new hobby. Try taking a new fitness or art class. You'll have chances to mingle, too.

### ♒ AQUARIUS: Jan 21/Feb 18

Put the brakes on impulse buys, Aquarius. This week you may be tempted to spend more money than you have, and that will only lead to long-term financial concerns.

### ♓ PISCES: Feb 19/Mar 20

Pisces, it is time to rebrand yourself. This may start with a mini-makeover or more significant changes to your life and career.

**ASHLEY**  
Spiritual Reader  
God gifted to help you in  
all problems of life.  
Reunite loved ones.  
Guaranteed results.  
229-805-3866  
Queens Loc on Hillside  
Near F Train 1 Free Ques

Love & Relationship  
Specialist  
Readings by Lucy  
24 hour results  
reuniting lovers  
www.psychiclucy.net  
323-314-5809

**MOTHER DORINA**  
Results in 24 Hours  
Are you facing difficult  
problems? Health,  
unhappiness, drinking  
or afraid in any way?  
1907 Inverness Blvd  
Austin, TX 78745  
512-804-0855

Psychic Consultant  
Bold Solutions-Brilliant  
Results! Gifted Love Special-  
ist. Reunites lovers. Rela-  
tionship Repair. Restores  
happiness. Clears nega-  
tivity. Stop Wondering! Call  
Today. Free Question.  
1-713-870-5109

Psychic Readings  
by Ann  
Over 35 yrs exp. Will  
bring back loved ones.  
I have helped 100's of  
people. One Question Free  
Know the answers now.  
Call 954-643-6335

**REVEREND LEWIS**  
SPIRITUAL HEALER  
Solves All Problems  
Reunites Lost Love,  
Heals unnatural Sickness  
& Removes Bad Luck.  
FREE READING  
(912) 877-4828  
PO BOX 1121,  
HINESVILLE, GA 31310

**SPIRITUAL  
ADVISOR**  
One visit could change  
your LIFE and restore  
what was lost.  
One FREE question!  
Call 917-669-5222  
lifecoachmaria.com

Spiritual Healings  
By Dorothy Brandy  
Gifted Reader & Advisor  
Helps every problem  
Removes bad energy  
954-909-3020  
spiritual\_dorothy@live.com

**SERIGNE**  
Spiritual Reader & Coach  
Helps bring back loved ones.  
Reunite lovers, issues, court cases, success in business, remove bad luck, black magic & witchcraft. Stop enemy & offer protection!  
**FAST RESULTS!**  
917-679-1518  
www.spiritualrestore.com

**CHRISTIAN READER**  
Bishop Phil



**Call Now!**  
FREE READINGS BY PHONE  
1-866-915-4804  
ChristianPsychicMinister.com

**INTERNATIONAL CLAIRVOYANCE & SPIRITUAL HEALER**  
Pure and powerful gift from God with a world wide reputation.



I can help you with your relationship problems, court cases and bad luck. As well as your concerns regarding depression, substance abuse, marriage, exams, business & many more.  
Results in a few days guaranteed.  
**CALL MALIK 917-328-8537**

**READER/ADVISOR**  
**PROFESSOR HAKEEM**  
INTERNATIONAL SPIRITUAL HEALER & CLAIRVOYANT & PSYCHIC.  
30 Years Experience from a Renowned Family with a very good Reputation of helping people all over the world. I strongly believe I can help & solve your problems in the quickest way even if you have been let down by other people. Are you suffering from Influence, Blockage, Unknown Disease, Unhappy Situation, Sexual Problems, Bad Luck, Business matters, Black Magic, Exams, Court Cases, Relationship problems. Do not hesitate to contact Professor Hakeem. Results within 7 Nights  
Call **917.353.3006** or **646.766.0779**  
**Your Pain is my responsibility.**

**Hougan Maxime**  
Spiritual Advisor  
Haitian Voodoo Priest  
Solves Your Problems  
Helps with Family Problems, Jobs, Immigration & Legal  
Reunites Loved Ones • Saves Your Marriage  
Brings Good Luck • Improves Business and More...  
**718-826-2553 or 917-622-7607**



**SISTER DUBONG**  
Call Now!  
Results Immediate  
Get Help Now!  
347-461-9190  
Listen:kingandqueenradio.com

Worried? Confused?  
~ Miss Gabby ~  
Psychic Love Specialist  
Solves difficult problems Reunites lovers! Returns happiness. Removes obstacles / negativity. FREE SAMPLE READING Call Today! 1-214-400-2653

**HEALER & ASTROLOGER**  
**PRIEST: RAM TULASI**



If you have a problem that has not been solved by any Pandith, Astrologer or Spiritualist. Priest invites you to contact him as a last resort & he promises that all your problems will be solved.

**EXPERT IN FINDING SOLUTIONS FOR MONEY PROBLEMS & REMOVE BLACK MAGIC BY USING INDIAN HERBS, ROOTS, SOIL TANTRAS, MANTRAS, YANTRAS & LAXMI DEVI POOJAS.**  
**PRIVATE & CONFIDENTIAL**  
MEET WITH PRIEST ONCE, START CHANGING YOUR LIFE **516-262-8970**  
110-18 Liberty Ave., Richmond Hill, NY 11419  
Inside Ghazal Beauty Parlor (Boutique) **100% RESULT GUARANTEED**



**SPIRITUAL HEALER & ASTROLOGER**  
**PANDITH: RADHA KRISHNA (I.C.A.S)**

Pass Down from Generation  
Pandith is an Expert in Palm Reading, Horoscopes, Face Reading, Patra Reading  
Expert in Finding & Removing any kind problems of Black Magic, Obiya, Evil Spirits, Voodoo, Bad Luck, Curse & All Evils.  
For Private & Confidential Appointment  
Open 7 Days: 10 AM to 8 PM  
**Tel: 646-496-3107**  
118-01 Liberty Ave.  
Richmond Hill, NY 11419  
(Inside Neena Boutique & Prvt Office)  
**Radhakrishna5505@gmail.com**

**ASTROLOGER & PALM READER**  
Unique Form of India's Astrology & Spirituality  
**INDIAN PANDITH: DEV DAS**



Removal of Any Kind of Problems:  
Black Magic, Obeah, Evil Spirits, Voodoo, Bad Luck, Curse & All Evils.  
**OVERCOME ALL YOUR STRESS & STRAIN**

- Business Problems • Children • Education • Job
- Health • Wealth • Love Marriage • Husband & Wife Problems • Family Matters • Court Cases • Drinking Problem • Depression • Sexual Problem • Success in Life • Immigration • Other Personal Problems

**1 FREE QUESTION**  
**PANDIT READS OPEN BOOK**  
**Tel: 646-258-1425**  
104-42 Lefferts Blvd. Richmond Hill 11419  
(Located in Private House)

**READER AND ADVISOR**  
**Mister KHALIFA**  
International African Spiritual Healer & Clairvoyant  
WITH 39 years Exp. Helping people across the world: Africa, USA, France, Australia, UK etc...  
Solves all Problems in the Quickest Way:  
Bad Influence, Blockage, Unknown Disease, Unhappy Situations, Sexual Problems, Bad Luck, Business Success, Black Magic, Exams, Court Cases, Unhappy Marriage & Relationship.  
Do not hesitate to call Mr Khalifa, Results within 7 nights.  
**646.339.2385 or 646.630.8303**

Yes, he's back from the shadow of death, the Jamaican born Obeah man and spiritual case worker.  
**MR. B**  
**CALL 718-523-1426**  
Guaranteed success where others fail.  
Power to help in all walks of life. Calls your friends and enemies by name, without asking you a single word. A visit to this Obeah worker from Jamaica will be of immense value to you.

**AFRICAN PSYCHIC/SPIRITUAL READER, HEALER & CLAIRVOYANT**  
WITH SPIRITUAL POWERS OF HIS ANCESTRAL MASTER'S SPIRIT. MR. LAMINE is Internationally known & will help with all problems in life.  
He has helped many celebrities. He can clear negativity, foresee future life events, solves impossible problems. Help bring back loved ones, family problems, depression, substance abuse, impotency/infertility, break black magic, jinx, demonic forces, success in business, exams, career, job & marriage.  
African powder for men to satisfy your wife.  
Never Gives Failing Advice • Your Pain Is My Responsibility  
**www.tatajabbie.com**  
**347-539-2163**

**Readings**  
by **TERESA MARIE**  
SHE SAYS:  
**DON'T GIVE UP!**  
GUARANTEED RESULTS IN 24 HOURS  
THIS SOUTHERN BORN Spiritualist, BRINGS YOU the solutions to the mysteries of the DEEP SOUTH. Helps thousands who have been CROSSED, HAVE SPELLS, CAN'T HOLD MONEY, WANT LUCK, WANT THEIR LOVED ONES BACK, STOPS NATURE PROBLEMS. GAIN FINANCIAL AID or PEACE, LOVE and PROSPERITY in the home today! SHE TELLS YOU ALL BEFORE YOU UTTER A WORD. ARE YOU SUFFERING FROM ILLNESS OR DISEASE that YOU CANNOT CURE? There is a doctor of all doctors. This doctor is GOD. THOUSANDS OF PEOPLE are amazed at the results gotten by TERESA. WHEN YOUR CASE SEEMS HOPELESS, THERE IS A REMEDY FOR YOU. If others fail you she won't.  
DON'T LET TIME OR DISTANCE KEEP YOU AWAY - THIS WOMAN DOES WHAT OTHERS CLAIM TO DO!!  
**TEL. 718-459-3412**  
OPEN 7 A.M. TIL 10 P.M. 7 DAYS A WEEK  
97-19 63RD DRIVE  
REGO PARK, NY

**\*\*\*\*MISS\*\*\*\***  
**RASTAFARI**  
Sent by God to help. Helping in Love, Family, removing Bad luck, Business, blocking enemies.  
Call for a free reading.  
**GUARANTEED**  
**\*\*\*RESULTS\*\*\***  
704-974-2502

**PSYCHIC JANET**  
Palm & tarot card readings. Helps in all matters of life. Love, help, happiness, & reuniting loved ones. Deals with karma, spells & dreams. If you a prefer a 4female psychic call **JANET.**  
720-231-2419  
If you prefer a male  
Call Nicholas  
303-522-2296

**AFRICAN ADVISOR & SPIRITUALIST**  
MR SHEIKH SALEEM, 6<sup>TH</sup> GENERATION OF AFRICAN MEDIUM, CAN HELP YOU OUT OF DESPAIR, SOLVES ALL ISSUES.  
Love specialist, Reunite lovers even hopeless cases, Business success, Release from spell, Clear Negativity, Strong Voodoo, Black Magic, Court issues, Family problems, Drugs, Careers, Exams, Gambling, Luck, Protection, Impotency/Sexual Powder & more.  
One visit will convince you • Quick Results  
By Appt Only • French & English speaking  
**917-254-6647 • 116TH/7TH AVE**  
**WWW.AFRICANMEDIUM.COM**



**LOCAL RESTAURANT DISCOUNTS**  
**SAVE \$\$**  
**DOWNLOAD LELOCA.**



SCAN THE QR CODES TO DOWNLOAD THE LELOCA APP FOR FREE.



**CALL 718-260-2555 TO ADVERTISE HERE**

**SPIRITUAL HEALER & ASTROLOGER**  
**PANDIT: BABA NARENDRA**



**HOPE IS LIFE**  
 IF YOU HAVE TROUBLES,  
 I HAVE SOLUTIONS

*Know your Past, Present & Future. All Religions are Welcome.*

**100% Removal of Black Magic, Bad Luck, Evil Spirits & Gives Holy Spirits & Give Holy Spirit Protection**

LOVE • FAMILY • CHILDREN PROBLEM • HEALTH  
 JOB • MONEY • LUCK • BIRTH • STONES • ENEMY  
 DEPRESSION • SEXUAL PROBLEM • COURT CASES

**SPECIALIZED IN BRINGING LOVED ONES BACK**

**PRIVATE & CONFIDENTIAL | 100% GUARANTEED RESULT**

**646-821-1765**  
 124-18 LIBERTY AVE, RICHMOND HILL, NY 11419  
 (Inside Guyana Gold)

**SRI KALI MATHA ASTROLOGER**  
**PANDITH MAHINDRA GURUJI**  
 35 YEARS OF EXPERIENCE  
**GOOD HELP - ASTROLOGY CENTER**



All Religions are welcome!

**PANDITH CAN PERFORM ALL TYPES OF POOJAS**  
 LAXMI POOJA, GRAHA POOJA, HOUSE PROTECTION  
 Visit once and get rid of your worries, Past, Present & Future, Face Reading, Hand Reading, Patra Reading, Open book reading.

**Specializes in getting rid of Black Magic, Generation Curses, Black Magic, Jadoo, Obiya, Witchcraft, Voodoo, All types of Evil Spirits etc.**

**Are you suffering from any of these Following Problems?**

-Black Magic	-Business	-Drinking Problems
-Evil Spirits	-Work Problems	-Health Protection
-Bad Luck	-Financial Problems	-House Protection
-Reunite Lovers	-Wife & Husband Pro	-Childless COUPLES
-Stop Divorce	-Children Mistakes	-Sexual Problems
-Depression	-Court Cases	-Lottery
-Psychological	-Mortgage	-Success in Life

**100% GUARANTEE**

PRIVATE & CONFIDENTIAL **347-833-3915** OPEN 7 DAYS  
 118-15 LIBERTY AVE RICHMOND HILL NY 11419 | Next to McDonalds (Private House)

**UNIQUE SPIRITUALIST & ASTROLOGER**  
**Indian Pandit: Vikram Raj**



**SUGGESTIONS & SOLUTIONS ON:**  
 Family, children, job, business, money, sickness, love, marriage, depression, jealousy, sexuality, immigration and all personal matter.

**QUICK RESULTS • 100% GUARANTEE**

**EXPERT IN PALM READING, DATE OF BIRTH, FACE READING & HOROSCOPE**

**REMOVES BLACK MAGIC, OBEAH, EVIL SPIRITS, VODOO, BAD LUCK, CURSE & ALL EVILS**

**Call: 347-502-9697**  
 121-10 Liberty Ave. Richmond Hill, NY 11419  
 (Inside Sandy's prvt office)

# Caribbean community classifieds

To Advertise Call: 718-260-2555

**► EMPLOYMENT** **To Place Your Ad Call 718-260-2555**

**► EMPLOYMENT SERVICES**

**ALL HOUSEKEEPERS**



**TAMI'S AGENCY**  
 International Housekeepers

Nannies, Housekeepers, Companions  
 Live-in/Live-out Full time/Part time

**We have jobs!**  
**Fast Placement!**

Brooklyn • Manhattan • Queens  
 Bronx • Nassau

**718-520-1313**  
**516-945-9520**

109-17 72nd Rd, Ste 2F, Forest Hills NY  
 Directions: E/F train to 71st Ave/Continental Ave  
 DCA License #1109974

**www.TamisAgency.com**

**► EMPLOYMENT SERVICES**

**► EMPLOYMENT SERVICES**

**ABLE HEALTH CARE**

**HOME HEALTH AIDES!**

**EARN UP TO \$34,000/YEAR**  
**FREE Training Classes**  
 Classes Start June 16 in White Plains  
 June 23 in Hempstead &  
 Call for other areas

**NEW HIGHER PAY RATES**  
 Staff Aide with Car Needed in All Areas  
 Full Time or Part Time  
 All Shifts - All Locations  
 Health Insurance  
 Vacation, Sick, Personal Pay  
**Higher Pay (up to \$13.00/hour)**



Immediate work & bonus for HHA's with certificates

Bronx/Westchester 914-470-9927  
 Brooklyn 718-947-3691 Queens 718-947-3671  
 Nassau 516-634-2115 Suffolk 631-729-2383

**www.ablehealthcare.com**

**► EMPLOYMENT SERVICES**

**► MEDICAL HELP WANTED**

**All Metro HEALTH CARE**

**LIVE-INS AND HOURLY AIDES**

For Immediate Placement  
 Elderly patients seeking (PCA, HHA, HA) aides to provide home care.  
 Excellent starting salary, vacation and benefits.  
 Spanish speaking a plus.

**For info, call All Metro Health Care at 718-327-2290 ext 190**  
 Email: info@all-metro.com

**► MEDICAL HELP WANTED**

**Carelink, Inc. Home Care Agency**  
 Lic. by NYC D.O.H.

**Hiring Experienced Certified HHA's**

**For All 5 Boros & Nassau Area**  
 Immediate Hire + Bonus for HHA's w/ Cars  
 • Health Insurance Available  
 • 3 Months Home Care Experience a Must

**Call For Appointment**  
**Mon-Fri 10AM-4PM**  
 718-488-8300 or 516-358-1999  
 Or email: Carelink1@hotmail.com

**► MEDICAL HELP WANTED**

**A Licensed Home Care Agency Looking for Certified HHA's/PCA's**  
 Must be available to work at least 3 day shifts per week

- Bx, Bklyn, Queens, NYC, SI, Nassau
- Weekends
- On-call • Live-in's
- Weekly Salary
- Direct Deposit
- Pre Taxed Metro Cards
- Refer-A-Friend Bonus
- Special Need for Spanish, Polish, Hungarian & Hindu Speaking HHAs/PCAs



**WHITE GLOVE COMMUNITY CARE, INC.**  
 Call Human Resources  
**718-387-8181 ext. 204**

**Call 718-260-2555 To Advertise Here**

# ► EMPLOYMENT

## To Place Your Ad Call 718-260-2555

### ► MEDICAL HELP WANTED

#### Certified HHAs or PCAs

Help us make a difference!



QNS, BKLYN, MANHATTAN, THE BRONX & NASSAU

**MANY CASES AVAILABLE...  
IMMEDIATE WORK... TOP \$\$\$**

**\$250 Sign-On BONUS** Live-ins only

- Starting at \$10.00/hour\*
- \$12.00/hr for Overtime
- \$130.00 Live-In Cases\*
- Health Benefits • Wellness Plan
- Free Gift Upon Application

946 McDonald Ave, Bklyn • Ph: 718-972-2929  
100-15 Queens Blvd., Forest Hills • Ph: 718-819-3131  
391 E. 149th St., Ste 314, Bronx • Ph 718-506-1006



### Certified Home Health Aides/ Personal Care Aides

F/T or P/T positions available,  
in all 5 boros & Nassau County.

**EXCELLENT PAY IMMEDIATE HIRE**  
Please Call Mon-Fri, 9AM-5PM

**BEVERLY'S  
HOME HEALTH CARE, INC**  
718-459-5592

### ► MEDICAL HELP WANTED

### ► MEDICAL HELP WANTED

## PCAs, HHAs, CNAs NEEDED!

**WE ARE HIRING:**

- Personal Care Aides (PCAs) • Home Health Aides (HHAs)
- Cert Nursing Assistants (CNAs)
- 2 years experience, Valid INS Work Authorization, 2 professional references needed.
- Must pass FBI fingerprint check
- Shifts: Daytime, Overnight, 24 hour livein
- Live-ins (\$143/ day), Live-out (\$11 per hour)
- Paid Vacation and Training

**212-726-2549**

Family Home Health Care, Inc.  
65 South Broadway  
Tarrytown, NY 10591

**CERTIFIED HHAs/PCAs**  
Immediate work available in Bronx/Westchester County.  
Hourly (Mon-Fri) and Live-in cases available.  
Car is a plus! Bilingual/Spanish encouraged to apply.  
Competitive Pay, Health Insurance and 401K offered.

**HHA TRAINING PROGRAM** starting soon! 3 wks training, free of charge & guaranteed job placement.

Call Ashley or Debbie at **914-631-0932** for more info.

### ► MEDICAL HELP WANTED

### ► MEDICAL HELP WANTED

## HHAs, PCAs & CNAs LIVE-IN ONLY

- Located North of NYC
- Competitive Wages
- Paid Travel & Vacation
- Monthly Bonuses
- Health Benefits Available • 401K

**Family Owned Business.  
Come Meet Our Staff**

Call for Info  
**800-505-6165**



### ► MEDICAL HELP WANTED

### ► MEDICAL HELP WANTED

## XINCON HOME HEALTH CARE

**HIRING CERT. HHA/PCA  
IMMED JOBS IN 5 BOROS.**  
SIGN UP BONUS, REFERRAL BONUS  
& TRANSIT BENEFIT  
FREE HHA TRAINING



224 W. 35TH ST, #708, NEW YORK  
**CALL FOR AN INTERVIEW  
MON-FRI, 8:30 AM - 5:00 PM**  
**212-560-0615**



**Make Your Choice Easy  
- With City Choice**

**"We Have Jobs In All 5 NYC Boroughs  
& Westchester. Hiring Right Now!"**  
For Home Health Aides (HHA's)  
Bilingual Spanish, Russian and Hungarian A+  
Medical Benefits Available!

2709 Coney Island Ave. 2nd Fl. Brooklyn, NY 11235  
T: 718-645-1116 F: 718-645-1307

6860 Austin St., Suite 302C Forest Hills, NY 11375  
T: 347-233-2626 F: 866-645-4876



## HHAs HOURLY & LIVE IN ASSIGNMENTS IMMEDIATE PLACEMENT

Call Today for  
An Interview Tomorrow  
**212-505-3640**

*The Right Person  
Makes All The Difference*



### ► MEDICAL HELP WANTED



## HIRING HHA'S

**GREAT PAY, GREAT HOURS  
GREAT BENEFITS!**  
(718) 257-0702

*Hablamos Español Nous Parlons Français!*  
**COME VISIT US AT (2) GREAT LOCATIONS:**  
545 Broadway, 3rd Flr, Brooklyn NY 11206  
2501 Grand Concourse, 3rd Flr, Bronx NY 10468

## Live-in Caregivers Needed IMMEDIATE PLACEMENT!

Live-ins for our Connecticut clients  
Excellent Pay & Benefits  
Experience required.  
CNA/HHA  
Driver's lic a plus  
Call M-F, 9am-4pm  
Toll FREE!  
**877-447-2990**

## Live-Ins Needed

Non-medical home care agency  
seeks experienced caregivers

All jobs are on Staten Island  
References & eligibility to  
work in US is a must.  
Car & certification a plus!

**To inquire call:  
718-477-1266**

**HOME HEALTH AIDES  
IMMEDIATE WORK**  
for HHA's with Certificates  
+ **SIGN-ON BONUS\***  
Call for schedule of  
**FREE Training Classes**  
F/T or P/T Jobs, All Shifts/Locations!  
**HIGHER PAY & NO DUES**  
Vacation, Sick Pay, Bonus  
\*for qualified candidates

able health care

Bklyn/Queens 718-947-3682  
Nassau/Suffolk 516-634-2109  
Bronx/Westchstr 914-470-9924

## ► SECURITY HELP WANTED

**SECURITY GUARDS WANTED**  
Must have NYS Security Guard License + 8 & 16 Hour Certificates, NYS ID & Social Security card. Fire Guards Also Needed. Must Wear Business Attire.

By Appointment Only  
Call 212-283-8200

## ► SECURITY HELP WANTED

NYS APPROVED  
**SECURITY TRAINING**  
8/16 Annual-In-Service  
Nr The Barclays Arena  
540 Atlantic Ave, Bklyn  
Near 2 3 4 5 B D N Q R  
& LIRR  
Tel: 718.855.0500  
web: www.thealmgroup.com

## TOWNENURSING.COM

**IMMEDIATE PLACEMENT!  
NOW HIRING!**  
NYS LICENSED  
**CNAS**

in BROOKLYN, BRONX,  
QUEENS, LONG ISLAND  
and WESTCHESTER

Murray@townenursing.com  
**718-998-4660**



**All shifts available!**

**Full Time & Part Time positions available**

## HHAs

**SCHAROME CARES**  
631 Foster Ave., Brooklyn, NY 11230  
PLUS NEW QUEENS LOCATION, By Appointment  
161-10 Jamaica Ave, 3rd Floor, Jamaica, NY 11432  
**IMMEDIATE OPENINGS!!**  
Full Time/Part Time/Live-In • Weekends/Weekdays  
Brooklyn, Queens and Bronx  
English, Russian and Spanish Speaking  
Please Call (718) 434-0909 Ext. 108 and ask for Alison

**YOU WILL NEED:**

- Valid HHA Certificate
- Social Security Card
- 2 references
- Up to Date Physical
- Proof of eligibility to Work in the US

**Call  
718-260-2555  
To Advertise Here**



**Need a Tutor?**  
Check out our  
Education Services and  
Tutors for more options

► DOMESTIC HELP WANTED

► DOMESTIC HELP WANTED

**NANNIES & HOUSEKEEPERS**

**Immediate Employment on Long Island. F/T or P/T**  
Experience, References, & Legal Papers a Must! Live in/out! No Fee!!

**ABSOLUTE BEST CARE**

Highest Pay!!!

CALL 516-802-3780

OR 631-486-4594

► HELP WANTED

\$8,000 COMPENSATION. Women 21-31. EGG DONORS NEEDED. 100% Confidential/ Private. Help Turn Couples Into Families with Physicians on the BEST DOCTOR'S List. 1 - 8 7 7 - 9 - D O N A T E ; 1-877-936-6283; www.longislandivf.com

► HELP WANTED

**HOME HEALTH AIDES IMMEDIATE WORK**  
for HHA's with Certificates + SIGN-ON BONUS\*  
Call for schedule of FREE Training Classes F/T or P/T Jobs, All Shifts/Locations!  
**HIGHER PAY & NO DUES**  
Vacation, Sick Pay, Bonus \*for qualified candidates



Bklyn/Queens 718-947-3682  
Nassau/Suffolk 516-634-2109  
Bronx/Westchstr 914-470-9924

**Cleaners NEEDED PT**

Sweeping, Mopping & Dusting Various shifts  
718-941-4699

EXP. SEAMSTRESS & DRESSMAKER NEEDED  
Must be able to construct whole garment.  
\*Immediate Opening\*  
CALL: 347-693-8946

► HELP WANTED

**PLUMBERS, BACKHOE OPERATORS**  
Plumbing position requires minimum of 3 years Exp. Requirements are Jobbing In & Out plus Alterations.  
CALL MATTHEW (917) 731-6208 (718) 649-0317

► HELP WANTED

► HELP WANTED

**DRIVERS**

Premier Paratransit is seeking Drivers with NYS CDL Class C with Passenger Endorsement

**COME IN FOR APPLICATION**

**940 REMSEN AVENUE**

(bet Ave D/ Foster Ave- Brooklyn)

Mon-Fri 8AM-7PM

Sat-Sun 8AM-4PM

**FT/PT DRIVERS WANTED**

For Bronx Based Access-A-Ride Company

- Must be at Least 21 Years Old
- Clean NYS CDL Drivers License
- Type C with Passenger Endorsement Required
- Knowledge of Five Boroughs a Plus

**We Offer:** Paid Training Upon Course Completion and Start In Revenue Service, Paid Sick and Personal Days, Paid Holidays, Two Weeks Paid Vacation After One Year, Medical Benefits, Competitive Salary, Safe Driving and Attendance Incentives.

Applicants Must Apply in Person at: 2383 Blackrock Ave., Bronx, NY 10462  
Contact: Roger Izzzi at 718-828-2472 ext 201 or rizzzi@cbttrans.com 9:00 am - 2:00 pm

► HELP WANTED

► HELP WANTED

The following positions are available working with developmentally disabled adults in Group Home in Canarsie Brooklyn:

One full time position for

Direct Care Counselors

experience preferred

Residence Manager-

Management experience working with

DD population preferred

Drivers needed

Interested applicants please

fax resume to 718-934-2669

or email resume to Karen@asbm.org

**MEDICAL RESEARCH DIRECTORY**

A better route to managing overactive bladder should have fewer bathroom stops

If the signs of overactive bladder (OAB) are becoming an all too familiar pattern, it may be time for a new direction.

The SYNERGY study is a research study examining an investigational combination of two drugs prescribed for OAB to see if, when taken together, they provide more relief than when taken on their own. If you experience the frequent and sudden urge to urinate, followed by leakage, you may be eligible to participate.

TO learn more, visit [www.OABandYou.com](http://www.OABandYou.com), or speak with our staff by contacting 917-409-3917 or [beverly@manhattanmedicalresearch.com](mailto:beverly@manhattanmedicalresearch.com)

► JOB INFORMATION

**AIRLINE CAREERS** begin here Get FAA approved Aviation Maintenance Technician training. Financial aid for qualified students - Housing available. Job placement assistance. Call AIM 866-296-7093

► JOB INFORMATION

**Leticia James Warns Consumers About Classified Ads**

Toll numbers may be a direct line to trouble. Classified ads are intended to help people by facilitating communication and advertising available services; however, some of the hotlines & service numbers in classifieds actually hurt the people who rely on them by cheating them of their hard-earned dollars. "Most newspapers print a disclaimer in their classified ad section to warn readers about numbers that are a direct line to trouble. Any number starting with 900, 540, 595 or 871 charges a fee beyond a local call. In some instances, ads initially advertise calls to a local number, but then direct callers to a second number starting with one of the paid exchanges. "Consumers must also question the legitimacy of vague classifieds because they too could be a scam. Before responding to an ad, consumers should verify the source of all information & always be wary about sending money or signing a contract with an unknown party."

Office of the Public Advocate

► HELP WANTED

► DISTRIBUTOR OPPORTUNITIES

FULLER BRUSH COMPANY DISTRIBUTORS NEEDED. Earn up to 46% profit servicing people in your area. No Investment. Call 1-800-683-2002

► EDUCATION SERVICE

All 5 Boros Intensive Review Mon thru Thur, Morn/ Eves New GED, GMAT, MCAT, GRE, SATs, Regents, LAST EXCELLENT RESULTS!! Sm. Student Faculty Ratio GED: 4 WEEKS \$150 Evenings Mon, Wed 7-9PM Mon thru Thur- 8-10PM 6 WEEKS Program Sun- 3- 6PM, Sat- 9-12PM & 1:30-4:30PM Add'l Prog For Students Who Have Difficulty w/Science/ Math. LSAT, High School & College Prep in All Subjects. PROF. DALEY: 718-369-0704

► TUTORS

99% PASSING RATE Improvement Guaranteed Licensed Math Instructor All levels Maths, incl GED, NY State Regents, College courses etc. Individualized attention. Fax service for Exams & Home Work [edmon101@aol.com](mailto:edmon101@aol.com) 1-347-267-7385

**PROFESSIONAL Tutoring Service** College Prep. 5 Boros All SUBJECTS Available Excellent Results!

REGENTS SAT1 & SAT2 Exams AP & ENTRANCE Exams. MCAT, GRE, GMAT Exams - LAST Cuny Exam Intensive GED & ESL Day Classes Start 6/09 Call Prof. Daley 718-369-0704

► FLEA MARKETS

St. Francis of Assisi - St. Blaise Parish Church Festival Sunday, June 15, 2014 10am thru 8pm

400 Lincoln Road between Nostrand Ave and New York Ave. in St. Francis School Yard.

Flea Market, International Foods on sale, Raffles throughout the day, games and prizes for all ages, live DJ, Bingo. Come one come all.

► MERCHANDISE FOR SALE

Kenmore Dryer white swing door 3.36 cubic feet electric works great pick up only \$350.00 347-857-5131

► MERCHANDISE WANTED

CASH for Coins! Buying ALL Gold & Silver. Also Stamps & Paper Money, Entire Collections, Estates. Travel to your home. Call Marc in NY 1-800-959-3419

► AUCTIONS

Buy or sell at AARauctions.com. Contents of homes, businesses, vehicles and real estate. Bid NOW! AARauctions.com Lights, Camera, Auction. No longer the best kept secret.

► FURNITURE

Beautiful Solid Cherrywood Bedroom Set New in box w/warranty Original \$3,000+ Sells for \$899 718-499-4499

► ANNOUNCEMENT

WERE YOU IMPLANTED WITH A ST. JUDE RIATA DEFIBRILLATOR LEAD WIRE between June 2001 and December 2010? Have you had this lead replaced, capped or did you receive shocks from the lead? You may be entitled to compensation. Contact Attorney Charles Johnson 1-800-535-5727

► FLEA MARKETS

► LEGAL

**NOTICE IS HEREBY** given that an Order entered by the Civil Court, Kings County on 06/10/2014, bearing Index Number NC-000606-14/KI, a copy of which may be examined at the Office of the Clerk, located at 141 Livingston Street, Brooklyn, NY 11201, grants me (us) the right to: Assume the name of (First) Willis (Middle) Charles (Last) Mark. My present name is (First) Willys (Middle) Charles (Last) Mark AKA Willis C. Mark AKA Willis Mark AKA Willic Charles Mark. My present address is 552

► LEGAL

East 53rd Street, Brooklyn, NY 11203-. My place of birth is Trinidad and Tobago. My date of birth is November 17, 1949.

► LEGAL

**Notice is hereby** given that an on premises license, #TBA has been applied for 10-12 Devoe St Rest Inc. to sell beer, wine and liquor at retail in an on premises establishment. For on premises consumption under the ABC law at 10-12 Devoe Street Brooklyn, NY 11211.

**LEARN TO EARN!**  
EDUCATION & CAREER TRAINING



**BOOST YOUR RESUME. INCITE YOUR CAREER**

Gain the media skills that will amplify your professional repertoire. Take low-cost classes in video production, marketing, and more.

[BRICartsmedia.org/bme](http://BRICartsmedia.org/bme)  
718.683.5645

**BRIC House**  
647 Fulton Street  
Brooklyn, NY 11217

# LEARN TO EARN!

## EDUCATION & CAREER TRAINING

### HHA/ PCA FREE Training Classes

Train to become a NYS Certified Home Health Aide in just 16 days  
Call today to register for upcoming classes!  
Jobs available upon successful completion  
Excellent Pay and Flexible Hours

**MJHS®**  
HOME CARE SOLUTIONS

**Call 718-942-5888**

We are an equal opportunity employer dedicated to a drug-free workplace.  
All training conducted by Bestcare, Inc. through approved NYS DDH Training Program and under contract with MJHS Home Care Solutions

### BABY NURSE & CHILD CARE CLASSES

Get Your Certificate Now!  
First Aid • C.P.R. • B.L.S. • A.E.D.

Become a Baby Nurse or a Child Care Provider Today!  
(Baby Nurse is non-medical and known as a Newborn Care Specialist.)

We give more knowledge in order for you to be more confident and competent in your job!

**GUINI AGENCY**  
Licensed & Bonded

**718-633-7449 or 646-474-6623**

**Access Careers Brooklyn**  
www.AccessCareers.Edu

**Call Now 866-488-6510**

### Are You HHA? Upgrade to PCT

- ◆ Medical Assistant
- ◆ Dental Assistant
- ◆ Nurse Aide (CNA)
- ◆ EKG Phlebotomy
- ◆ Patient Care Tech
- ◆ Physical Therapy Aide
- ◆ Computer Programming
- ◆ Computer Networking
- ◆ Pharmacy Technician
- ◆ Medical Billing & Coding

- \* Morning, Evening & Weekend Classes (4 to 6 Weeks)
- \* We Accept Vouchers (Workforce, ACCES-VR, HRA)
- \* Onsite State & National Examination Center
- \* Outstanding Job Placement Assistance
- \* Close to Subway 2, 3, 4, 5, A, C, G, Q, D, E, F, at Hoyt St.

**NO HS DIPLOMA OR GED REQUIRED**  
Licensed by NYBED & Accredited by CDE

All Medical Assistant Com. Programming & Networking Students will receive FREE MONTHLY UNLIMITED METROCARD up to 9 Months.

### ENTER A CAREER IN HEALTH CARE

#### COMPLETE COURSES IN 4 TO 8 WEEKS

- Nurse's Aide Training 5 to 6 Weeks.....\$685
- Patient Care Tech (PCT), (PCA) Nurse Tech.....\$690
- HHA & PCA .....*Credo/French Students Welcome*.....\$650
- Phlebotomy & EKG Training.....\$690
- Having Difficulty Passing the Nurse Aide State Board Exam? TRY OUR 2 WEEK REVIEW COURSE.....\$2,500
- PHARMACY TECH 8 WEEKS.....\$900
- Nurse Aides Can Become Home Health Aides in 10 Days...\$550

**Morning, Evening & Weekend Classes**  
**\$50 REGISTRATION FEE**  
**NO HS DIPLOMA OR GED REQUIRED**

**DAISLEY II INSTITUTE, INC**  
495 Flatbush Ave. • 2nd Flr. Brooklyn  
(bet. Lefferts & Empire Blvd.)  
**718-467-8497**

### FREE 15-week job training program for homeless & low-income women

#### First Step Program

- Computer Training - Microsoft Word, Excel, PowerPoint, Outlook
- Internet Research • Resume Writing • Interviewing Skills
- Job Placement Assistance • Self-Esteem Building
- 2 Month Internship • Case Management • Typing
- Literacy Building • Mentoring • Yoga & Meditation
- Support Groups • Empowerment

GED not required • New class starting soon!

**FREE Continental Breakfast & Metrocards Provided**

For more information, please call (212) 776-2074



### BABY NURSE CLASS

- Best Newborn Care class in the industry!
- Hospital Instructors & Full Certification!
- Includes Infant CPR

**Become a Baby Nurse Today! \$300**

### ABSOLUTE BEST CARE, INC.

Get your Certificate in one day

Baby Nurse is non-medical & known as a Newborn Care Specialist

**212-481-5705 • 732-972-4090**

### HHA/CNA/ EKG/ Phlebotomy

Job Placement Assistance Available

Start Dates for Next Classes

HHA Day 06/23	CPR 06/14	CNA Day 07/28/14
Wk/End 7/26/14		(Wk/End) 07/12/14

**Pre-Registration Going On Now**  
State Board Exam on Premises for CNA Class  
Call Today To Register-Class Fills Quickly

**718-206-1750**

www.NYHHC.com

New York Institute of Healthcare Careers, Inc.  
161-10 Jamaica Avenue, 3rd Flr. Jamaica, NY 11432  
Lic. by NYSED



### ADL INSTITUTE

HHA, CNA, PCA UPGRADE, CNA TO HHA

Schedule & ongoing registration  
Weekend, full time or evening courses

**NO GED OR HS DIPLOMA NEEDED**

Assistance for slow learners  
and Long time out of school  
placement assistance

**718.349.8003**

EQUAL EMPLOYER OPPORTUNITY

**PHORNER TRAINING CENTER**  
CNA • HHA • EKG • PHLEBOTOMY • CPR  
Licensed By New York State Education Dept.

### COME JOIN US FOR CAREER TRAINING

- Nurse Aide/Assistant/(CNA)
- Home Health Aide (HHA) (English & Espanol)
- (EKG/Phlebotomy) • CPR (By AHA Valid for 2yrs)
- Patient Care Technician

**GET THE SKILL YOU NEED TO SUCCEED!!!**  
Invest in Yourself!



#### Flexible Schedules

(Day, Evening & Weekend classes)  
Easy Weekly Payment Plans Available

**Tour and Get A Feel For Our School.**

540 E. 180th St.  
Suite 201, 2nd Floor  
(Corner of 180th St. & 3rd Ave.)  
Bronx, NY 10457

**Call: 718-484-7604 www.phnxcna.com**  
All Major Credit Cards Accepted • Close to Bx 15,36,41 Buses and D,2,4,5 Trains

### CUDLEY'S TRAINING PROGRAM CNA CLASSES Evenings & Weekends HHA CLASSES in English & Spanish

Train in the Bronx but work anywhere  
in the Greater Metropolitan Area

Educating people for jobs that help the  
Elderly and infirm in our Community.

#1 in Bronx Community since the 90s

Trusted Tried and True

No shortage of jobs for HHAs

Open weekdays and weekends

**Bronx Location**

391 E. 149th St. @3rd Ave. Suite 521

**718-401-9298**

[www.cudleys.com](http://www.cudleys.com)

**WE BELIEVE IN Career Placement**

Our Career Services team is dedicated to helping you find career opportunities in the business or medical field.

**Associate & Bachelor Degrees**

Accounting      Medical Assisting  
Information Sciences      Health Information Technology  
Business Administration      Patient Information Management

**Summer Session in our New Campus**  
Call to register today

For more information on our academic programs, please visit [plazacollege.edu/academic](http://plazacollege.edu/academic)

**PLAZA COLLEGE** 718-514-6820  
[PlazaCollege.edu/info](http://PlazaCollege.edu/info)

# LEARN TO EARN!

## EDUCATION & CAREER TRAINING

**We take care of your health**

FCI can make it easy to change your life with a new career!

Choose from the following fields...

- Medical Office Assistant - Medical Office Assistant with GED
- Pharmacy Technician - Certified Nursing Assistant
- Phlebotomy and EKG - Medical Billing and Coding
- Day and Evening Classes Offered

Students enrolled in our Medical Office Assistant or Pharmacy Tech course are eligible to participate in The Federal Pell Grant Program as well as the NYS Tuition Assistance program. All graduates will be offered Full Job Placement Assistance.

**Call us 718-535-3333**

[frankincareer.com](http://frankincareer.com) [www.frankincareer.edu](http://www.frankincareer.edu)

**BROOKLYN:**  
5323 Fifth Avenue  
Brooklyn, New York 11220  
Phone: (718) 535-3333

**LONG ISLAND:**  
91 North Franklin Street  
Hempstead, New York 11550  
Phone: (516) 481-4444

**FCI**  
The Franklin Career Institute

**All Medical Office Assistance Students will receive all their text books on a Brand New iPad... yours to keep upon graduation.**

**BRAMSON ORT COLLEGE** [www.BramsonORT.edu](http://www.BramsonORT.edu)

**Apply Today 877-479-0705**

Our mission is education. Our focus is your career.

- Paralegal
- Medical Assistant
- Graphic and Game Design
- Electronics Technology
- Business Management
- Computer Technology
- Accounting
- Administrative Assistant
- Renewable Energy
- Computer Programming
- Pharmacy Technician
- CADD & HVAC and more!

Affordable Tuition • Financial Aid Available • Flexible Class Schedules  
National & Industry Exam Prep • Job Placement Services • Career Internships

Phlebotomy/ EKG \$495  
CNA Classes \$700

**REGISTER NOW!**  
718-693-2600  
Next Step Institute  
Next to Bobby's Dept

**To Advertise Here**  
Call 718-260-2555  
OR  
Fax 718-260-2549

**UNIVERSAL EMERGENCY CARE TRAINING INC.**

[emslife.com](http://emslife.com)

**Become a Professional Get the Training Days, Evenings, Weekend Classes**

**EMT, ACLS, PALS, First Aid, CPR, AED and EKG**

**RN, LPN Review, R.N. Clinical Workshop**  
196 State Street Brooklyn New York 11201

**Call for more information 718-855-7366**

G	L	I	D	E	W	H	O	N	E	M	O	
R	U	N	O	N	H	O	W	S	E	T	I	N
I	N	C	U	R	E	E	L	T	E	N	S	E
P	E	A	B	O	D	Y	E	D	E	M	A	S
	T	O	O	A	T	O	P					
B	I	B	T	O	R	R	N	U	T	J	O	B
A	D	A	M	R	I	T	Z	P	R	U	D	E
M	E	S	A	S	E	W	E	R	E	D	D	A
B	A	S	I	L	L	O	B	E	F	E	E	S
I	S	O	M	E	R	R	U	F	F	A	R	T
	D	I	S	K	I	R	K					
D	R	A	G	O	N	S	T	O	O	L	E	D
L	O	U	S	E	E	G	O	Z	A	I	R	E
O	L	D	E	R	E	R	R	E	L	F	I	N
P	L	E	A	R	U	T	N	A	T	E	S	

**Find Your New Career in Our Learn to Earn Education & Career Training Section**

**ATTORNEY**

Law Offices of Marina Shepelsky P.C.

**Immigration and Family Law**

Green Cards • US Citizenship • Divorces  
Child Support • Visitation  
2306 CONEY ISLAND AVE. • BROOKLYN, NY 11223

Tel. 718-769-6352  
www.shepelskylaw.com

We specialize in difficult cases, prior attorney mistakes, deportation, court proceedings  
Serving the New York community since 2002

**ATTORNEY**

**SOLVE JAMAICAN LEGAL ISSUES IN NEW YORK AT NO EXTRA COST**



MEET HERE™

DONE HERE™



**ALIMI BANJOKO**

Registered Foreign  
Legal Consultant

NY, CA, & ONTARIO  
BARRISTER- England & Wales  
& ATTORNEY-AT-LAW- Jamaica

**718-385-5300**

PROPERTY \* BUSINESS \* PROBATE  
\* DIVORCE \* PERSONAL INJURY

OFFICE: 5306 Church Avenue, Brooklyn, New York 11203

Website: www.banjokomcglashanlaw.com

Email: ab@banjokomcglashanlaw.com

**ATTORNEY**

**GET JUSTICE!**

Personal Injuries, Police Brutality  
Construction & Auto Accidents  
Civil & Commercial Litigation  
Medical Malpractice  
Wills, Trusts and Estates



CALL TODAY FOR YOUR FREE CONSULTATION!!

Law Office of Philip W. Coleman, LLC

881 Gerard Ave., Suite 4  
Bronx, New York 10452

Call Toll Free! 800-723-1032

www.colemanlawny.com

**ATTORNEY**

**DWI • ASSAULT • DRUGS**  
FREE Consultation • All 5 Boros  
**CRIMINAL DEFENSE ATTORNEY**  
**Former NYC Prosecutor**



Law Offices of Lowell J. Sidney  
888-222-0513  
www.sidneylaw.com



*Immigration problem?  
You need an experienced attorney who can  
protect your rights honestly and professionally.*

---

IMMIGRATION ATTORNEY  
**CHRISTI M. GELO, ESQ.**

135-24 Hillside Avenue  
Richmond Hill, NY 11418  
(718) 770-7301

---

- Deportation/ Removal Proceedings
- Family and Employment Based Petitions
- Political Asylum
- 24 Hour Emergency Service for Detained Individuals
- Reasonable fees and special fees for victims of domestic violence\*
- Other practice areas include Bankruptcy, Divorce, Family Law and civil litigation. .

---

FREE CONSULTATION | LATE EVENING & WEEKEND APPOINTMENTS | DEDICATED TO INTEGRITY, HONESTY & FAIRNESS

\* Special fees for victims of domestic violence filing petitions under the Violence Against Woman Act

**ATTORNEY**

**Social Security/ SSI Disability**

Convenient to all Boroughs and Long Island

- NO FEE unless successful
- Over 40 years experience
- Personal and Friendly Service

Michael Schoffman  
26 Court Street  
718-852-0900

**ATTORNEY**

**HAVE YOUR RIGHTS BEEN VIOLATED?**  
Call 718-243-0994

**CIVIL RIGHTS**

- Police Brutality
- Excessive Force
- False Arrest
- False Imprisonment
- Malicious Prosecution

---

<b>ACCIDENTS</b>	<b>MEDICAL MALPRACTICE</b>
Motor Vehicle	Medical Misdiagnosis
Slip and Fall	Surgical Errors
Trip and Fall	Wrongful Death
Construction Accidents	

**WALE MOSAKU, P.C.**  
LAW OFFICES  
25 Bond Street, Brooklyn, New York 11217

**ATTORNEY**

**LEGALLY SPEAKING RADIO SHOW**  
With Attorney Antoinette Osbourne  
Sundays, 9-9:30am  
"On 93.5 FM"

Keeping our community informed on  
Immigration • Bankruptcy  
Divorce and Real Estate

Call 718-502-9137 for more info



**ATTORNEY**

**Antoinette Osbourne, ESQ.**  
By Appointment Only

IMMIGRATION- \$500 and up PLUS USCIS FILING FEES \*  
UNCONTESTED DIVORCE- \$400 and up + court fees (excludes svc costs)\*  
WILLS- \$300 and up\* BANKRUPTCY  
DIVORCE, CHILD SUPPORT, ADOPTION  
REAL ESTATE, FORECLOSURE DEFENSE, LOAN MOD ESTATES  
\*conditions apply to quoted prices above.

QUEENS 162-02 Jamaica Avenue #5, Jamaica, NY 11432  
(Entrance On Union Hall Street)  
Rockland County 80 E. Rte 59 Suite A, Spring Valley NY 10977  
Tel. 718-502-9137 Fax 718-301-1233  
osbourne@osbournelaw.com

**ATTORNEY**

**Protecting Your Rights and Assets**

- Registered Patent Attorney (Patents, Trademarks, Copyrights and other intellectual property rights)
- Wills & Trusts
- Real Estate Closings

DL BENTLEY LAW GROUP PLLC  
Tel: 718-260-9556  
Fax: 718-596-2610  
Email: dlbentleyesq@gmail.com



Dwayne L. Bentley  
Attorney-At-Law  
26 Court Street Suite 405, Brooklyn, NY 11242

**ATTORNEY**

**LOW FLAT FEE**

**BANKRUPTCY**

**FREE CONSULTATION**

**CONSUMER BANKRUPTCY**

- CHAPTER 7 & 13
- ELIMINATE CREDIT CARD DEBT
- STOP CREDITORS HARASSMENT
- STOP FORECLOSURE
- STOP GARNISHMENT

**DENRICK W. COOPER, ESQ**

**718-479-9500**

CooperLegal@aol.com  
207-23 Hillside Ave  
Queens Village N.Y. 11427  
WE ARE A DEBT RELIEF AGENCY

**ATTORNEY**

**BANKRUPTCY**

STOP Foreclosure/wage garnishments/harassing telephone calls/eliminate mortgages

SAVE Car, Home, Business

**LOAN MODIFICATION**

**DIVORCE**  
we walk you through this difficult life changing process

**IMMIGRATION**  
E-Z Payment Plans/Evening & Weekend Appts  
Avail. Brooklyn office by appointment only

**LAW OFFICE OF NARISSA A. JOSEPH**  
212-233-3060  
277 Broadway, Suite 501, New York, New York 10007

**ATTORNEY**

**NEED A LAWYER?**  
Call the Law Offices of  
**CARL C. BELGRAVE**

**Divorce**  
**Immigration**  
**Bankruptcy**

**General Civil Litigation**

- Personal Injury/Wrongful Death
- Medical Malpractice

Employment Discrimination/Sexual Harassment  
Landlord-Tenant/Real Estate  
Guardianship/Wills/Estates  
Criminal Law

Weekend Hours Available by Appointment



**718-522-3033**  
26 Court Street  
Suite 1710  
Brooklyn, NY 11242

**ATTORNEY**

- FALSE ARRESTS
- ACCIDENTS
- CRIMINAL DEFENSE
- POLICE BRUTALITY
- PERSONAL INJURY
- TRAFFIC VIOLATIONS



**LAW OFFICE OF  
MICHAEL J. LARSON, P.C.**  
401 Broadway, Suite 806, New York, NY 10013

Free Consultation • 212-528-0886  
Email: Michael@mlarsonlaw.com • www.mlarsonlaw.com  
\*No fee on false arrest or personal injury cases unless you recover\*  
Former Prosecutor and United States Army Attorney

**ATTORNEY**

**IMMIGRATION GREEN CARDS**

Work Permits • Deportation/Removal  
Appeals • Unjust Convictions • Investor  
Employment • Marriage • Criminal •  
Landlord/Tenants • Bankruptcy • Accidents

**ATTORNEY**

**FREE CONSULTATION**



- Immigration
- Divorce
- Accidents
- Landlord/Tenant



Sunday and evening appt.  
Call Attorney Abraham Chananashvili  
Tel. **646-704-1062**  
Conveniently located in Brooklyn, NY 11234

**ATTORNEY**

*Oladeji O. Bolaji  
& Associates*  
Your One Stop Legal Center

- Real Estate
- Business Incorporation
- Immigration
- Change of Name
- Wills
- Landlord/Tenant
- Divorce

**718-298-5251**  
www.oladejibolajilaw.com  
91-16 Sutphin Blvd, Suite 202, Jamaica, Queens NY 11435

**ATTORNEY-IMMIGRATION/CRIMINAL DEFENSE**

**FREE OFFICE CONSULTATION**  
212-571-9200



Feiner & Lavy, P.C., Attorneys at Law  
www.FNLPC.com 325 Broadway Suite 401  
NY, NY 10007  
عبرית, Español, العربية

Former U.S. Immigration Officer  
**Lecturer, Author  
ROBERT LIEBER**



Attorney & Counselor At Law  
PAYMENT PLAN AVAILABLE

130 West 42nd St., Suite 1002, NY, NY 10036  
**516-728-7253**

**TIMES SQUARE**  
1 2 3 A C E

**ATTORNEY - PERSONAL INJURY**

**INJURED?  
NEED A LAWYER?**



212-571-9200  
Car Accidents, Slip & Fall, Medical Malpractice, Dog Bites, Defective Products  
**FREE CONSULTATION • NO WIN, NO FEE**  
Over \$76 million in Claims • 98% WIN RATE!  
**Feiner & Lavy, P.C. Attorneys at Law**  
325 Broadway, New York, NY 10007  
عبرית, Español, العربية

**ATTORNEY**

**PERSONAL INJURY ATTORNEY**

- Car Accidents • Slip/Trip & Fall
- Construction Accidents • All Injury



**212-227-2100**  
**Pospis Law, PLLC**  
233 Broadway, Ste 2707, New York, NY 10279  
The Woolworth Building  
www.pospislaw.com  
ASK FOR MIKE POSPIS  
No Fee Unless You Recover

**ATTORNEY**

**IMMIGRATION**  
All your immigration needs  
Real Estate and Other Legal Matters  
**BROOKLYN LOCATION AVAILABLE**  
Call and inquire about immigration reform updates **718.851.4521**  
Cedarhurst-575 Chestnut Street, NY 11516  
**516.374.5467**  
CALL FOR APPOINTMENT  
**H. ZALCMAN-ATTORNEY AT LAW**

**ATTORNEY**

**CARIBBEAN IMMIGRATION AND LEGAL DEFENSE CENTER**  
77 Water Street, NYC 10006  
30 Years Attorney Experience In

FAMILY PETITIONS • MARRIAGE CASES  
ADOPTIONS • NATURALIZATION  
REMOVAL & DEPORTATION PROCEEDINGS  
ADJUSTMENT OF STATUS • WORK PERMITS • MOTIONS TO REOPEN  
FIANCE VISAS • STOKES INTERVIEWS • ADVANCE PAROLE  
DIVORCE & ANNULMENT • FAMILY COURT • CRIMINAL COURT  
SUPREME & CIVIL COURT LITIGATION • REAL ESTATE  
Call: **212-349-4542**

**ATTORNEY**

**Law Office of Lola Oni**

**\$80 Consultations**

**Let Us Be Your Strength!**



- Immigration
- Landlord/Tenant
- Real Estate
- Family Law: custody, child support
- Criminal - And more

**718-375-6800**  
1850 Flatbush Ave., 2nd Floor (between Ave. K & L)

**DIVORCE/IMMIGRATION**

**UNITED BUSINESS SERVICE**

**\*Divorce \$249** + court fee  
no spouse signature required, no court appearance required  
\*Divorce usually finalizes within 60 days

Immigration **\$80 up**  
Tax ID **\$120**

\*the individual providing assistance to you is not an attorney licensed to practice law or accredited by the board of immigration appeals to provide representation to you before the bureau of citizenship and immigration authorities and may not give legal advice or accept fees for legal advice.  
**3618 Church Ave. Brooklyn NY 11203**  
**718-941-5100**

**ATTORNEY**



**LEVINE AND WISS, PLLC**  
Attorneys at Law

**ALL TYPES OF ACCIDENTS!**

- AUTO ACCIDENTS
- MALPRACTICE
- SLIP/TRIP & FALL

**&**

**INJURIES!**

- CONSTRUCTION ACCIDENTS
- ALL OTHER TYPES OF INJURY CASES



Proud to announce the opening of our newest location in Brooklyn.  
New York State's Sixth winningest Law firm for 2012. Source—Verdict Search  
Prior Results Do No Guarantee A Similar Outcome

**Se Habla Español**  
**1-888 GOT HURT (468-4878) • 718-575-2222**  
455 UTICA AVENUE BROOKLYN, NY 11203  
510 HEMPSTEAD TPKE, SUITE 206 WEST HEMPSTEAD, NY 11552

# LEGAL DIR. & HERE'S MY CARD

## To Place Your Ad Call 718-260-2555

**DIVORCE**

### Absolute Divorce

Starting at **\$219** + court fees

**Hablamos Español** **FREE CONSULTATION** **RUSH SERVICE AVAILABLE**

80 Broad Street, 5th Floor, New York, NY 10004  
**212-504-2985**  
www.absolutedivorceinc.com  
all major credit cards accepted  
"Must bring in this ad for \$219 Special"

### T-SHIRTS PRINTED

By Makalani  
**FULL COLOR SILK SCREEN PRINTING**  
Small or Large Orders  
FAST-EFFICIENT SERVICE • 20 YEARS EXPERIENCE



FUND RAISERS • FESTIVALS  
BASKETBALL LEAGUES  
FAMILY REUNIONS

**347.407.6900**  
email: makalani45@gmail.com  
LOCATED IN MT VERNON, NY • FREE SHIPPING - USA

**EXTERMINATOR**

### BED BUGS



**ACTION EXTERMINATOR**  
**212-465-7524**

10% Discount if you ask for Charles

**MACHINERY & EQUIPMENT**

**WATER PUMPS and GENERATORS**  
RENTALS • SALES • SERVICE



**HONDA Power Equipment**

"POWER WHEN YOU REALLY NEED IT"

**LAPIETRA MACHINERY & EQUIPMENT INC.**  
1320 Third Ave., Brooklyn, NY 11202 (4th Fl)  
(800) 942-9950  
Buy On-Line! www.LATool.com

**APPLIANCE REPAIR**

### APPLIANCE REPAIRS

WE REPAIR ALL BRAND NAMES

- REFRIGERATORS
- AIR CONDITIONERS
- Ovens
- STOVES
- DISHWASHERS
- WASHERS
- DRYERS
- HEATERS
- ETC.....

10% OFF W/ THIS AD  
LIC. & INS.

Ask for Richie **646-399-5366**

**COMPUTER REPAIR**

- ✓ **COMPUTER REPAIR**
- ✓ **UPGRADE**
- ✓ **TROUBLESHOOTING**

Virus Removal • Data Recovery  
Cracked Laptop Screen and  
Broken Power Jack Replaced

Call James  
**646-281-4475**  
**718-324-4332**

**ONE HOUR PEST CONTROL**



**STOP LIVING WITH ROACHES & MICE**

Monthly Roach Service .....\$29.99  
Monthly Mice Service.....\$29.99  
Monthly Mice & Roach Service .....\$39.99

STUDIOS, 1,2,3 BEDROOM APARTMENTS **CALL 212.289.0400**

**MOVING**

### SP MOVING

All Types of Moving  
Reliable  
Dependable  
Reasonable Rates



Free Estimates  
We Do Rubbish Removal

**718-339-8888**

**CARPET & UPHOLSTERY**

### TRUE CLEAN CARPET & UPHOLSTERY

CLEANING SPECIALIST  
RESIDENTIAL & \*COMMERCIAL

**CARPET**  
\$50 per room  
\$25 per hall  
\$5 per step

**UPHOLSTERY**  
\$90 Sofa  
\$75 Luv Seat  
\$60 Chair

Call **718-287-0579**  
\*Call for Commercial Carpet & Upholstery Cleaning prices

**CONSTRUCTION**

**KW Construction & Renovation Inc**  
General Contractor  
Yonkers Lic. #5056  
Westchester Lic # : WC-22361-109  
Lic# 1395520

### WATERPROOFING & ROOFING

**ALL KINDS OF ROOFS**

- Steam Cleaning • Brick Pointing • Masonry Work
- Scaffold Work • Bathroom/Kitchen/Tile • Sidewalks
- Stucco • Painting • Sheetrock Work • Siding/Gutter

**NOBODY CAN BEAT OUR PRICE!!!**

30 Years Experience  
We can help you remove all kinds of violations

**EMERGENCY SERVICE**

FREE ESTIMATES  
FULLY INSURED  
LICENSED BONDED

1284 Mace Ave, Bronx, NY 10469  
AHMED: 718-652-6444/Cell: 917-567-2143

**FURNITURE REUPHOLSTERY**

### Perfect Touch Decorators

Expert Reupholstery All Furniture

### AMAZING SPECIAL!

**Kitchen Seats \$55**  
Including Vinyl (pullover)

Verticals/Mini Blinds • Cushions Refilled  
Recaning • Slipcovers - Plastic & Fabric

**FREE Shop-at-Home Estimates**  
Quality Service Over 30 Years Experience  
**718-263-8383**

**PAINTING**

### Aldo's Painting & Decorating

Commercial & Residential

- Interior & Exterior Painting
- All Phases of Carpentry
- Wood Floors
- Faux Finish
- Plastering
- Staining



**718-809-5091**

**CARPET CLEANING**

### Jose Carpet Cleaning

Commercial/Residential

- Steam & Shampoo • Traffic Lane Removal
- Sanitizing Water Damage
- Deodorizer, Scotchguard
- We Clean Fire & Water Damages • Restoration
- We Fix Foundations & Waterproof
- Ceramic Tiles, and Tiles Ground
- Stripping, Waxing & Polishing

No Job to Big or too Small  
"WE CLEAN WHERE OTHERS FEAR TO TRY"  
Tel: **917-560-6569**

**CONSTRUCTION**

### NEW HEIGHTS CONSTRUCTION LLC

Siding • Windows • Roofing  
Fences • Kitchens • Painting • Baths  
Basements • Decks • Doors  
Awnings • Patio Enclosures  
Brick Pointing • Concrete Stucco

FALL SPECIALS ON WINDOWS

VISIT OUR ONLINE SHOWROOM

NYC License #1191201  
www.newheightsconstructionllc.com

**800-525-5102**  
**718-767-0044**

FREE ESTIMATES

**HOME IMPROVEMENT**

### HERON CONSTRUCTION

Specializing in:

- Kitchens & Bathrooms • Finished Basements
- Painting & Plastering
- All Kinds of Carpentry & More

Lic. #1252474 • Fully Insured

Professional Work You Can Trust

**718-450-1851**  
Fax: **718-277-1963**  
www.HeronConstruction.net  
email: heron80@aol.com

Call Today for a FREE ESTIMATE

**CONTRACTOR**

### ALAM ROOFING & WATERPROOFING

**GENERAL CONTRACTOR**

- Painting
- Interior/Exterior • Plastering
- Skylight • All Types of Roofing
- Sheet Rock • Waterproofing
- Carpentry • Sidewalk
- Steam Cleaning • Pointing
- Brownstone Repair

All Kinds of Cement Work  
FREE Estimates/Fully Insured/

**256 East 9th Street**  
**Brooklyn, NY 11218**

Tel **718-871-1999**  
Cell **917-295-3948**

**CHIMNEY & FIREPLACE**

### CHIMNEY & FIREPLACE

Cleaning & Inspection

- Clean • Repair • Re-Line
- Rebuild All Masonry Work
- Roofing & Siding • Blockages Removed
- Gas Company Shut-offs
- Oil Burner Chimneys
- Violations Corrected
- Carbon Monoxide Spillage Resolved
- Gas Furnace Chimneys

**\$59.00**

FREE ESTIMATES  
SENIOR DISCOUNTS

**ALL BOROUGH CHIMNEY & FIREPLACE, Inc.**  
**718-755-3046**

LIC. & INSURED DCA #1280321  
24/7 Emergency Service

**DRAIN CLEANING**

### M&S Sewer & Drain Cleaning Services

As Low As **\$75** All Work Guaranteed

Any main sewer, sinks, yard drains, leaders, bathtubs, shower stalls, toilets.  
Your Satisfaction is Our Main Priority  
Family Owned Business

Ask about our plumbing specials  
Call for Prompt Service **347-515-5387**

**JEWELRY**

**GOLD**  
Is Up To \$1500 An Oz  
Turn Your Unwated Jewels Into

### C.A.S.H.

YONKERS GOLD, SILVER & DIAMOND BUYERS

MON -SAT 10AM- 6:30PM

2050 CENTRAL PARK AVENUE,  
YONKERS, NY (4 Blocks south of world famous nathans just north of KFC)

**1-800-510-7073**

## ► HERE'S MY CARD

**TRANSLATION SERVICES**  
**INTERNATIONAL DRIVER'S LICENSE**  
 THIS IS TRANSLATION OF YOUR FOREIGN DRIVER'S LICENSE ISSUED BY INTERNATIONAL TOURIST CLUB

NEW YORK STATE LEGAL REGISTRATION No: 200211  
**718-232-1223**

INTERNATIONAL TOURIST CLUB

INTERNATIONAL DRIVING PERMIT  
 PERMISO DE CONDUCIR INTERNACIONAL  
 LICENCIA DE CONDUCIR INTERNACIONAL

**TAX ID NUMBER**  
**6408 14 AVE BROOKLYN, NY 11219**

Office hours: [www.itconline.info](http://www.itconline.info)  
 Mon-Fri 10am - 7pm  
 Sat-Sun 10am - 4pm

SUBWAY TRAINS:  
 D TO 42 ST  
 N TO NEW UTRECHT AVE.

## WINDOWS

**MAKE YOUR HOME "ENERGY EFFICIENT"**  
**SAVE BIG WITH "STAN THE WINDOWMAN"**

Call: Stanley @ WE SELL THEM • WE INSTALL THEM  
 STAN'S WINDOW SERVICE INC. NYC# 1471637  
**516-790-1376** NASSAU # H0811990000  
 thewindowman3@verizon.net LICENCED & INSURED

**HUGE SAVINGS**

## ► REAL ESTATE

### ► BROOKLYN APTS UNFURN

**CANARSIE**  
 (Paerdegat Area)  
 Spacious, Split Level.  
 2 Bedroom Apt.  
 Clean w/ new appls.  
**Fine Choice RE:**  
**718-363-2200**

FFEPS ,SECTION 8  
 HASA, APARTMENTS  
 Available in ALL Boro's  
 1, 2, 3 & 4 Bedrooms  
 Landlords are welcome  
**ASSETS RE GROUP**  
**347-628-5143**

**PARK PLACE**  
 4 Bedrooms.  
 \$2,500 Month  
 Close to Trans With  
 Immediate Occupancy.  
**CALL BROKER**  
**917-541-3679**

### ► BROOKLYN ROOM FURN

All Local Areas  
 Pvt Entry, Bath, Cooking  
 1 Person \$125wk/ up  
 2 Person \$150wk/ up  
 Studios \$900mo/ up  
**AGENT**

**212-697-3598**  
**LANDLORDS:**  
 List your rental FREE

**EAST FLATBUSH**  
 Furn rooms for rent, Near  
 transportation \$850/ month  
 \$185/week 718-703-1730

**FLATBUSH, Furnished**  
 rooms. Income verification,  
 \$135-140/week. 2 weeks  
 security. Non-smoking.  
 347-528-4931 or  
 718-778-9287

## ► R.E., SERV., & AUTO

### ► BROOKLYN CO-OP FOR SALE

Flatbush/Flatlands  
**Co-Ops From \$130,000**  
**Ready To Go!**  
**M C Realty**  
**718-484-8582**

### ► BROOKLYN HOUSE FOR SALE

**ATTENTION HOME/PROPERTY OWNERS**  
 List your properties with us. Qualified buyers are waiting  
 Foreclosure & short sale specialist  
**Choice Realty**  
**646-732-5101**

**East New York**  
 2 family brick  
 3 BR dplx w/ 2 baths over  
 2 BR's w/ 1 bath. Fin bsmt, pkg for 2 cars.  
 Cozy bkyd. \$595K  
**Belle Plaine Realty**  
**917-748-2975**

Flatbush Brooklyn Ave & Ave D  
 Semi attached house 4 bedrooms backyard  
**718-677-7160 Broker**

### ► BROOKLYN HOUSE FOR SALE

### ► BROOKLYN OPEN HOUSE

Canarsie OPEN HOUSE  
 Every Thurs, 4-8 PM  
 Every Sun, 12-4 PM  
**548 EAST 87th ST**  
 (Foster & Farragut)  
**NEW CONSTRUCTION CONDOMINIUMS**  
**LOFT 87**  
 Luxury 2 Bdrms, 2 Baths, SS Applis, Parking, Cath Ceilings, Terraces, Recessed Lighting, Nr BJ's & Transp, \$379K-\$429K

**COLDWELL BANKER**  
**LABARCA R.E.**  
**718-258-1222**

**OLD MILL BASIN OPEN HOUSE**  
**SUNDAY 12-2 PM**  
**1504 EAST 45th ST.**  
 (K&L/ Flatlands)

Lovely det 1 fam. Spacious 2 bdrm duplex w/ lrg LR w/ vaulted ceiling & skylights, FDR, new kitch w/S.S appls, new full C/T bath & full bsmt. Hdwd floors thruout. Exclnt cond. Bright & airy home. Prvt bkyrd w/ new cement patio. Buy with \$10K down! Mid \$300's

**Century 21**  
 Homefront  
**718-252-6060**

### ► BROOKLYN HOUSE FOR SALE

## STOP RENTING AND BECOME A HOMEOWNER

**WE HAVE HOMES IN BROOKLYN AND QUEENS.**  
 1-4 Family Homes w/ Low or Zero (VA) Down Payments & No Closing Cost.  
**INVESTORS:**  
 We have Hotels, Apt Buildings and many others Investment Properties.

**BROKER: 718-717-3074**

### ► QUEENS OPEN HOUSE

**ST. ALBANS OPEN HOUSE**  
**SATURDAY, JUNE 14, 12-3PM**  
**114-12 201st STREET**

Great Opportunity to Own this Fabulous 1-Family, 3 Bedrm Brick Tudor. Gorgeous New Kitchen/ Bath, Finished Basement w/Sep Entrances & Bath, Private Parking.  
**SELLER TO PAY ALL CLOSING COSTS!**  
**\$12,000 Down Payment Buys This House!**  
**EXCEPTIONAL VALUE- MUST SEE!**  
**\$345,000**



**Call Mr. Paul:**  
**631-972-4045**  
**Paul Rizzo/Brooklyn Realty Group, LLC**

### ► REAL ESTATE SERVICES

**SONYMA**

**If You're Ready to Buy a Home, We Are Ready to Help.**

The State of New York Mortgage Agency offers:  
**Up to \$15,000 of Down Payment Assistance**

**1-800-382-HOME(4663)**  
**www.sonyma.org**

**NY WORKS**  
 for Homebuyers

Homes & Community Renewal

**Jamaica West Indies**  
 Fantastic 4 bedroom 4 bath hot water and a/c incl. in Hague near Falmouth jawi only \$ 210K US for more info call 347-219-4065 or 876-381-3723

### ► QUEENS HOUSE FOR SALE

**ST. ALBANS**  
 Newly Renov 4 BR, 3 Bth, Prvt Driveway, Kit w/ new appls, fin bsmt w/ outside entrance. Beautiful Block.  
**Only \$12,500 Needed!**  
**CALL HENRY:**  
**917-705-0539**

### ► FLORIDA HOUSE FOR SALE

Sebastian, Florida Beautiful 55+ manufactured home community, 4.4 miles to the beach, 2 miles to the riverfront district. Homes starting at \$39,000.  
 7 7 2 - 5 8 1 - 0 0 8 0 ,  
[www.beach-cove.com](http://www.beach-cove.com).

**FLORIDA HOMES & CONDOS**  
**NOW STARTING AT \$49,900**  
**NO QUALIFYING**

Call About Our Fly & Buy Program

**No Credit? Bad Credit? NO PROBLEM!**

**1-855-727-2683**  
 Florida Properties of Ocala, Inc.

### ► REAL ESTATE SERVICES

### ► NORTH CAROLINA HOUSE FOR SALE

**Outer Banks, NC Vacation Homes!**

**Brindley Beach**  
 VACATIONS & SALES

Over 500 Vacation Homes, from Duck to Corolla, Oceanfront to Soundfront, Private Pools, Hot Tubs, Pets and More...

Book Online at [www.brindleybeach.com](http://www.brindleybeach.com)  
**1-877-642-3224**  
 "SERVICE FIRST... FUN ALWAYS!"

### ► HANDYMAN

## APPLIANCE REPAIR SERVICE

**CASC Corp.**  
**Appliance Sick? Call us Quick!**

- Stoves • Ovens • Washers • Dryers
- Dishwashers
- Air Conditioners • Deep Fryers • Ice Makers

We Service All Restaurant Equipment  
 Expert Boiler Repairs

**"Don't Throw it Away, We Will Fix it Today"**  
 All Work Guaranteed  
**SAM 718-773-1111 • 917-287-5027**

### ► NYS LOTS & ACREAGE

**TROUT STREAM BAR-GAIN.** 5.4 acres, \$49,900. Was \$199,900. Bank ordered sale. Beautiful Bethel NY. Near Woodstock site. 85 miles from Manhattan. Assorted hardwoods, approved building site, underground utilities, across from lake, walk to Performing Arts Center, financing. Call 877-836-1820.

### ► AUTOS FOR SALE

1997 Cadillac El Dorado Running in Good Condition \$4250 neg.  
 As Is  
 917-379-7371

### ► AUTOS WANTED

### ► NORTH CAROLINA HOUSE FOR SALE

**2002 Cadillac. 4 Dr Sedan.** Color: Champagne. Very Good Cond. \$6,000 Neg. **OWNER: 718-946-2856 or 917-597-9916**

**2003 Audi Quarto A6 3.0** original owner excellent condition loaded midnight blue 105k miles \$5800 **516-445-7599 or 516-359-8918**

### ► HANDYMAN

### ► AUTOS FOR SALE

2002 Cadillac. 4 Dr Sedan. Color: Champagne. Very Good Cond. \$6,000 Neg. **OWNER: 718-946-2856 or 917-597-9916**

### ► AUTOS WANTED

Donate your car to Wheels For Wishes, benefiting Make-A-Wish. We offer free towing and your donation is 100% tax deductible. Call (855) 376-9474

**DONATE YOUR CAR**  
 Wheels For Wishes benefiting

**MAKE-A-WISH**

Metro New York and Western New York

**100% Tax Deductible**

\*Free Vehicle/Boat Pickup ANYWHERE  
 \*\*We Accept All Vehicles Running or Not

**WheelsForWishes.org** **Call: (917) 336-1254**

**JAMAICA UNIVERSAL ELECTRONICS**  
 170-08 JAMAICA AVE FREE PARKING  
 F TRAIN TO 169 ST.  
**718-725-1335**

**BROOKLYN UNIVERSAL ELECTRONICS**  
 1170 FULTON ST  
 BET. FRANKLIN & BEDFORD  
**718-230-1214**

**FINANCING 0% 1 YEAR FINANCING**  
 FINANCING APPLIED TO THE CREDIT APPROVAL BY GE CAPITAL  
 BE ASSESSED ON YOUR PURCHASE DURING THE PROMOTHIN PERIOD BUT WILL  
 BE CREDITED TO YOUR ACCOUNT IF THE PURCHASE IS PAID IN FULL  
 WITHIN THE PERIOD . ANNUAL PERCENTAGE RATE 21%

# SUMMER BONANZA STARTS TODAY

**AIR CONDITIONER**

**5000BTU**  
**\$89**

**8000 BTU**  
**\$149**

**SONY STEREO Home Theater System**

**\$69**

**\$79**

**CCTV SECURITY SYSTEM KIT**  
**8 CAMARA**

**\$129** **\$189**

**4 CAMERA**

**CCTV400** **CCTV800**

**WE CARRY ALL 220 VOLT PRODUCTS**

**LED, LCD, PLAZMA TV**

**12000BTU**  
**\$189**

**19" TOSHIBA**  
**\$79**

**32" SAMSUNG**  
**\$169**

**46" SONY**  
**\$289**

**43" SAMSUNG**  
**\$219**

**51" SAMSUNG**  
**\$299**

**60" SAMSUNG**  
**\$509**

**55" LN55C450 SAMSUNG**  
**\$399**

**HP**  
 INTEL CORE-DUO  
 6 GB MEMORY  
 750 GB HD  
 DVD RW  
 MONITOR OPTIONAL  
 20" Monitor  
**\$179**

**DELL**  
 INTEL CORE-DUO  
 8 GB MEMORY  
 1 TB HD  
 DVD RW  
 MONITOR OPTIONAL  
 20" Monitor  
**\$219**

**LAPTOP & DESKTOP**

**TOSHIBA**  
 INTEL CORE-DUO  
 4 GB MEMORY  
 500 GB HD  
 DVD RW  
**\$199**

**DELL**  
 6 GB MEMORY  
 640 GB HD  
 DVD RW  
**\$209**

**HP**  
 INTEL CORE-DUO  
 6 GB MEMORY  
 640 GB HD  
 15" SCREEN  
**\$259**

**SONY**  
 INTEL CORE-DUO  
 15.4" SCREEN  
 6 GB MEMORY  
 750 GB HD  
 DVD RW  
**\$299**

**TABLET**  
**ACER TOSHIBA IVIEW APPLE SAMSUNG**

**\$199**

**\$69**  
**Portable DVD**

**\$49**  
**DVD PLAYER**

**\$15**  
**DVD VCR**

**\$39**

**COMPLETE DJ SYSTEM**  
**POWER SPEAKER**

**YAMAHA**  
**\$249**

**SAMSUNG**  
**\$299**

**JBL**  
**\$189**

**PIANO**  
**\$49**

**GUITAR**  
**\$59**

**STUDIO MIXER**  
**\$159**

**GEMINI**  
**\$199**

**NUMARK MIXTRACK**  
**\$129**

**TURN TABLE**  
**\$69**

**INSTALL YOUR CAR STEREO HERE**  
**CAR AMPLIFIER**

**PIONEER**  
**\$39**

**SONY**  
**\$59**

**KECKER**  
**\$79**

**ROCKRORD FOSQARE**

ALL ITEMS FROM UNIVERSAL ELECTRONICS AND APPLIANCES IS RETURNABLE FOR EXCHANGE ONLY WITHIN 10 DAYS. NO REFUNDS. NYC CONSUMER AFFAIRS N.Y.C D.C.A #1307128(BROADWAY), N.Y.C D.C.A #1307857 (QUEENS),N.Y.C D.C.A #1307095(MANHATTAN),N.Y.C. D.C.A #136059 (BROOKLYN),UNIVERSAL ELECTRONICS AND APPLIANCES IS NOT RESPONSIBLE FOR ANY TYPOGRAPHICAL ERRORS. PICTURES ARE FOR ILLUSTRATIVE PURPOSE ONLY & MAY NOT DEPICT ACTUAL ITEMS. ADVERTISED ITEMS ARE LIMITED TO 1 PER FAMILY / GROUP. ALL COMPUTERS MAY REQUIRE ASSEMBLY CONFIGURATIONS. QUANTITIES ARE LIMITED. ALLOW TWO TO THREE WEEKS FOR DELIVERY ON ALL TV'S PRICE DOES NOT INCLUDE DELIVERY. AD EXPIRES ON AUGUST 2, 2014.